

Finish (Part Number)

Size	Mill	Bronze	White
Flush *	L-5500	L-5583	L-5608
1/16" *	L-5501	L-5584	L-5609
1/8" *	L-5502	L-5585	L-5610
3/16" *	L-5549	L-5586	L-5611
1/4" *	L-5550	L-5587	L-5612
5/16" **	L-5503	L-5588	L-5613
3/8" **	L-5504	L-5589	L-5614
7/16" **	L-5505	L-5590	L-5615
1-3/16" **	L-5606	L-5607	L-5616

*No. 8 Phillips pan head sheet metal screws.
 **No. 10-24 Phillips pan head machine screws.

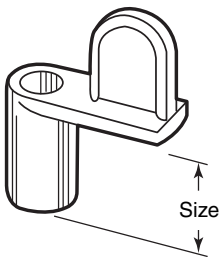

**Special
For Hawaii**

L-5557

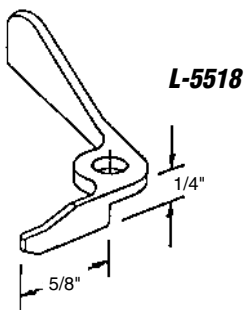
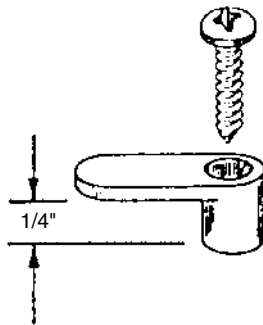

Diecast Clips

Contents: 12 clips with installation screws.

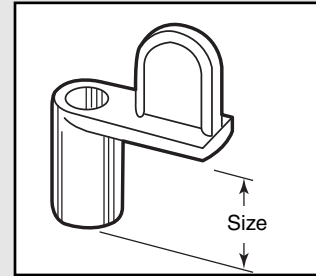

Description: Painted and plated clips used to attach screen to window opening.

NOTE: Also available in bulk (1000/ctn.)
Almond & Adobe available in bulk only.

Diecast Clips (Special)

Contents: 12 clips with #8 x 1" Phillips pan head sheet metal screws.

Finish (Part Number)

Size	Mill	Bronze	White
5/16"	L-5665	L-5668	L-5674
3/8"	L-5666	L-5669	L-5675
7/16"	L-5667	L-5670	L-5676

Description: Painted and plated clips; supplied with 1" long sheet metal screws for Hawaii installations.

L-5557 (1/4")

Diecast Clips

Contents: 12 clips with #8 x 3/4" Phillips pan head sheet metal screws.

Description: Flat top style clips used to attach screen to window opening.

L-5518

*Call for
Availability*

Diecast Clips

Contents: 6 clips with #4 x 3/8" Phillips pan head sheet metal screws.

Description: Lever style clip used to attach screen to window opening.

Window Screen Hardware

Plastic Clips

Contents: 12 clips with installation screws.

Color (Part Number)

Size	Gray	Black	White	Bronze
1/16" *	L-5507	L-5718	L-5721	L-5724
1/8" *	L-5679	L-5719	L-5722	L-5725
3/16" *	L-5508	L-5720	L-5723	L-5726
5/16" **	L-5509	L-5570	L-5573	L-5727
3/8" **	L-5510	L-5571	L-5574	L-5728
7/16" **	L-5511	L-5572	L-5575	L-5729

Description: Clips in various colors used to attach screen to window opening.

*No. 8 Phillips pan head **sheet metal screws**.

No. 10-24 Phillips pan head **machine screws.

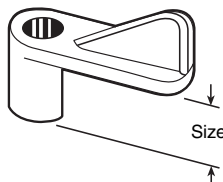

- L-5671** (5/16")
- L-5672** (3/8")
- L-5673** (7/16")

Plastic Clips (Gray)

Contents: 12 clips with #8 x 1" Phillips pan head sheet metal screws.

Description: Clips are supplied with **1" long screws** for **Hawaii** installations.



**Special
For Hawaii**

- L-5671**
- L-5672**
- L-5673**

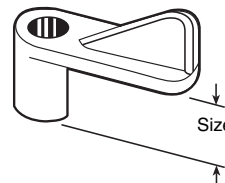

- L-5517** (White)
- L-5664** (Black)

Flush Clips (Plastic)

Contents: 12 clips with #6 x 5/8" Phillips pan head sheet metal screws.

Description: **Double wing** flush clips used to attach screens and storm windows to window opening.



- L-5517**
- L-5664**

Flush Clips (Plastic)

Contents: 12 clips with #8 x 3/4" Phillips pan head sheet metal screws.

Color	Part Number
White	L-5506
Brown	L-5569
Black	L-5630
Gray	L-5680

Description: Clips are supplied with screws, used to attach screens and storm windows to window opening.

- L-5506**
- L-5569**
- L-5630**
- L-5680**

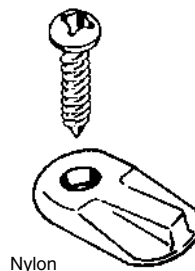

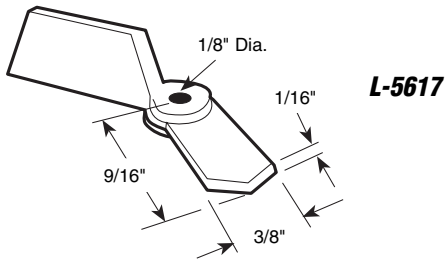

L-5617

Turn Buttons (White plastic)

Contents: 12 turn buttons with #4 x 3/4" Phillips pan head sheet metal screws.

Description: Turn buttons used to attach screens and storm windows to window opening.

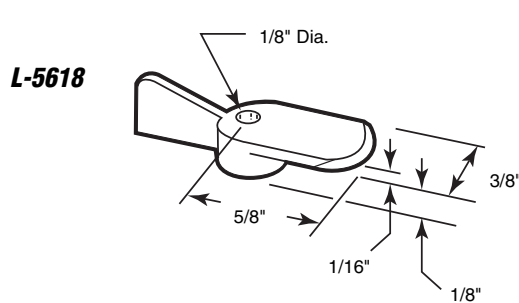

L-5618

Swivel Clips (White nylon)

Contents: 12 clips with #8 x 3/4" Phillips pan head sheet metal screws.

Description: Swivel clips used to attach screens and storm windows to window opening.

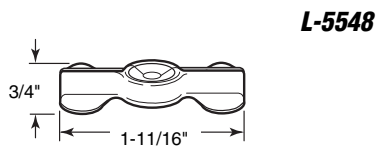

L-5548

Flush Clips

Contents: 6 clips with #8 x 1/2 flat head sheet metal screws.

Description: Nickel plated steel, double wing clips used to attach screens and storm windows to window opening; also applied to narrow rails to hold adjacent screens in place.

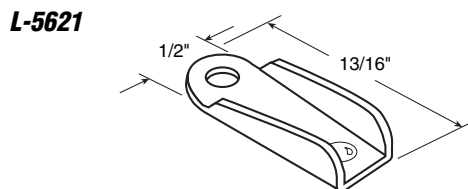

L-5621

Wing Clips

Contents: 12 clips with #8 x 3/4" Phillips pan head sheet metal screws.

Description: Stamped aluminum clips used to attach screens and storm windows to window opening.

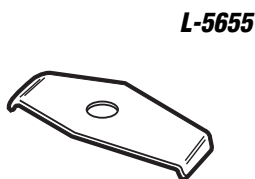

L-5655

Metal Clips

Contents: 12 clips with #8 x 3/4" Phillips pan head sheet metal screws.

Description: Stamped aluminum, double wing clips commonly applied to narrow rails on interior of double casement windows to hold adjacent screens in place.

L-5656



L-5656

Metal Clips

Contents: 12 clips with #8 x 3/4" Phillips pan head sheet metal screws,

Description: Stamped aluminum clips used with L-5655 on casement window applications and other similar flush mount applications..

Window Screen Hardware

L-5706 (Black)
L-5707 (White)

Nylon Clips

Contents: 4 clips with #6 x 5/8" round washer head machine screws.

Description: Clips used to attach screens to **Acorn** windows.

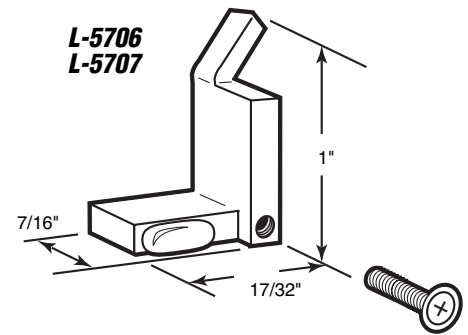

L-5512 (5/16")
L-5513 (3/8")
L-5514 (7/16")
L-5515 (7/8")
L-5516 (1-3/16")

Casement Clips (Aluminum)

Contents: 12 clips with #10-24 Phillips pan head machine screws.

Description: Casement clips used to secure window screens and storm windows to window or storm door openings.

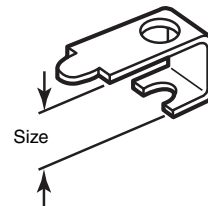

L-5512
L-5513
L-5514
L-5515
L-5516

L-5519

Retainer Clips (Spring steel)

Contents: 6 clips.

Description: Retainer clips hold **3/8" screen frame** into aluminum window channel; **bright finish**.

L-5519

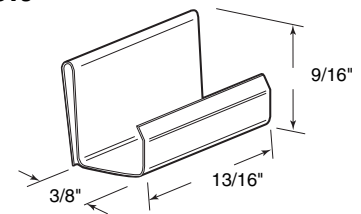

L-5520

Retainer Clips (Spring steel)

Contents: 6 clips.

Description: Retainer clips hold **7/16" screen frame** to aluminum window channel; **bright finish**.

L-5520

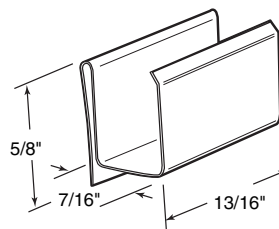

L-5521

Retainer Clips (Vinyl)

Contents: 6 clips.

Description: **Black vinyl** clips are used to hold **3/8" and 7/16" screen frame** into aluminum window channel.

L-5521

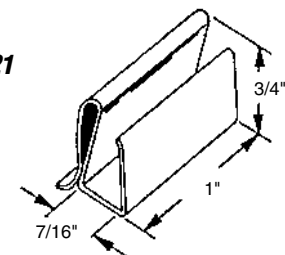

L-5603

Retainer Clips (Vinyl)

Contents: 6 clips

Description: **Black vinyl** clips are used to hold **3/8" screen frame** into aluminum window channel; fits on **Tom Ray** windows.

L-5603

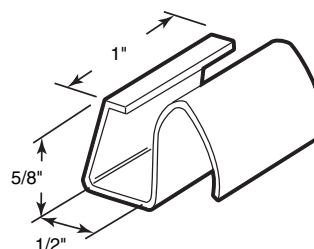

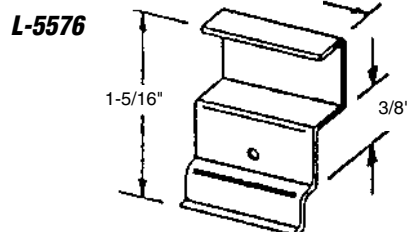
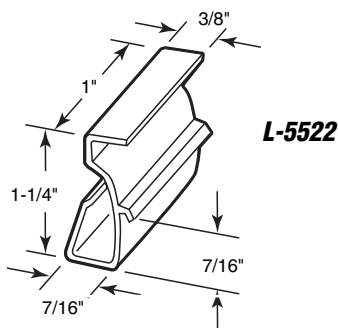
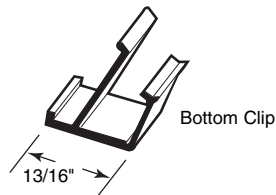
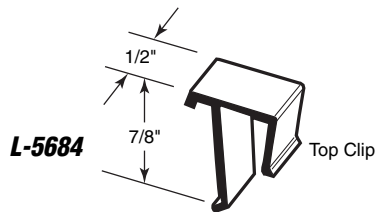
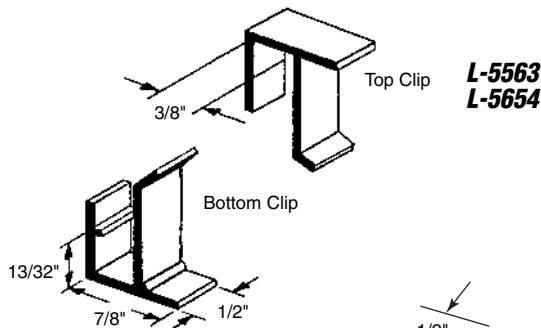
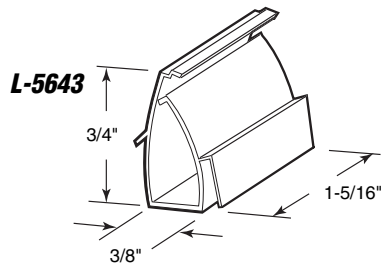
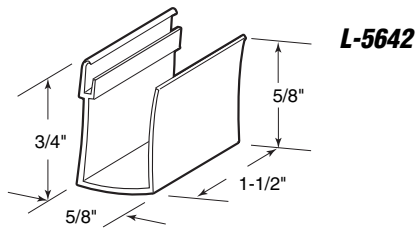

L-5642

Retainer Clips (Vinyl)

Contents: 6 clips.

Description: Black vinyl clips are used to hold screen frame into aluminum window channel; fits on "Old Style" *Better Built* windows.

L-5643

Retainer Clips (Vinyl)

Contents: 6 clips.

Description: Black vinyl clips are used to hold screen frame into aluminum window channel; fits on "New Style" *Better Built* windows.

L-5563 (2 sets/card)

L-5654 (4 sets/card)

Retainer Clips (Vinyl)

Contents: 1 set = 1 top clip and 1 bottom clip.

Description: Black vinyl clips hold screen frame into sliding window frame channel; fits on *H&D Industries* for 7/16" frame. Very popular in the Northwest.

L-5684

Retainer Clips (Vinyl)

Contents: 4 top and 4 bottom clips.

Description: Black vinyl clips hold screen frame into sliding window frame channel; for 3/8" frame.

L-5522

Lift and Retainer Clips (Vinyl)

Contents: 6 clips

Description: Black vinyl clips used to hold 3/8" screen frame into aluminum window channel; lift tab assists in screen removal.

L-5576

Lift and Retainer Clips (Aluminum)

Contents: 6 clips with installation screws.

Description: Stamped aluminum clip used as a lift handle and screen frame retainer on sliding aluminum windows.

Window Screen Hardware

L-5523

Lift Tabs (Plastic)

Contents: 6 tabs.

Description: **Black vinyl** lift tabs used to aid in removal of **7/16" window screen** from window frame.

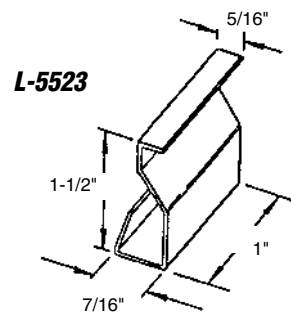

L-5524

Lift Tabs (Metal)

Contents: 6 tabs.

Description: **Stamped aluminum** lift tab is installed in spline channel to aid in removal of window screen from window frame.

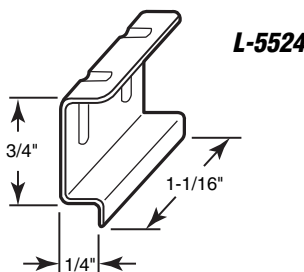

L-5525 (White)

L-5566 (Black)

L-5677 (Gray)

Lift Tabs (Plastic)

Contents: 6 tabs.

Description: **Plastic** lift tab is installed in spline channel to aid in removal of window screen from window frame.

L-5525 L-5566 L-5677

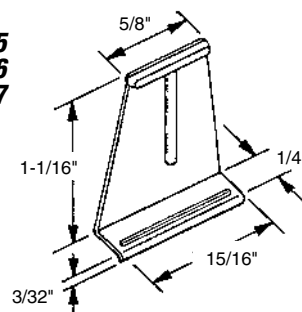

L-5685

Lift Tabs (Plastic)

Contents: 6 tabs.

Description: **Deluxe black plastic** lift tab is installed in spline channel to aid in removal of window screen from window frame.

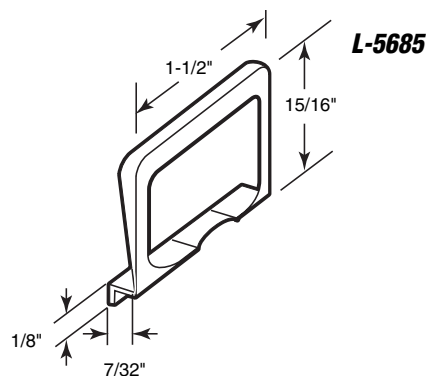

L-5686 (Gray)

L-5687 (Black)

Lift Tabs (Vinyl)

Contents: 6 tabs.

Description: **Vinyl** lift tab may be installed in most sizes of spline channel to aid in removal of window screen from window frame.

L-5686 L-5687

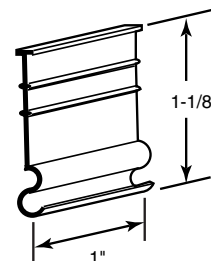

Stretcher Clips

Contents: 12 clips; 12 - #10 x 3/8" Phillips pan head sheet metal screws.

Part #	Frame Application
L-5578	3/8" x 5/8" flanged frame
L-5579	5/16" x 3/4" frame
L-5580	3/8" x 3/4" frame
L-5581	7/16" x 11/16" frame
L-5582*	For "Miami" Windows
L-5596	1/4" x 3/4" frame
L-5597	For flanged frame
L-5598	For "Keller" windows - old style
L-5599	For "Keller" windows - new style
L-5600	"Z" clips with 1/8" offset
L-5602	1/4" x 11/16" frame
L-5622	3/8" x 13/16" flanged frame
L-5678	For recessed frame
L-5682	3/8" x 5/8" frame

Description: Stamped aluminum clips for attaching window screens to awning and other types of windows.

*Installation screws are not required for this item.

L-5578

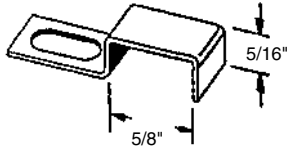

L-5579

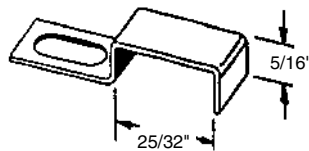

L-5580

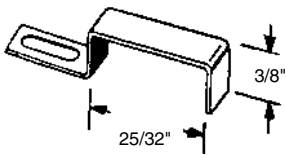

L-5581

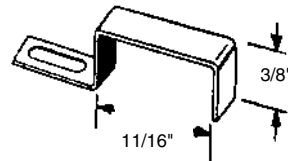

L-5582

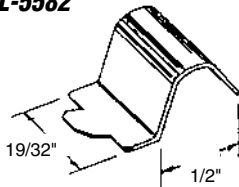

L-5596

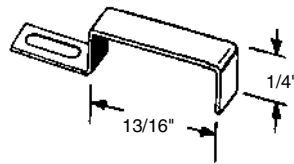

L-5597

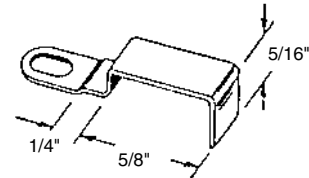

L-5598

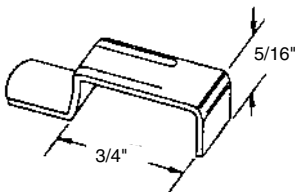

L-5599

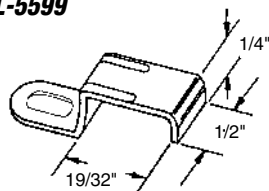

L-5600

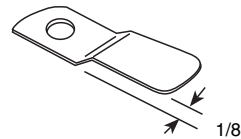

L-5602

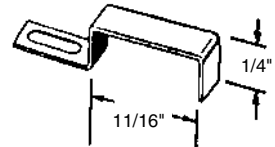

L-5622

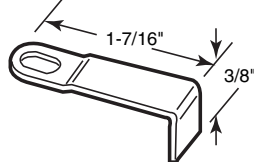

L-5678

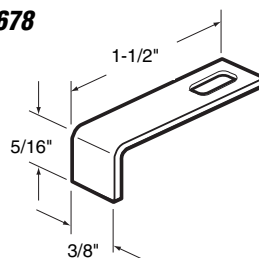

L-5682

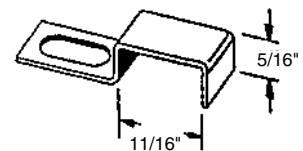

Plunger Latches

Contents: 6 latch assemblies.

Part #	Plunger	Cap	Screen Frame
L-5539	Nylon	Nylon	1/4" or 5/16" x 3/4"
L-5540	Nylon	Nylon	3/8" or 7/16" x 3/4"
L-5541	Diecast	Nylon	3/8" or 7/16" x 3/4"
L-5542	Diecast	Nylon	7/16" x 1"
L-5555	Aluminum	Aluminum	5/8"
L-5631	Aluminum	Aluminum	7/16" x 3/4"
L-5632	Aluminum	Aluminum	7/16" x 1"

Description: Spring loaded plunger latches hold aluminum frame screens into window frames.

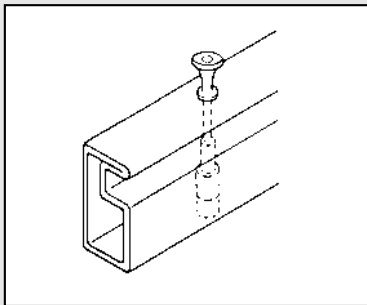

Note: For new installations, see **part no. L-5628** on **page L-12**. This **step drill** may be used for drilling screen frame for all plunger latches except **part no. L-5539**.

- L-5536** (For 5/8" frame) - 3/32"
- L-5537** (For 3/4" frame) - 1/8"
- L-5538** (For 1" frame) - 1/8"

Lock Pins

Contents: 6 pins.

Description: Plated steel pin used to secure window screens to sliding aluminum windows.

- L-5545** (1-1/2" long)
- L-5559** (1-13/32" long)

Slide Locks

Contents: 6 locks.

Description: Stamped aluminum locks used to attach window screens to aluminum window channels.

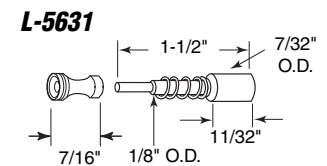
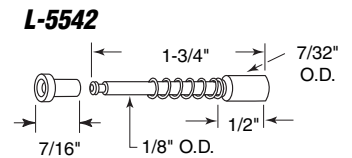
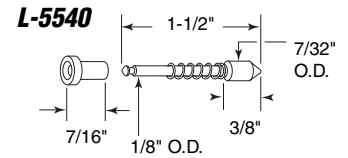
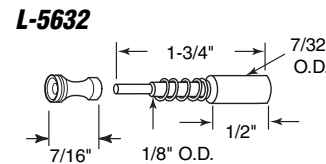
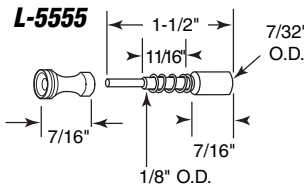
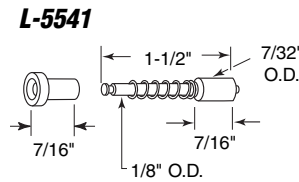
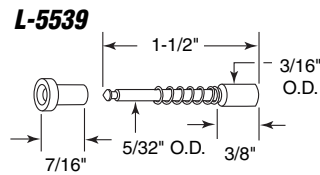

L-5536
L-5537
L-5538

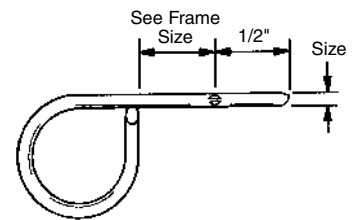

L-5545
L-5559

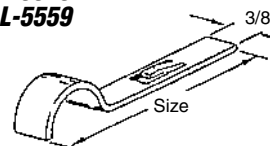

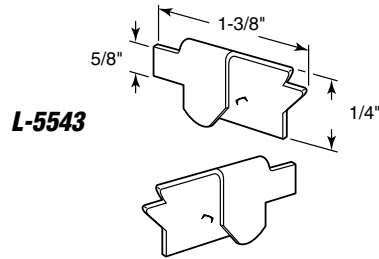

L-5543

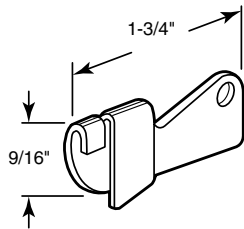

L-5544

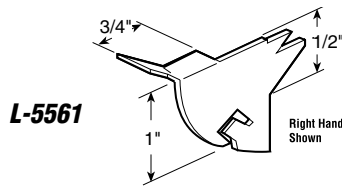

L-5561

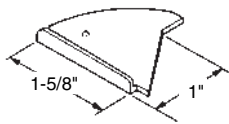

L-5562

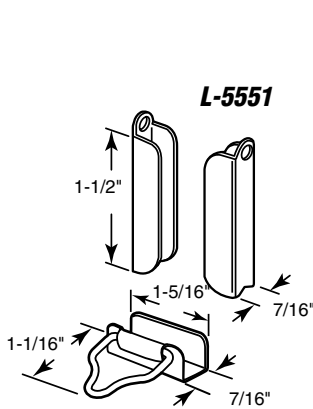

L-5551

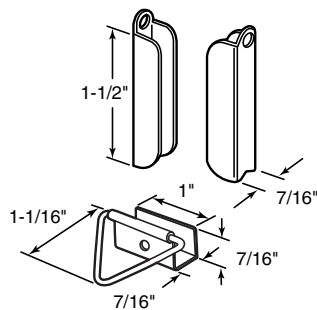

L-5529
CCEP-5529

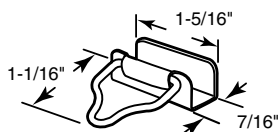

L-5553

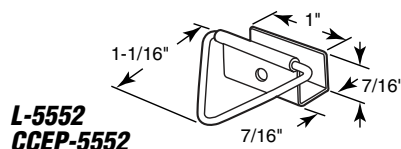

L-5552
CCEP-5552

- L-5543** (Snap-on)
- L-5544** (Rivet-on)
- L-5561** (Swivel)
- L-5562** (Swivel)

Knife Latches

Contents: 3 left hand & 3 right hand latches.

Description: Stamped aluminum latches used to secure window screens to sliding aluminum window frames.

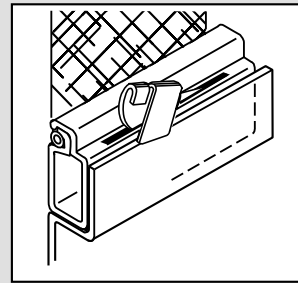

Clasp Latching

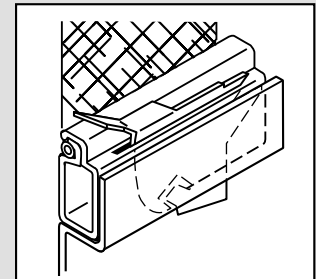

Slot Latching

- L-5529** (Mill finish)*
- L-5551** (Painted gray)

Hangers and Latches

Contents: 4 top hangers; 2 bottom latches; 2 ball head screws.

Description: Stamped aluminum hardware used to install 7/16" thick window screens to wood framed windows; the contents will accommodate installation of (2) window screens.

*Bulk: CCEP-5529 (2 sets/bag) 50 bags/box.

- L-5552** (Mill finish)*
- L-5553** (Painted gray)

Bottom Latches

Contents: 4 latches; 4 ball head screws.

Description: Stamped aluminum latches slip-on to bottom of 7/16" thick frame; used to hold bottom of window screen to wood window sill.

*Bulk: CCEP-5552 (4/bag) 100 bags/box.

Window Screen Hardware

L-5554

Spline Latch

Contents: 4 latches; 4 ball head screws.

Description: Stamped aluminum latch is installed into spline channel of window screen; used to hold bottom of screen to wood-framed window sill.

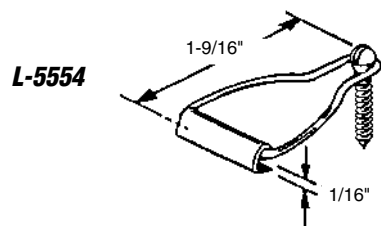

L-5560 (Aluminum)

L-5683 (White)

Top Hangers

Contents: 6 hangers; 6 nails.

Description: Stamped mill finish and white painted aluminum hangers nail into top corners of wood window frame; used to hold 7/16" thick screen frame to window frame and allow for easy removal.

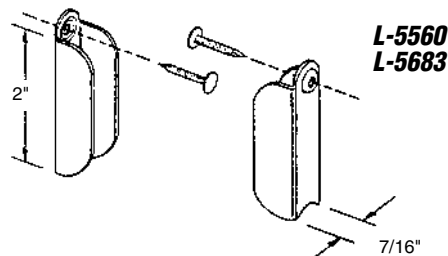

L-5567

Nail Set Tool

Contents: 1 tool.

Description: Plated steel tool used to install nails into wood framed windows using L-5529, L-5551, L-5560 hangers.

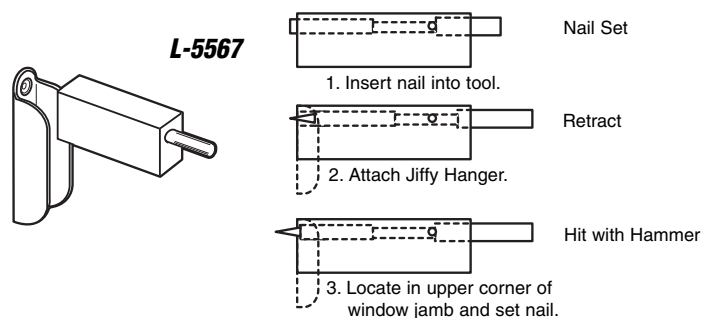

PL-14705 (100/tub)

PL-14706 (1000/tub)

Ball Head Screws

Contents: Bulk screws in plastic tub.

Description: Plated steel screws are used with bottom latches L-5552, L-5553 & L-5554 to hold window screen to wood window sill; no. 8 x 1" ball head screw.

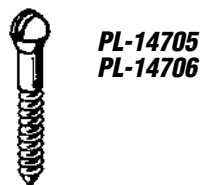

PL-14732

Self-Tapping Screws

Contents: 100 bulk screws in plastic tub.

Description: 10-24 x 3/4" Phillips pan head self-tapping machine screw; used to attach screen clips onto steel window frames.

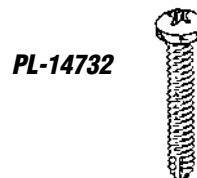

L-5623 (523)

L-5624 (524)

L-5625 (525)

L-5626 (1029)

Retainer Clips

Contents: 4 clips.

Description: Clear plastic clips; used exclusively in Western Canada to hold window screens to sliding window frames; use number molded into plastic part for exact replacement.

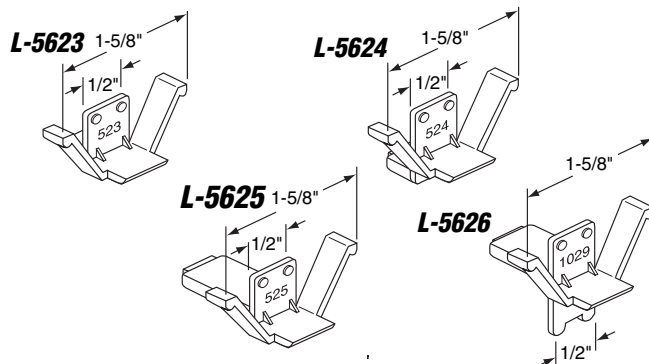

L-5532

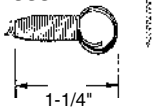

L-5658

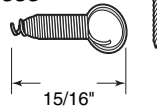

L-5659

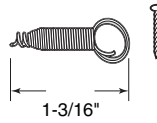

L-5660

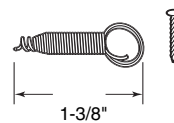

L-5534

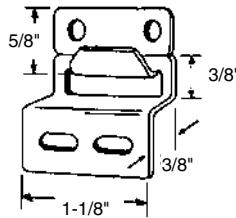

L-5661

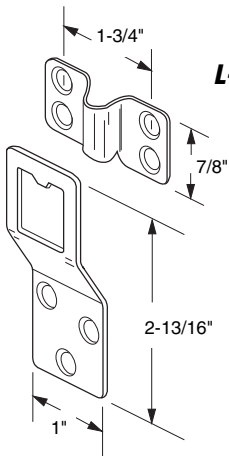

L-5568

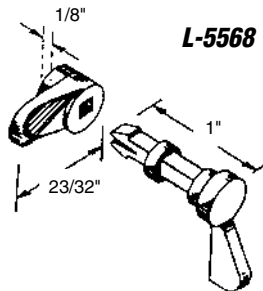

L-5527

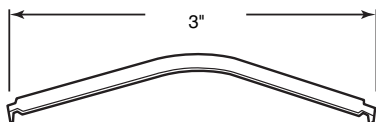

L-5629

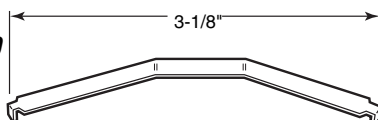

L-5532 (Plated steel)

L-5658 (Stainless steel)

L-5659 (Stainless steel)

L-5660 (Stainless steel)

Spring Latches

Contents: 6 springs; 6 nails.

Description: Spring steel latches are used to hold bottom of window screen to wood framed window sill. Aluminum nail is driven part-way into sill and spring loop is pulled over nail.

L-5534

Top Hangers

Contents: 4 hooks; 4 keepers; 4 sets of installation screws.

Description: Stamped aluminum hardware; used on wood framed windows; top mounted; hooks mount to window frame and keepers mount to screen frame.

L-5661

Top Hangers

Contents: 2 hooks; 2 keepers; 2 sets of installation screws.

Description: Plated steel hardware; used on wood framed windows; top mounted; hooks mount to window frame and keepers mount to screen frame.

L-5568

Retainer Clip Assemblies

Contents: 6 clips; 6 lock pins.

Description: Plastic assembly fits on Arcadia 770 and 780 Series windows; holds screen frame to window frame.

L-5527 (Round top)

L-5629 (Flat top)

Tension Springs

Contents: 6 springs.

Description: Heat-treated steel tension springs hold window screens into sliding aluminum window screen channels. Requires two (2) 3/16" holes drilled 3-3/16" apart.

Window Screen Hardware

L-5577 (1/4" wide)
L-5605 (3/16" wide)

Tension Springs

Contents: 6 springs.

Description: Heat-treated steel tension springs hold window screens into sliding aluminum window screen channels. Slips into corner of 3/8" or 7/16" frame. No tools required.

L-5528
L-5620 (Heavy Duty)

Tension Springs

Contents: 12 springs.

Description: Plated steel spring wire; designed to hold window screens into sliding aluminum window screen channels.

L-5535

Hook & Eye

Contents: 2 hooks; 2 eyes.

Description: Plated steel hook and eye; used as a bottom latch on traditional wood frame window screens.

L-5604

Clips

Contents: 4 clips.

Description: Stamped aluminum clips used for mounting window screens and storm panels to window frames.

L-5628

Step Drill

Contents: 1 drill.

Description: Specially designed step drill is used to install a variety of plunger latches (see page L-8).

You may also wish to stock these related parts: L-5539, L-5540, L-5541, L-5542, L-5555, L-5627.

L-5577
L-5605

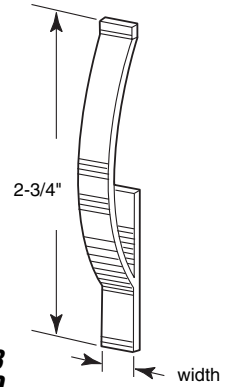

L-5528
L-5620

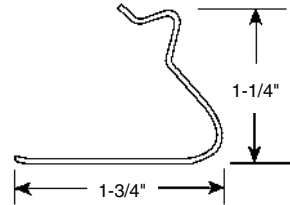

L-5535

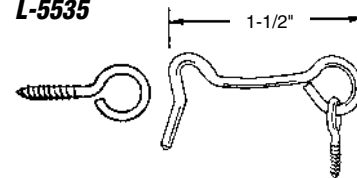

L-5604

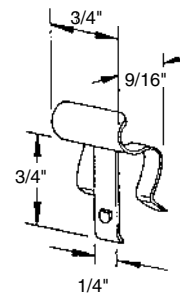

L-5628

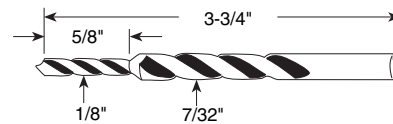

Also Available:

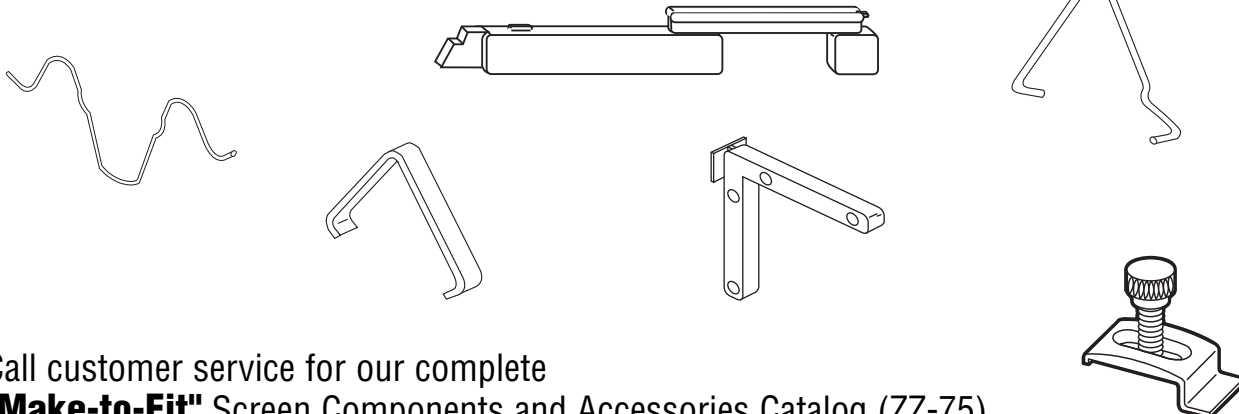

Call customer service for our complete
"Make-to-Fit" Screen Components and Accessories Catalog (ZZ-75).

PL-7724
PL-7725
PL-7726

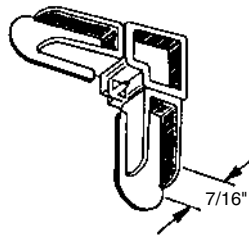

PL-7724 (Gray)
PL-7725 (Bronze)
PL-7726 (White)

7/16" x 3/4" Screen Frame Corners (Plastic)

Contents: 4 corners.

Description: Plastic corners used with appropriate screen frame to form a finished window screen. These corners allow frame to be square cut for easy construction by homeowner.

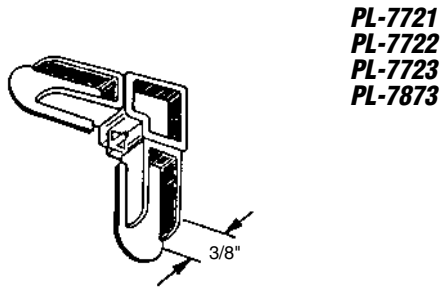

PL-7721
PL-7722
PL-7723
PL-7873

PL-7721 (Gray)
PL-7722 (Bronze)
PL-7723 (White)
PL-7873 (Almond)

3/8" x 3/4" Screen Frame Corners (Plastic)

Contents: 4 corners.

Description: Plastic corners used with appropriate screen frame to form a finished window screen. These corners allow frame to be square cut for easy construction by homeowner.

PL-7727
PL-7728
PL-7729
PL-7871

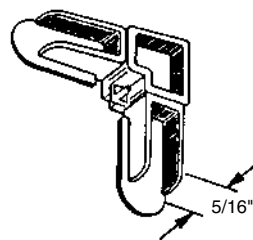

PL-7727 (Gray)
PL-7728 (Bronze)
PL-7729 (White)
PL-7871 (Almond)

5/16" x 3/4" Screen Frame Corners (Plastic)

Contents: 4 corners.

Description: Plastic corners used with appropriate screen frame to form a finished window screen. These corners allow frame to be square cut for easy construction by homeowner.

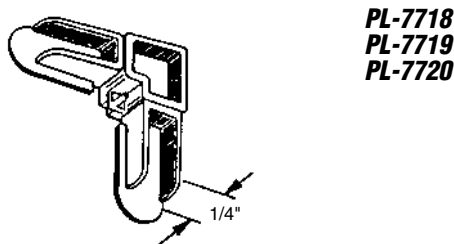

PL-7718
PL-7719
PL-7720

PL-7718 (Gray)
PL-7719 (Bronze)
PL-7720 (White)

1/4" x 3/4" Screen Frame Corners (Plastic)

Contents: 4 corners.

Description: Plastic corners used with appropriate screen frame to form a finished window screen. These corners allow frame to be square cut for easy construction by homeowner.

P-7501

Rolling Tool

Contents: 1 tool.

Description: Combination tool with **plastic** handle; **steel** convex and concave rollers; used to **install aluminum screen wire** and vinyl spline into window screen frame.

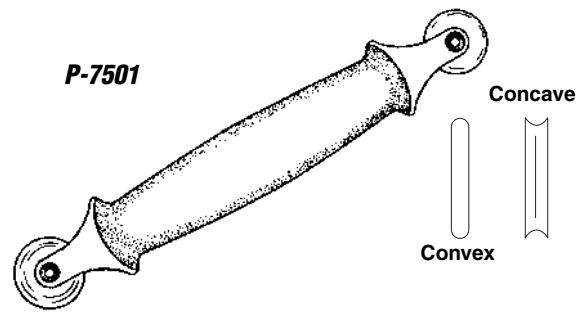

P-7503 (Carded)

CCBP-7503 (Bulk - 40 per box)

Rolling Tool

Contents: 1 tool.

Description: Combination tool with **plastic** handle; **nylon** convex and concave rollers; used to **install fiberglass screen fabric** and vinyl spline into window screen frame.

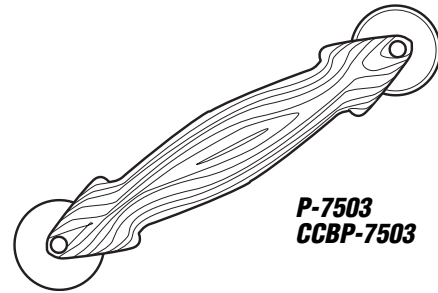

P-7505 (Carded)

CCBP-7505 (Bulk - 50 per box)

Rolling Tool

Contents: 1 tool.

Description: Combination tool with **wood** handle; **steel** convex and concave rollers; used to install most screening materials and vinyl spline into window screen frame.

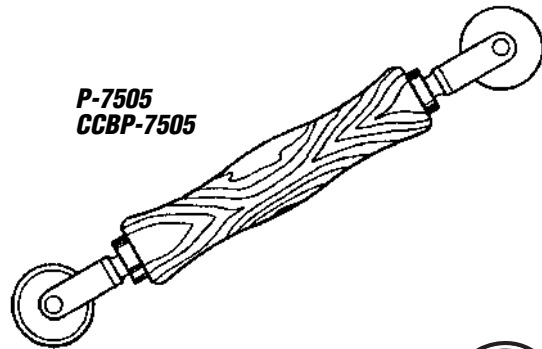

P-7506

Rolling Tool

Contents: 1 tool.

Description: Combination tool with **diecast zinc** handle; **steel** convex and concave rollers; used to install most screening materials and vinyl spline into window screen frame.

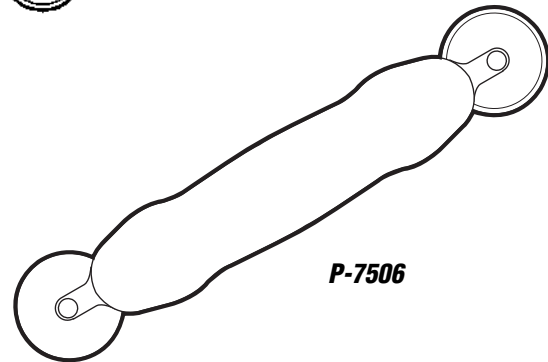

P-7508

Rolling Tool

Contents: 1 tool.

Description: Combination tool with **wood** handle; **steel ball bearing** convex and concave rollers; used to install most screening materials and vinyl spline into window screen frame.

Many styles of professional rolling tools are available. Call our customer service specialists or order our "Expert's Back Room" catalog.

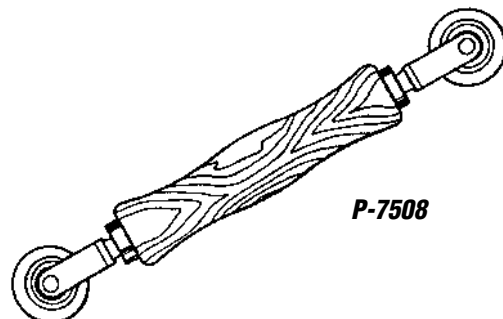

P-7510
P-7540

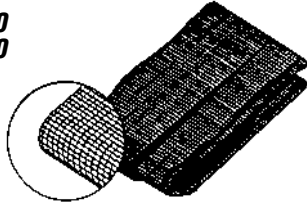

P-7511
P-7541

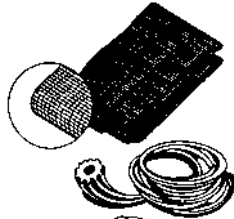

P-7515
P-7542

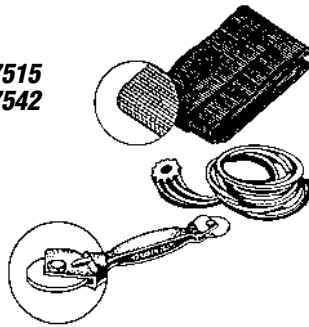

P-7548
P-7549

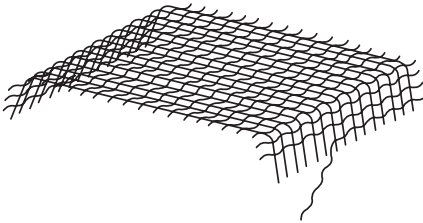

P-8093

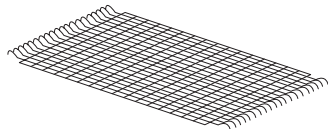

P-8095
P-8096

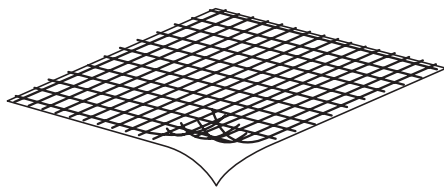

P-7510 (36" x 84")
P-7540 (48" X 84")

Fiberglass Screen

Contents: 1 piece of screen fabric.

Description: Charcoal fiberglass used for re-screening projects; may be sufficient quantity to re-screen (2) windows or (1) door.

P-7511 (36" x 84")
P-7541 (48" X 84")

Fiberglass Screen Kit (Western U.S.)

Contents: 1 piece of screen fabric; 30' of .180 black vinyl spline; rolling tool.

Description: Charcoal fiberglass and vinyl spline used for re-screening projects; plastic handled combination rolling tool with nylon convex and concave rollers, maybe sufficient quantity to re-screen (2) windows or (1) door.

P-7515 (36" x 84")
P-7542 (48" X 84")

Fiberglass Screen Kit (Eastern U.S.)

Contents: 1 piece of screen fabric; 30' of .155 black vinyl spline; rolling tool.

Description: Charcoal fiberglass and vinyl spline used for re-screening projects; plastic handled combination rolling tool with nylon convex and concave rollers, maybe sufficient quantity to re-screen (2) windows or (1) door.

P-7548 (Aluminum finish - bagged)
P-7549 (Charcoal finish - carded)
P-8098 (Aluminum finish - carded)

Screen Repair Patches (3" x 3")

Contents: 5 aluminum screen patches.

Description: Repair patches cover holes in existing aluminum screened windows or doors; **no tools required.**

P-8093 (Aluminum finish)

Screen Repair Patches (1-1/2" x 1-3/4")

Contents: 7 aluminum screen patches.

Description: Repair patches cover holes in existing aluminum screened windows or doors; **no tools required.**

P-8095 (Gray)
P-8096 (Charcoal)

Screen Repair Patches (3" x 3")

Contents: 5 fiberglass screen patches.

Description: Adhesive backed fiberglass patches used to repair holes and tears in window screens or screen doors; **no tools required.**

Screen Retainer Spline

Contents: 25 feet per display bag.

Part Number Black	Part Number Gray	Decimal Size	Fractional Size
P-7516	P-7630	.120	1/8"
P-7517	P-7631	.130	-
P-7518	P-7632	.135	-
P-7519	P-7633	.140	9/64"
P-7533	P-7634	.150	-
P-7520	P-7635	.155	-
P-7521	P-7636	.165	11/64"
P-7522	P-7637	.170	-
P-7523	P-7638	.175	-
P-7524	P-7639	.180	-
P-7940	P-7941	.185	3/16"
P-7525	P-7640	.190	-
P-7950	P-7951	.195	-
P-7526	P-7641	.200	13/64"
P-7527	P-7642	.210	7/32"
P-7960	P-7961	.215	-
P-7528	P-7643	.220	-
P-7970	P-7971	.225	-
P-7529	P-7644	.230	15/64"
P-7980	P-7981	.235	-
P-7530	P-7645	.250	1/4"
P-7531	P-7646	.260	-
P-7532	P-7647	.270	17/64"

Description: Top quality vinyl; round; hollow core and serrated; used to hold screen material to window and screen door frames. Also available in 100 ft, 250 ft, 500 ft, and 15 lbs. bulk reels.



Actual Sizes

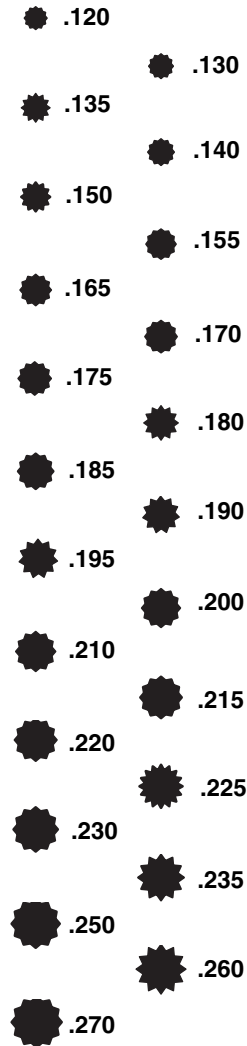

Glazing Channel

Contents: 20 feet per bag.

	Channel Size		Glass Thickness	Part Number
	"A"	"B"		
	1/4"	1/4"	Single	P-7616
	17/64"	1/4"	Single	P-7617
	1/4"	1/4"	Double	P-7618
	17/64"	1/4"	Double	P-7619

Description: Black vinyl glazing channel; universal size to fit many window frame glass channels. Determine glass channel dimensions and thickness of glass to select proper glazing channel. Also available in many other sizes as well as lengths of 100 ft, 200 ft and bulk reels.

P-7616
P-7617
P-7618
P-7619

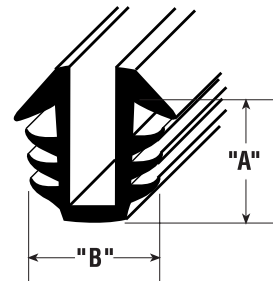

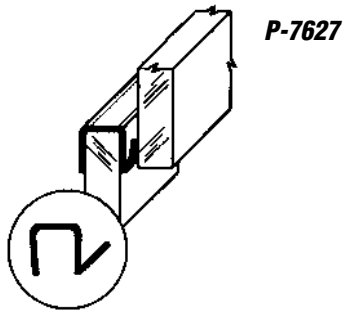

T-8658
T-8659

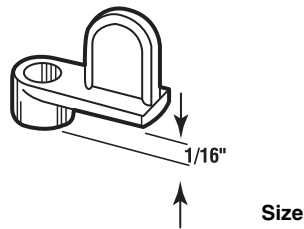
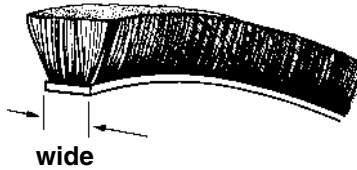

NOTE: Also available in bulk (1000/ctn.)
Almond & Adobe available in bulk only.

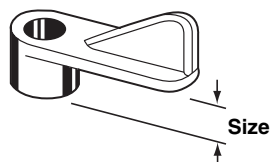
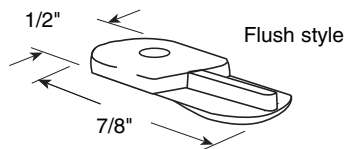

P-7627

Louver Strip

Contents: 20 feet per bag.

Description: Clear vinyl strip; slips over 3/16" louver glass to reduce air and dust infiltration.

T-8658 (3/16" wide)
T-8659 (1/4" wide)

Pile Weatherstrip

Contents: 18 feet per bag.

Description: Brush weatherstrip with stiff backer; used by many window manufacturers to seal out air and dust. **Also available in bulk lengths.**

Screen Clips (Diecast)

Contents: 12 clips with installation screws.

Size	Finish (Part Number)			
	Mill	Black	White	Bronze
Flush *	PL-7730	PL-7877	PL-7878	PL-7879
1/16" *	PL-7731	PL-7880	PL-7881	PL-7882
1/8" *	PL-7732	PL-7883	PL-7884	PL-7885
3/16" *	PL-7733	PL-7886	PL-7887	PL-7888
1/4" *	PL-7734	PL-7889	PL-7890	PL-7891
5/16" **	PL-7735	PL-7842	PL-7893	PL-7894
3/8" **	PL-7736	PL-7843	PL-7896	PL-7897
7/16" **	PL-7737	PL-7844	PL-7899	PL-7900
1-3/16" **	PL-7901	PL-7902	PL-7903	PL-7904

* No. 8 Phillips Pan Head Sheet Metal Screws.

** No. 10-24 Phillips Pan Head Machine Screws.

Description: Painted and plated clips used to attach screen to window opening.

Screen Clips (Plastic)

Contents: 12 clips with installation screws.

Size	Finish (Part Number)			
	Gray	Black	White	Bronze
Flush *	PL-7905	PL-7906	PL-7738	PL-7907
1/16" *	PL-7739	PL-7908	PL-7909	PL-7910
3/16" *	PL-7740	PL-7911	PL-7912	PL-7913
1/4" *	PL-7914	PL-7788	PL-7790	PL-7915
5/16" **	PL-7741	PL-7770	PL-7773	PL-7916
3/8" **	PL-7742	PL-7771	PL-7774	PL-7917
7/16" **	PL-7743	PL-7772	PL-7775	PL-7918

* No. 8 Phillips Pan Head Sheet Metal Screws.

** No. 10-24 Phillips Pan Head Machine Screws.

Description: Plastic screen clips in various colors used to attach screen to window opening.

PL-7749 (White)

Flush Clips (Plastic)

Contents: 12 clips with no. 6 x 5/8" Phillips pan head sheet metal screws.

Description: **Double wing** flush clips used to attach screens and storm windows to window opening.

PL-7749

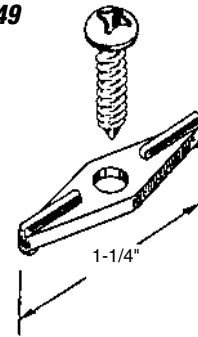

PL-7919 (White)

Flush Clips (Nylon)

Contents: 8 clips with no. 8 x 3/4" Phillips pan head sheet metal screws.

Description: Used to attach screens and storm windows to window opening.

PL-7919

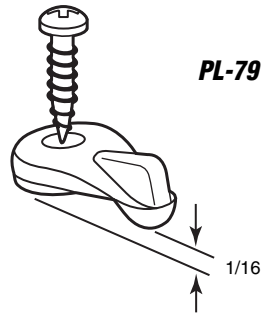

PL-7920 (White)

Turn Buttons (Nylon)

Contents: 12 turn buttons with no. 4 x 3/4" Phillips pan head sheet metal screws.

Description: Turn buttons used to attach screens and storm windows to window opening.

PL-7920

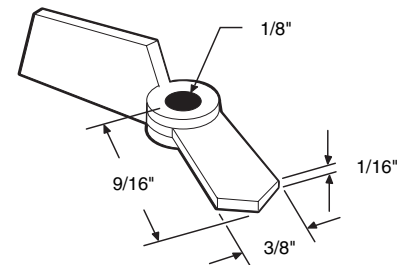

PL-7967

Flush Clips

Contents: 6 clips with no. 8 x 1/2" Phillips pan head sheet metal screws.

Description: **Stamped aluminum, double wing** clips used to attach screens and storm windows to window opening; also applied to narrow rails to hold adjacent screens in place.

PL-7967

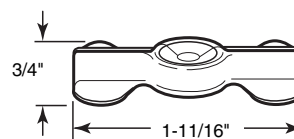

PL-8009

Wing Clips

Contents: 12 clips with no. 8 x 3/4" Phillips pan head sheet metal screws.

Description: **Stamped aluminum** clips used to attach screens and storm windows to window opening.

PL-8009

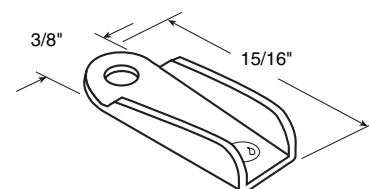

PL-7970

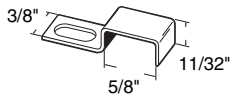

PL-7971

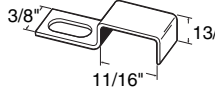

PL-7972

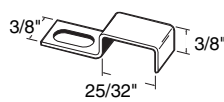

PL-8028

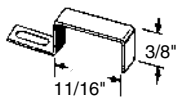

PL-8029

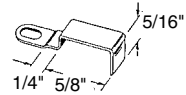

PL-8030

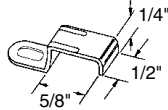

PL-8031

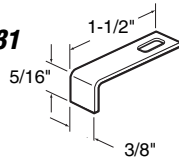

PL-7777

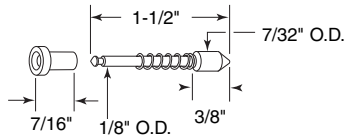

PL-7924

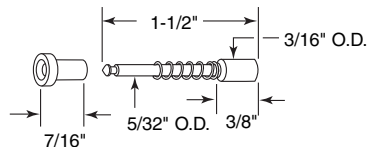

PL-7925

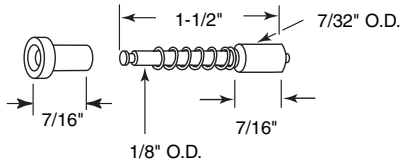

PL-7926

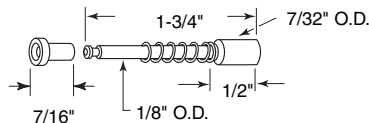

PL-7985

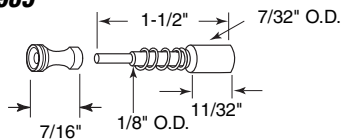

PL-7986

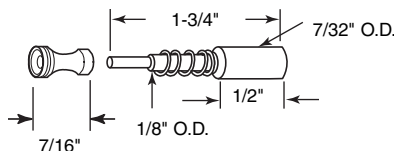

Stretcher Clips

Contents: 12 clips; 12 - #10 x 3/8" Phillips pan head sheet metal screws.

Part #	Frame Application
PL-7970	3/8" x 5/8" flanged frame
PL-7971	5/16" x 3/4" frame
PL-7972	3/8" x 3/4" frame
PL-8028	7/16" x 11/16" frame
PL-8029	For flanged frame
PL-8030	For "Keller" windows - new style
PL-8031	recessed frame

Description: Stamped aluminum clips for attaching window screens to awning and other types of windows.

Plunger Latches

Contents: 6 latch assemblies.

Part #	Plunger	Cap	Screen Frame
PL-7777	Nylon	Nylon	3/8" or 7/16" x 3/4"
PL-7924	Nylon	Nylon	1/4" or 5/16" x 3/4"
PL-7925	Diecast	Nylon	3/8" or 7/16" x 3/4"
PL-7926	Diecast	Nylon	7/16" x 1"
PL-7985	Aluminum	Aluminum	3/8" or 7/16" x 3/4"
PL-7986	Aluminum	Aluminum	7/16" x 1"

Description: Spring loaded plunger latches hold aluminum frame screens into window frames.

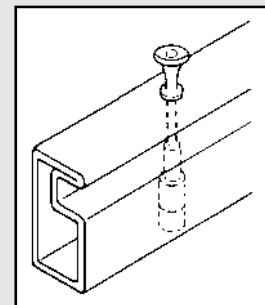

Make - To - Fit

PL-7744 (5/16")
PL-7745 (3/8")
PL-7746 (7/16")
PL-7747 (7/8")
PL-7748 (1-3/16")

Casement Clips (Aluminum)

Contents: 12 clips with no. 10-24 phillips pan head machine screws.

Description: Stamped aluminum casement clips used to secure window screens and storm windows to window or storm door openings.

PL-7750

Retainer Clips (Spring steel)

Contents: 6 clips.

Description: Retainer clips hold 3/8" screen frame to aluminum window channel; **bright finish.**

PL-7751

Retainer Clips (Spring steel)

Contents: 6 clips.

Description: Retainer clips hold 7/16" screen frame to aluminum window channel; **bright finish.**

PL-7752

Retainer Clips (Vinyl)

Contents: 6 clips.

Description: Black vinyl clips are used to hold 3/8" and 7/16" screen frame into aluminum window channel.

PL-7744
PL-7745
PL-7746
PL-7747
PL-7748

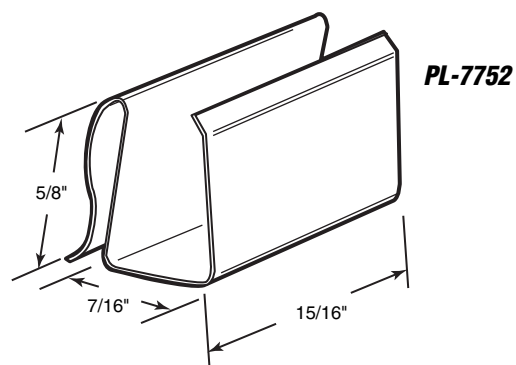
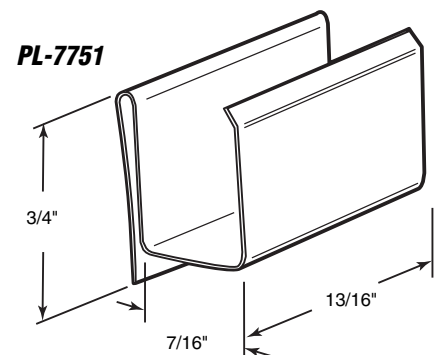
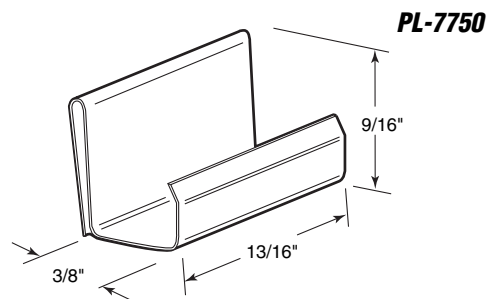
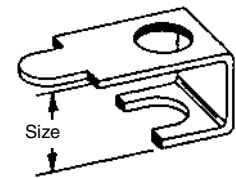

PL-7765

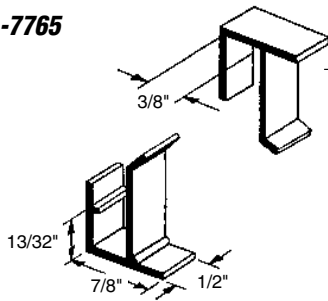

PL-7765 (4 sets / card)

Retainer Clips (Vinyl)

Contents: Sets of top and bottom clips.

Description: Black vinyl clips hold screen frame into sliding window frame channel; used by H&D Industries for 7/16" frame.

Note: very popular in the Northwest.

PL-7753

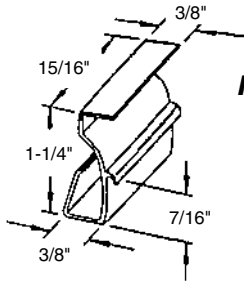

PL-7753

Lift & Retainer Clips (Vinyl)

Contents: 6 clips.

Description: Black vinyl clips used to hold 3/8" screen frame into aluminum window channel; lift tab assists in screen removal.

PL-7754

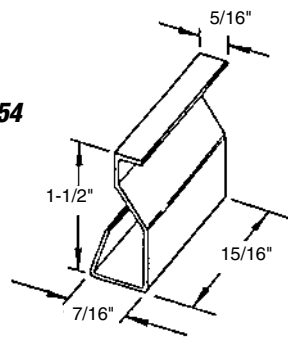

PL-7754

Lift Tabs (Vinyl)

Contents: 6 clips.

Description: Black vinyl lift tab used to aid in removal of 7/16" window screen from window frame.

PL-7755

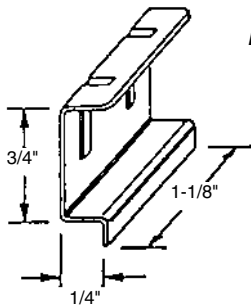

PL-7755

Lift Tabs (Metal)

Contents: 6 clips.

Description: Stamped aluminum lift tab is installed in spline channel to aid in removal of window screen from window frame.

**PL-7756
PL-7921**

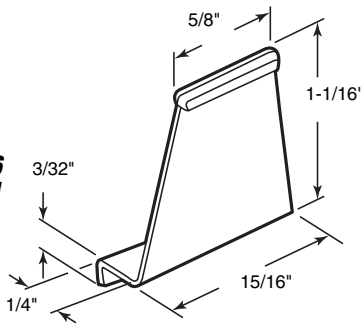

PL-7756 (White)
PL-7921 (Black)

Lift Tabs (Plastic)

Contents: 6 clips.

Description: Plastic lift tab is installed in spline channel to aid in removal of window screen from window frame.

PL-8035

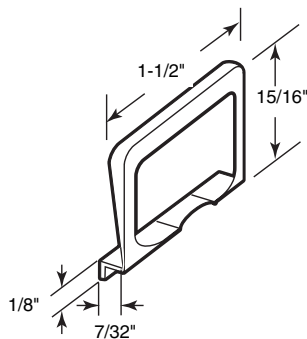

PL-8035 (Black)

Lift Tabs (Plastic)

Contents: 6 clips.

Description: Plastic lift tab may be installed in most sizes of spline channel to aid in removal of window screen from window frame.

PL-7766 (For 3/4" frame)
PL-7927 (For 1" frame)

Lock Pins

Contents: 6 pins.

Description: Plated steel pin used to secure window screens to sliding aluminum windows.

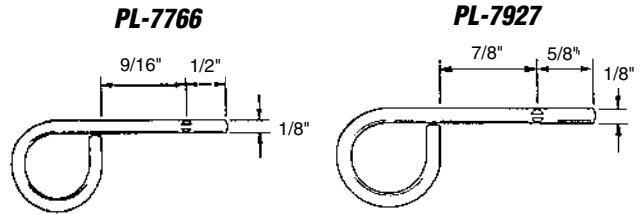

PL-7987 (For 3/4" frame)

Slide Locks

Contents: 6 locks.

Description: Stamped aluminum locks used to attach window screens to aluminum window channel.

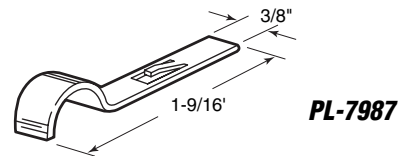

PL-7760 (Mill finish)
PL-7846 (Bronze finish)
PL-7847 (White finish)
PL-7849 (Gray finish)

Hanger and Latches

Contents: 4 top hangers; 2 bottom latches; 2 ball head screws.

Description: Stamped aluminum hardware used to install 7/16" thick window screens to wood framed windows.

See Nail Set Tool P-7921 on page PL-17.

PL-7760
PL-7846
PL-7847
PL-7849

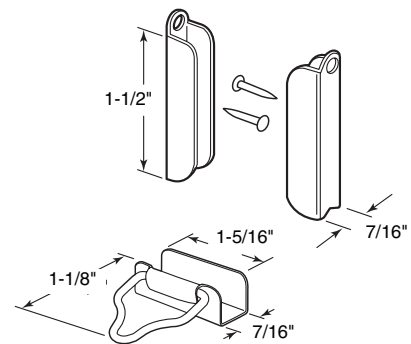

PL-7761 (Mill finish)
PL-7845 (White finish)

Top Hangers

Contents: 6 hangers; 6 nails.

Description: Stamped aluminum hangers nail into top corners of wood window frame; used to hold 7/16" thick frame to window frame.

See Nail Set Tool P-7921 on page PL-17.

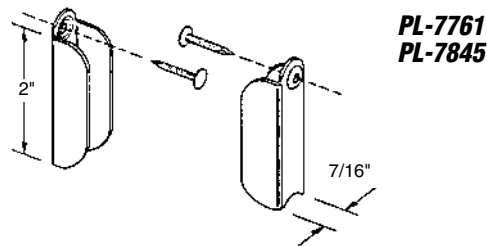

PL-7761
PL-7845

PL-7762 (Mill finish)

Bottom Latches

Contents: 4 latches; 4 ball head screws.

Description: Stamped aluminum latches slip-on to bottom of 7/16" thick frame; used to hold bottom of window screen to wood window sill.

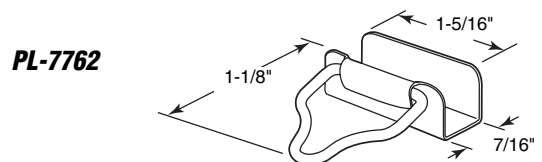

PL-7762

PL-7768 (Mill finish)

Bottom Latches

Contents: 4 latches; 4 ball head screws.

Description: Stamped aluminum latch is installed into spline channel of window screen; used to hold bottom of screen to wood framed window sill.

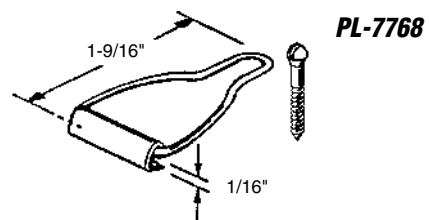

PL-7768

PL-8006

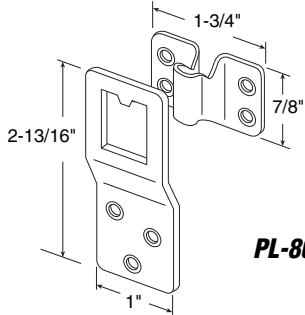
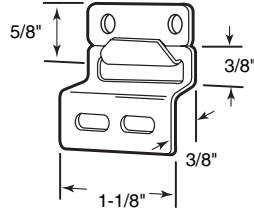

PL-8007

PL-7758

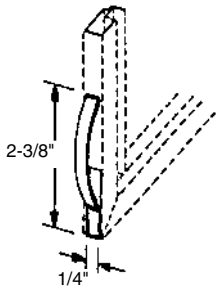
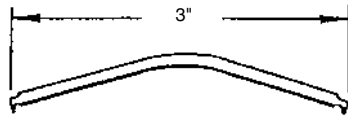

PL-7776

PL-7759

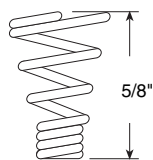
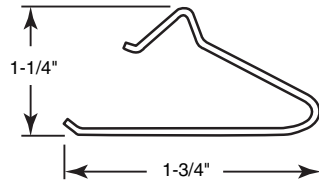

PL-7922

PL-8006

Top Hangers

Contents: 4 hooks; 4 keepers; 4 sets of installation screws.

Description: Stamped aluminum hardware; used on wood framed windows; top mounted; hooks mount to window frame and keepers mount to screen frame.

PL-8007

Top Hangers

Contents: 2 hooks; 2 keepers; 2 sets of installation screws.

Description: Plated steel hardware; used on wood framed windows; top mounted; hooks mount to window frame and keepers mount to screen frame.

PL-7758

Tension Springs

Contents: 6 springs.

Description: Heat treated steel springs hold window screen into sliding aluminum window channels. Requires (2) 3/16" holes drilled 3-3/16" apart.

PL-7776

Tension Springs

Contents: 6 springs.

Description: Heat treated steel tension springs hold window screens into sliding aluminum window screen channels. Slips into corner of 5/16", 3/8" and 7/16" frame. No tools required.

PL-7759

Tension Springs

Contents: 12 springs.

Description: Plated steel spring wire; designed to hold window screens into sliding aluminum window screen channels.

PL-7922

Tension Springs

Contents: 6 springs.

Description: Heat treated steel tension springs hold window screens into sliding aluminum window screen channel. Spring threads into a 1/8" hole.

PL-7968

Storm Panel Clips

Contents: 4 clips.

Description: Heat treated steel designed for holding storm windows or window screen panels in place; snap open or closed.

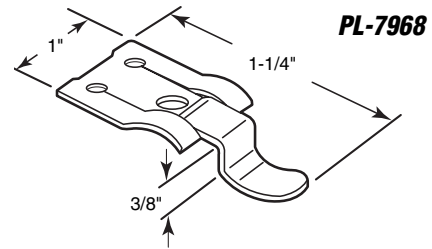

Storm Panel Clips (Extruded Aluminum)

Contents: 8 clips with installation screws.

Mill	White
PL-7939	PL-7940
PL-7941	PL-7942
PL-7947	PL-7948
PL-7949	PL-7950
PL-7951	PL-7952
PL-7953	PL-7954
PL-7955	PL-7956
PL-7957	PL-7958
PL-7959	PL-7960
PL-7961	-
PL-7962	-
PL-7963	-

Description: Extruded aluminum clips attach storm windows or screen panels to storm door frame with thumbscrew.

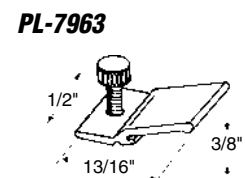
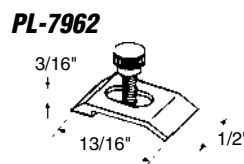
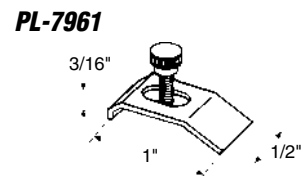
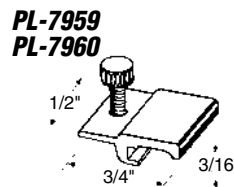
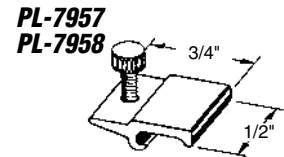
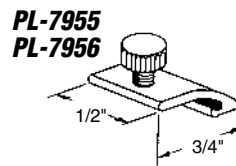
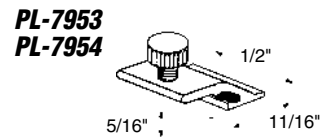
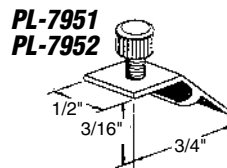
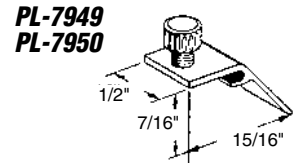
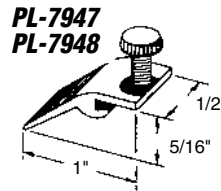
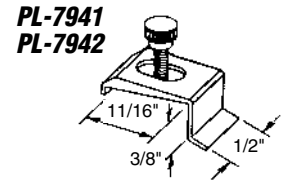
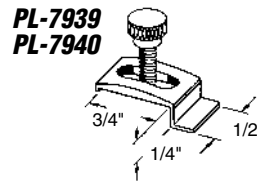
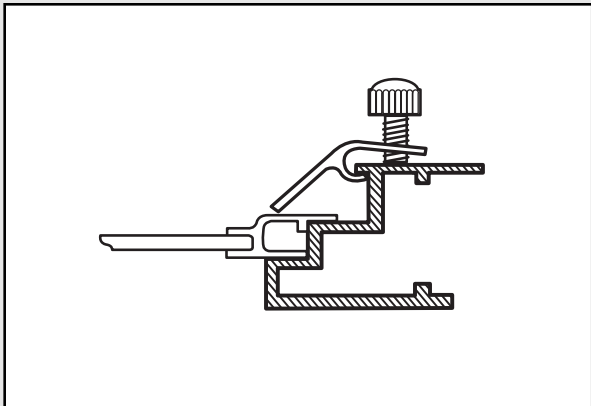

PL-7945
PL-7946

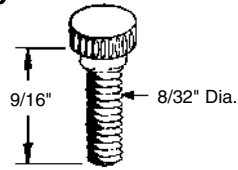

PL-7945 (Mill finish)
PL-7946 (White finish)

Storm Panel Thumbscrews

Contents: (8) no. 8-32 x 9/16" thumbscrews.

Description: Aluminum thumbscrews used with storm door panel clips.

PL-7943
PL-7944

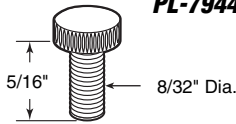

PL-7943 (Mill finish)
PL-7944 (Nylon)

Storm Panel Thumbscrews

Contents: (8) no. 8-32 x 5/16" thumbscrews.

Description: Thumbscrews used with storm panel clips.

PL-7965

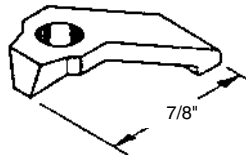

PL-7965

Storm Panel Clips

Contents: 8 clips.

Description: Aluminum turn button; used to attach storm window panels to storm doors.

PL-7964

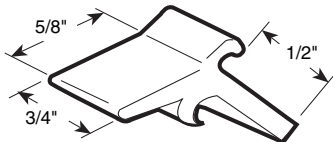

PL-7964 (Nylon)

Storm Panel Clips

Contents: 8 clips.

Description: Self locking storm window panel clips.

Call for Availability

PL-7966

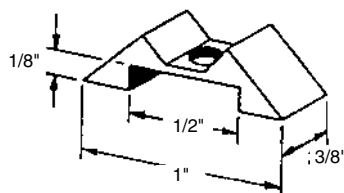

PL-7966

Storm Panel Turn Buttons

Contents: 8 turn buttons.

Description: Aluminum turn button; used to attach storm window panels to storm doors.

Window Grid Retainers

Contents: 6 retainers.

Part #	Fits Grille Bar Width
PL-7976	3/8"
PL-7977	5/8"
PL-7981	7/8"
PL-7978	5/8"
PL-7979	1/2"
PL-7982	1"
PL-7980	7/8"
PL-7983	
PL-7988	
PL-7989	

Description: Clear plastic grid retainer with 1/4" steel pin projection; used to secure decorative window grid in place, some retainers include retainer sleeves.

All grid retainers are available in bulk quantities.

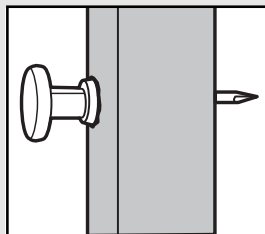
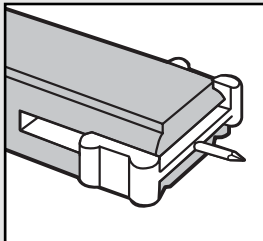
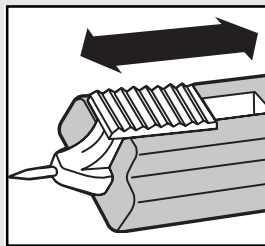
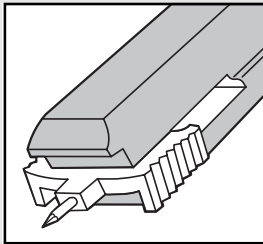

PL-7976

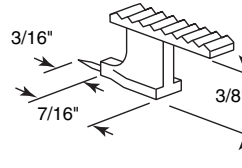

PL-7977

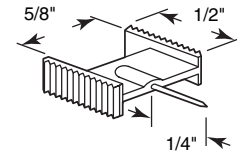

PL-7981

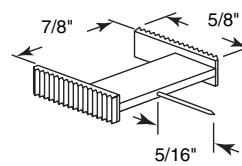

PL-7978

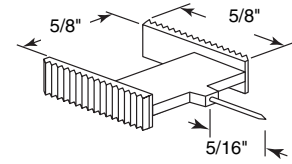

PL-7979

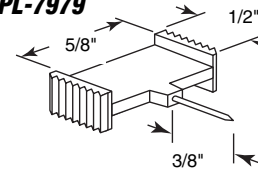

PL-7982

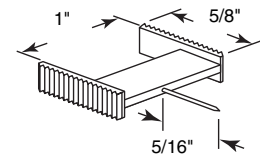

PL-7980

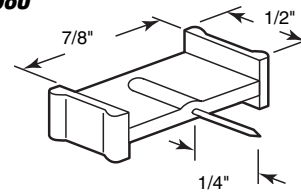

PL-7983

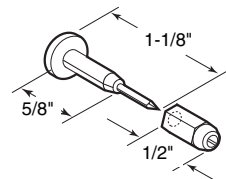

PL-7988

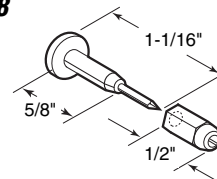

PL-7989

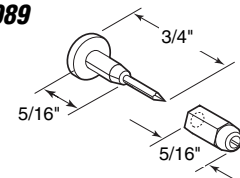

PL-7984

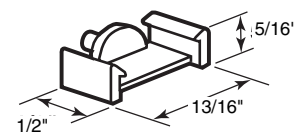

PL-7984

Window Grid Retainer

Contents: 6 retainers.

Description: Clear plastic grid retainer with plastic pin; used to secure decorative window grids in place.

Call for
Availability

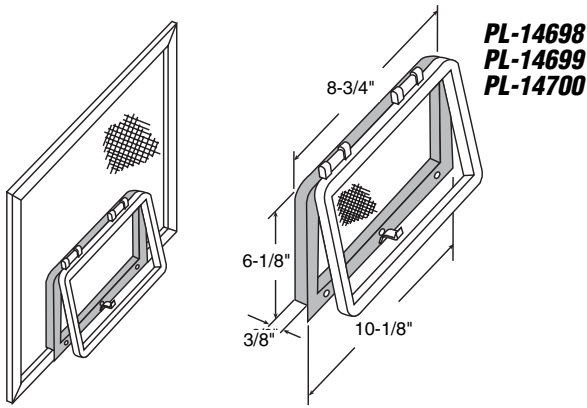

PL-14698 (Gray)
PL-14699 (Bronze)
PL-14700 (White)

PL-14698 (Gray)
PL-14699 (Bronze)
PL-14700 (White)

Plastic Wickets

Contents: 1 wicket; 60" coil of spline; 1 set of installation screws.

Description: Allows access to awning or casement window operators thru an inside window screen; install to existing window screen with minimum width of 12".

PL-15515
PL-15517

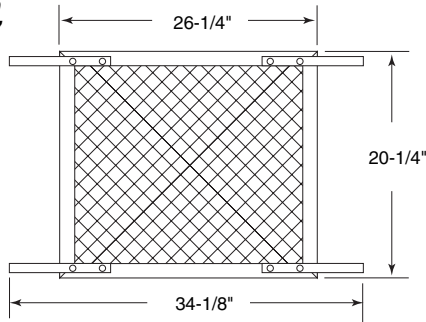

PL-15515 (Gray)
PL-15517 (White)

Plastic Screen/Storm Door Grilles

Contents: 1 grille; 1 set of installation screws.

Description: Molded plastic grille fits most swinging door applications; helps prevent screen or glass damage; easy to install.

P-7921

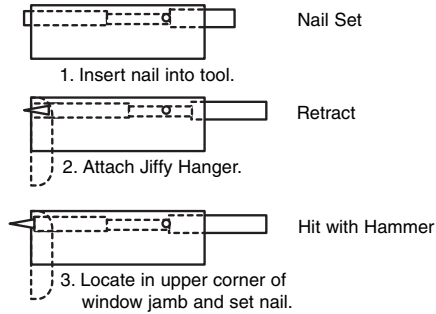
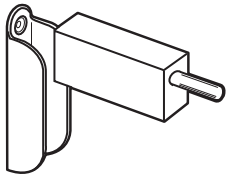

P-7921

Nail Set

Contents: 1 nail set.

Description: Cadmium plated steel; makes installation of top hangers for 7/16" window screen a real snap. Driver retracts to hold nail; nail set housing slips into channel of top hanger; locate hanger to upper corner of wood window frame, then tap driver with hammer to secure hanger.

Note: For installing PL-7760, PL-7761, PL-7845, PL-7846, PL-7847 & PL-7849.

Also Available:

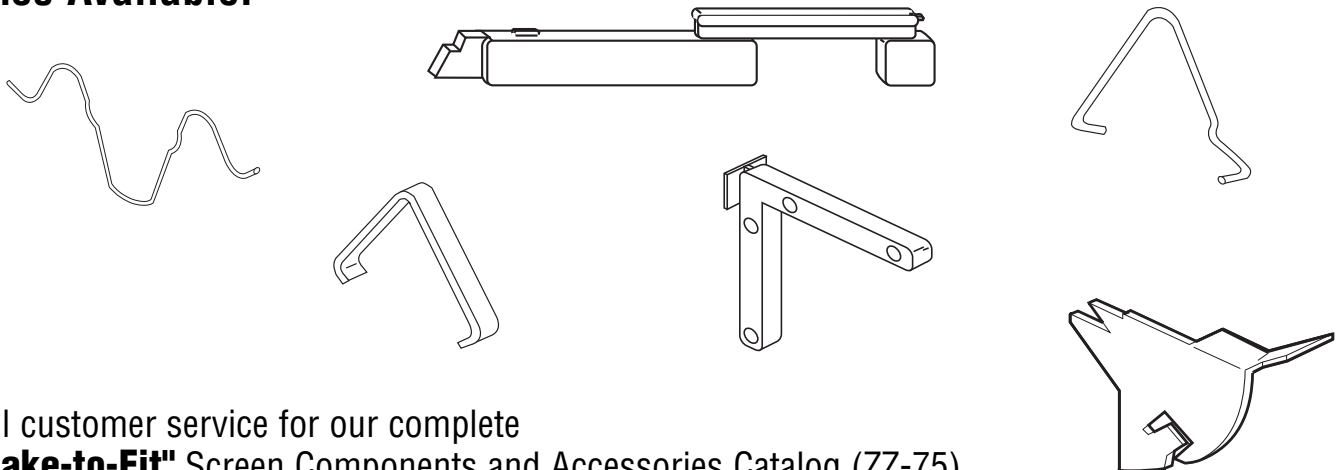

Call customer service for our complete **"Make-to-Fit"** Screen Components and Accessories Catalog (ZZ-75).