

Dispenser box

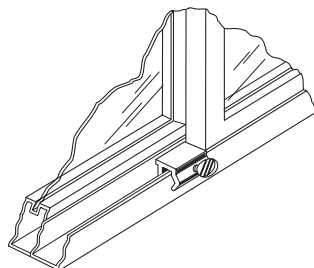

Cut-case merchandiser

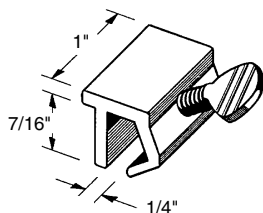
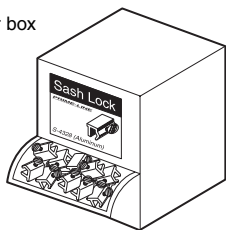
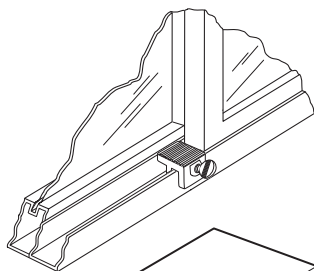
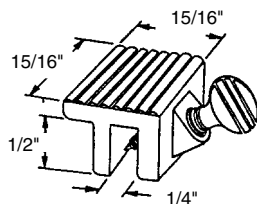
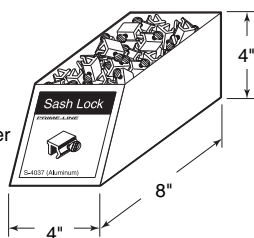

Dispenser box

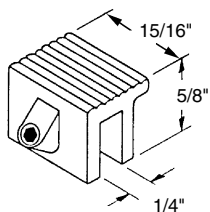
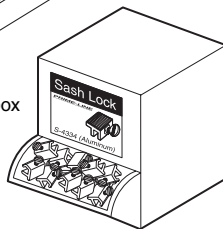

S-4032
S-4033
S-4371

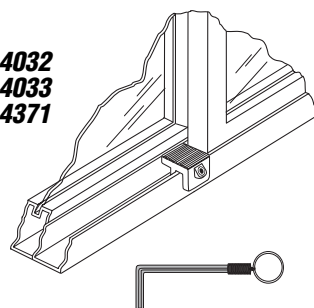

Sash Locks

Finish (Part Number)			Qty.	Qty.
Mill	Black	White	Carded	Dispenser Box
S-4036	S-4076	S-4336	2	—
S-4348	S-4458	S-4457	4	—
S-4328	S-4329	S-4367	—	200/bulk
S-4495	S-4496	S-4497	2/bag	75 bags

Description: Extruded aluminum housing; steel thumbscrew; securely locks window in closed or ventilating position; easy to install.

S-4037 (Aluminum finish)

S-4075 (Black finish)

S-4198 (White finish)

Sash Locks

Contents: 100 locks bulk in a cut-case box.

Description: Extruded aluminum housing; steel thumbscrew; securely locks window in closed or ventilating position; easy to install.

Sash Locks

Finish (Part Number)			Qty.	Qty.
Mill	Black	White	Carded	Dispenser Box
S-4000	S-4001	S-4340	2	—
S-4334	S-4335	S-4470	—	200/bulk
S-4492	S-4493	S-4494	2/bag	75 bags

Description: Heavy duty zinc diecast housing with steel thumbscrew; securely locks window in closed or ventilating position; easy to install.

S-4032 (Aluminum finish)

S-4033 (Black finish)

S-4371 (White finish)

Sash Locks (Tamper-proof)

Contents: 2 locks.

Description: Heavy duty zinc diecast housing with tamperproof Allen head security screw and wrench; securely locks window in closed or ventilating position; prevents accidental opening by children; easy to install.

S-4186 (Aluminum finish)

S-4187 (Black finish)

S-4498 (White finish)

Sash Lock

Contents: 2 locks.

Description: Extruded aluminum housing with tamperproof Allen head security screw and wrench; securely locks window in closed or ventilating position; prevents accidental opening by children; easy to install.

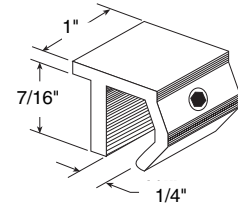
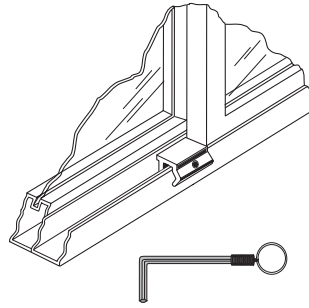

S-4397 (Aluminum finish)

S-4398 (Black finish)

S-4399 (White finish)

No-mar Lock

Contents: 2 locks.

Description: Extruded aluminum with no-mar vinyl insert to protect track flange from scratching; fits wide and narrow type tracks; securely locks window in closed or ventilating position; easy to install.

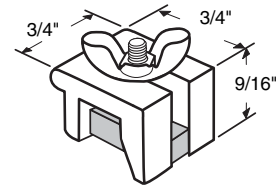
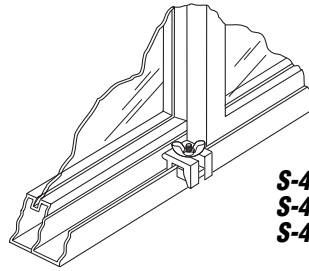

S-4397
S-4398
S-4399

S-4373 (Aluminum finish)

S-4374 (Black finish)

S-4423 (White finish)

Thumbscrew Bar Lock

Contents: 1 lock.

Description: Extruded aluminum; with reversible anti-lift out bar; securely locks window in closed or ventilating position; easy to install.

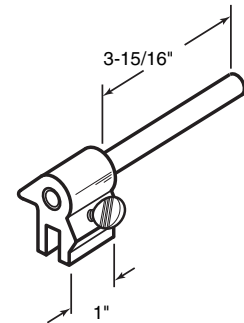
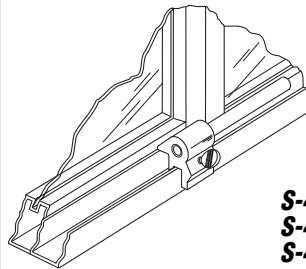

S-4373
S-4374
S-4423

S-4064 (Aluminum finish)

S-4416 (White finish)

Cam Action Lock

Contents: 2 locks.

Description: Extruded aluminum housing with cam action lock; securely locks window in closed or ventilating position; no tools needed to install; excellent added security when staying in a hotel or motel.

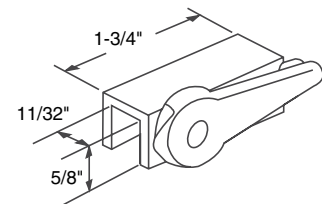
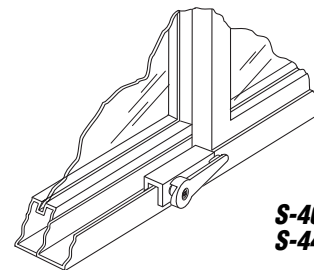

S-4064
S-4416

S-4014 (Aluminum finish)

S-4024 (Black finish)

S-4422 (White finish)

Snap-on Vent Lock

Contents: 2 locks.

Description: Plated and painted steel lock housing; unique "snap-on" device; no tools required; excellent for ventilated locking.

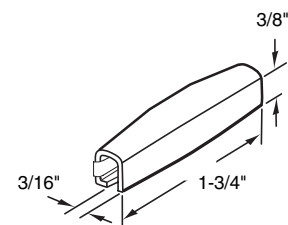
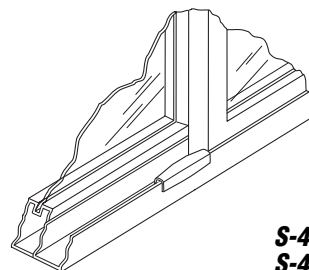

S-4014
S-4024
S-4422

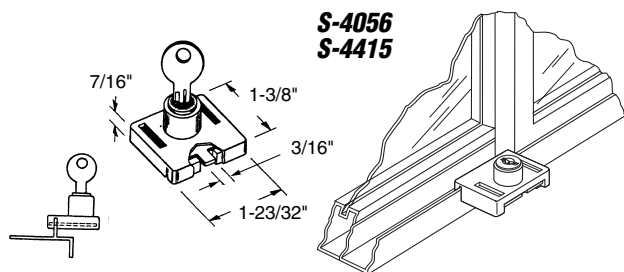

S-4056 (Aluminum finish)
S-4415 (White finish)

S-4056 (Aluminum finish)

S-4415 (White finish)

Keyed Lock

Contents: 1 lock & 2 keys.

Description: Painted diecast housing; securely locks window in closed or ventilating position; easy to install.

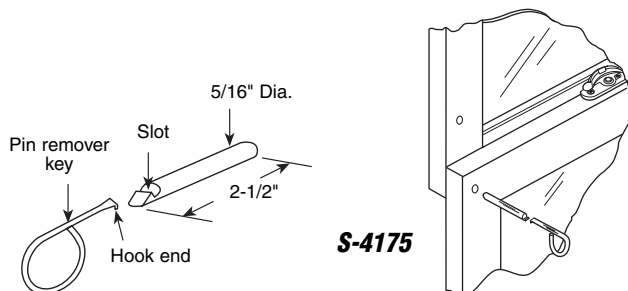

S-4175

S-4175 (Brass finish)

Wood Sash Pins

Contents: 8 pins & 4 keys.

Description: Plated steel pins lock window in closed or ventilating position; pin removal key is needed to unlock; recommended for wood sash; easy to install.

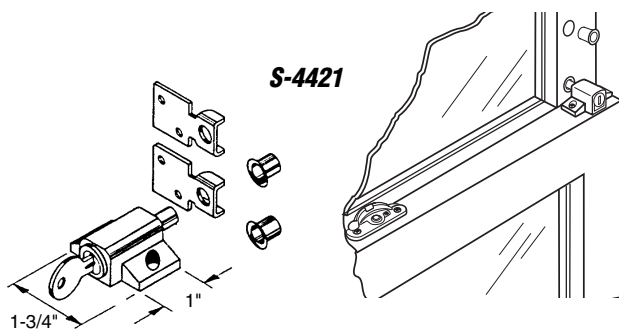

S-4421

S-4421 (Brass finish)

Keyed Sash Lock

Contents: 1 lock with 2 strikes; 2 ferrules; 2 keys & installation screws.

Description: Painted or plated housing; hardened steel bolt provides push button locking in closed or ventilating position; unlocks only with key; heavy duty diecast construction; recommended for wood sash; easy to install.

Note: S-4004 (Aluminum finish)

S-4005 (Black finish)

S-4360 (White finish)

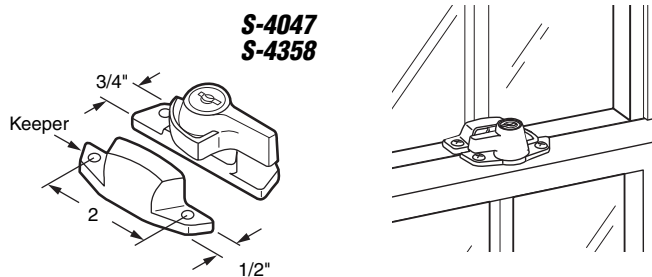

S-4047
S-4358

S-4047 (Brass finish)

S-4358 (White finish)

Keyed Sash Lock

Contents: 1 latch assembly; 1 keeper; 2 keys & installation screws.

Description: Plated or painted diecast sash lock and keeper; for aluminum, vinyl or wood double hung windows; unlocks only with key.

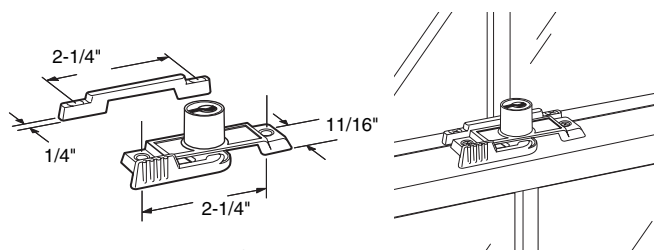

S-4449
S-4359

S-4449 (Brass finish)

S-4359 (White finish)

Slim-line Keyed Sash Lock

Contents: 1 lock and keeper; 2 keys & installation screws.

Description: Plated or painted diecast sash lock and keeper; readily adapts to narrow styles; key locks for additional security.

S-4018 (Brass finish)

Wood Window Flip Lock

Contents: 2 locks & installation fasteners.

Description: Flip lock mounts on vertical track; stops window in vent position; wedge flips out of the way to allow opening; **plated steel** lock assembly.

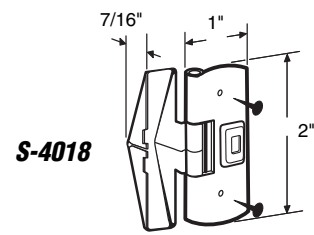
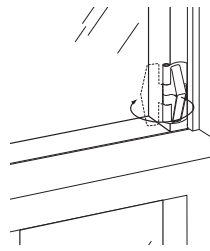

S-4038 (Brass finish)

Wood Window Vent Lock

Contents: 2 lock assemblies; 2 strikeplates & installation screws.

Description: **Brass plated steel** sash locks mount onto the edge of the upper window; sliding stud stops opening at a desired location; allows ventilation but prevents entry; easy to install.

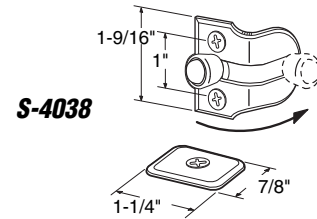
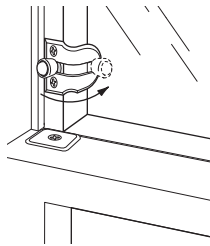

S-4026 (Aluminum finish)

S-4027 (Black finish)

"Push-Bolt" Lock

Contents: 1 lock; 2 installation screws.

Description: Install on bottom or side rail or horizontal or vertical sliding aluminum windows; **stamped steel** housing with **hardened steel bolt**; easy to install.

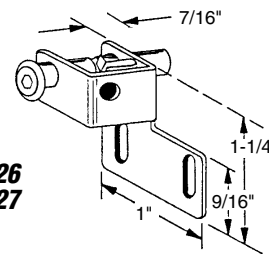

Some items in this section are also available in our new Defender Security Line. This new, distinctively packaged, line is ideally suited for "stand-alone" merchandising



S-4065
S-4403

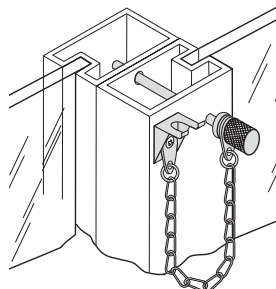
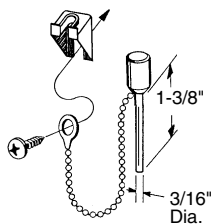

Locked

S-4067
S-4407

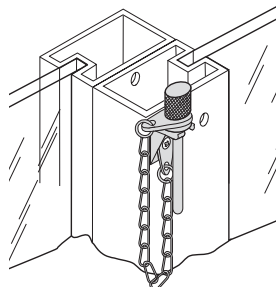
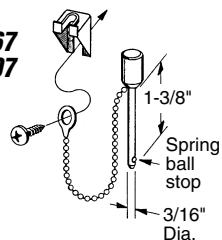

Unlocked

S-4071

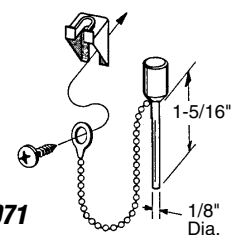

S-4065 (Aluminum finish)

S-4403 (Black finish)

Security Lock Pin

Contents: 1 pin with chain; 1 holder; 1 installation screw.

Description: Case hardened steel pin installs thru moving panel and fixed rail; helps prevent prying or lifting of window; easy to install; fits most windows.

S-4067 (Aluminum finish)

S-4407 (Black finish)

Slip-Proof Lock Pin

Contents: 1 pin with chain; 1 holder; 1 installation screw.

Description: Case hardened steel pin; spring loaded detent ball on end, helps prevent pin from being jarred out of place.

S-4071 (Aluminum finish)

Security Lock Pin

Contents: 1 pin with chain; 1 holder; 1 installation screw.

Description: Case hardened steel pin features a 1/8" pin shaft; will fit casement locking handles and narrow rail windows.

You may wish to stock these related parts: **S-4011**, **S-4065**.

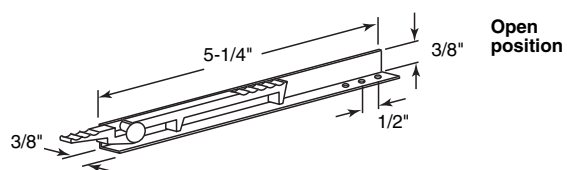

S-4012

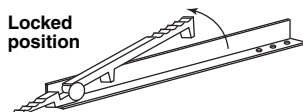

Open position

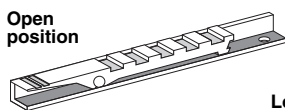

S-4309

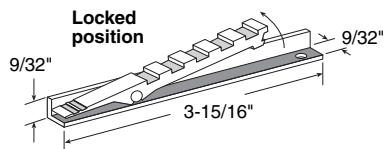

S-4012

"Win-Dor" Pop-Up Lock

Contents: 1 lock; 1 set of installation screws.

Description: Stamped aluminum lock and housing mounts into top or bottom track channel; requires only 3/8" clearance; provides hidden security.

You may wish to stock these related parts: **S-4028**.

S-4309

"Mini" Pop-Up Lock

Contents: 1 lock; 1 set of installation screws.

Description: Extruded aluminum lock and housing mounts into top or bottom channel to provide security.

S-4349 (White)

Latch

Contents: 1 latch; 2 installation screws.

Description: Plastic latch assembly; spring loaded; for horizontal sliding windows.

S-4349

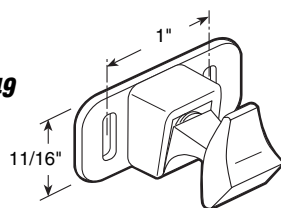

S-4350 (White)

Latch

Contents: 1 latch; 2 installation screws.

Description: Nylon latch assembly; spring loaded; for horizontal sliding windows.

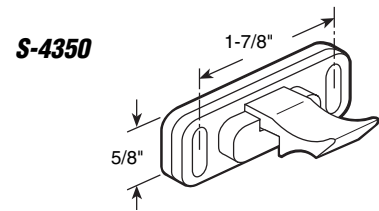

S-4467

Anti-Liftout Blocks (Diecast)

Contents: 2 break-off bars per package with screws.

Description: Prevents liftout of sliding panels when in either the locked or ventilating position; unique stepdown design to provide thickness desired; locate correct size blocks to underside of header and use drill-point screws to install.

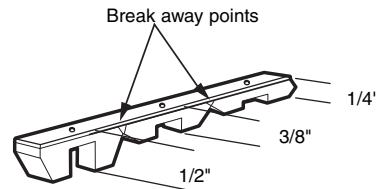

S-4467

S-4070 (4" glass - 3-1/16" long)

S-4072 (4-1/2" glass - 3-7/16" long)

Louver Window Security Clip

Contents: 20 clips.

Description: High tension spring steel clips help prevent removal of glass; no tools required; simply slip under glass as shown; 2 sizes available; fits *International* louvre strip hardware.

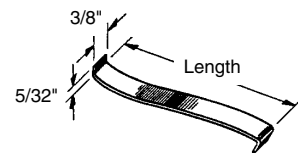
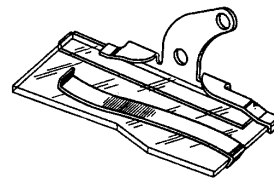

**S-4070
S-4072**

S-4375 (4" glass)

Jalousie Window Security Clip

Contents: 6 clips; 6 keepers.

Description: Durable stainless steel two-piece clips prevent removal of glass louvers from outside, and discourage forced entry; easy installation; ideal for coastal areas.

NEW: Stainless Steel Clip

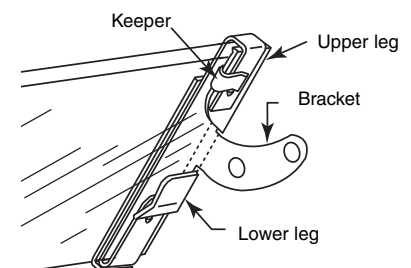
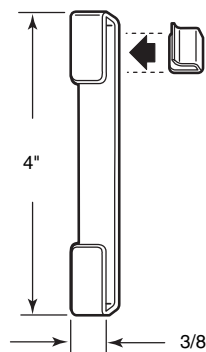

S-4375

**See Our Selection
of Sliding Window Rollers**

