

Sash Lift

Contents: 2 lifts; installation screws.

Description: Stamped steel sash lift handle; popular on older wood double hung windows.

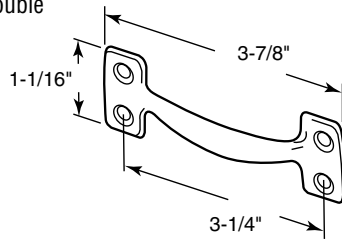

- F-2817** (Brass)
- F-2818** (Chrome)

Sash Lift

Contents: 2 lifts; installation screws.

Description: Stamped steel sash lift; popular on older wood double hung windows.

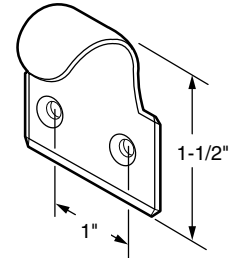

- F-2539** (Brass)
- F-2540** (Chrome)

Sash Lift

Contents: 1 lift; installation screws.

Description: Mortise style sash lift; used on vinyl and aluminum double hung windows; molded plastic.

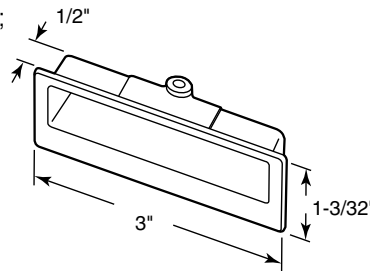

- F-2805** (Black)
- F-2806** (Brown)

Sash Lock

Contents: 1 lock; 1 keeper; installation screws.

Description: Diecast sash lock and keeper; cam action latch draws sashes tight for a good seal when locked; 3/8" mounting screw backset.

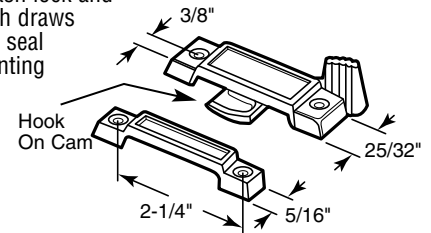

- F-2648** (Brass)
- F-2531** (Chrome)
- F-2532** (Black)
- F-2533** (White)

Sash Lock

Contents: 1 lock; 1 keeper; installation screws.

Description: Composite, space-age polymer sash lock and keeper; 50% stronger than zinc; will not corrode; cam action latch draws sashes tight for a good seal when locked; 3/8" mounting screw backset.

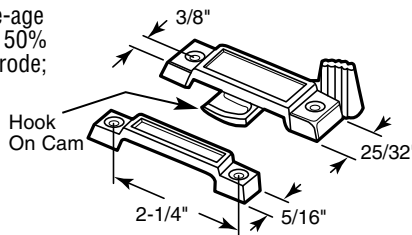

- F-2672** (Black)
- F-2673** (White)

Keyed Sash Lock

Contents: 1 lock; 1 keeper; 2 keys; installation screws.

Description: Diecast sash lock and keeper; 3/8" mounting screw backset.

AVAILABLE KEYED ALIKE.

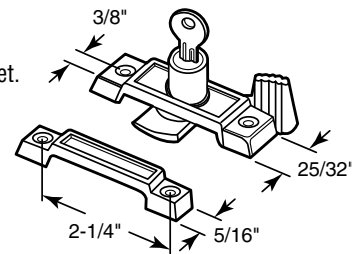

- F-2819** (Brass)
- F-2723** (Chrome)
- F-2583** (Black)
- F-2820** (White)

Sash Lock

Contents: 1 lock; installation screws.

Description: Composite, space-age polymer sash lock; 50% stronger than zinc; will not corrode; this lock does not use a keeper; latch tongue engages fixed rail of opposing sash; 3/8" mounting screw backset.

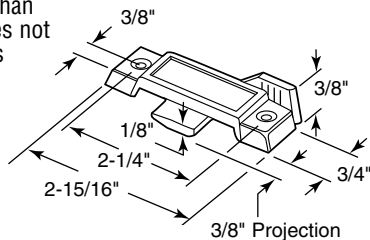

- F-2665** (Black)
- F-2666** (White)

Sash Lock

Contents: 1 lock; installation screws.

Description: Diecast sash lock; this lock does not use a keeper; latch tongue engages fixed rail of opposing sash; 3/8" mounting screw backset.

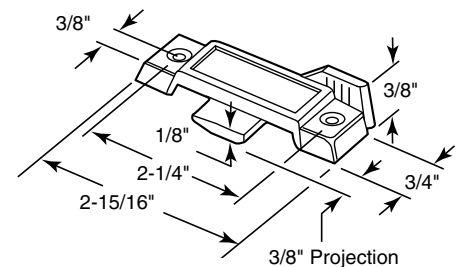

- F-2659** (Gray - 3/8" latch projection)
- F-2589** (Black - 3/8" latch projection)
- F-2596** (Bronze - 3/8" latch projection)
- F-2590** (White - 3/8" latch projection)
- F-2592** (White - 1/2" latch projection)
- F-2591** (Black - 5/8" latch projection)
- F-2783** (Almond - 5/8" latch projection)

Sash Lock

Contents: 1 lock; installation screws.

Description: Diecast sash lock; this lock does not use a keeper; latch tongue engages fixed rail of opposing sash; 5/8" mounting screw backset; fits on *International Windows*® and others.

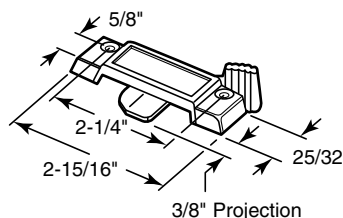

- F-2782** (Black)
- F-2780** (White)
- F-2781** (Almond)

Sash Lock

Contents: 1 lock; installation screws.

Description: Fiber re-inforced plastic sash lock; this lock does not use a keeper; latch tongue engages fixed rail of opposing sash; 3/8" mounting screw backset.

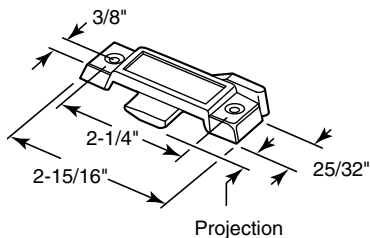

- F-2797** (Black - 3/8" latch projection)
- F-2798** (Black - 1/2" latch projection)
- F-2795** (White - 3/8" latch projection)
- F-2796** (White - 1/2" latch projection)
- F-2799** (Almond - 3/8" latch projection)
- F-2800** (Almond - 1/2" latch projection)

Sash Lock

Contents: 1 lock; installation screws.

Description: White diecast sash lock; this lock does not use a keeper; latch tongue engages fixed rail of opposing sash; 1/2" mounting screw backset; fits on *MI Windows*®.

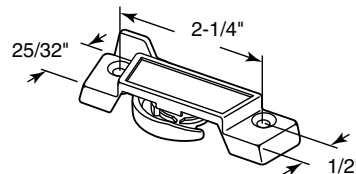

F-2758

Sash Lock

Contents: 1 lock; installation screws.

Description: White diecast sash lock; this lock does not use a keeper; latch tongue engages fixed rail of opposing sash; 1/2" mounting screw backset; fits on *International Windows*®.

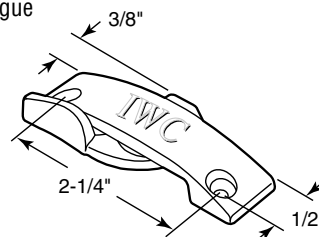

F-2779

Sash Lock (Right Hand)

Contents: 1 lock; installation screws.

Description: Diecast sash lock; this lock does not use a keeper; latch tongue engages fixed rail of opposing sash; includes channel locking bar; 1/2" mounting screw backset; fits *Guaranteed Products*® windows.

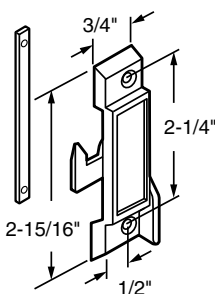
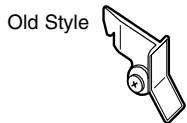

- F-2512** (Black)
- F-2594** (White)

Sash Lock (Left Hand)

Contents: 1 lock; installation screws.

Description: Diecast sash lock; this lock does not use a keeper; latch tongue engages fixed rail of opposing sash; 9/16" mounting screw backset; fits *Guaranteed Products*® windows.

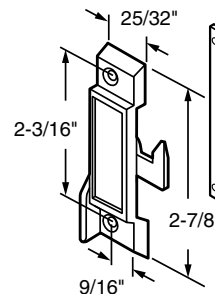

F-2658 (Black)

Sash Lock

Contents: 1 lock; installation screws.

Description: Diecast sash lock; this lock does not use a keeper; latch tongue engages fixed rail of opposing sash; 3/8" mounting screw backset.

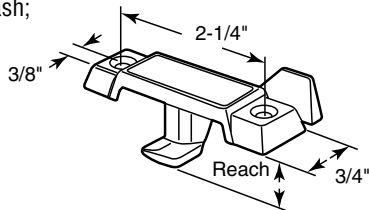

- F-2595** (Black - 9/32")
- F-2771** (Black - 1/2")
- F-2689** (White - 9/32")
- F-2756** (White - 1/2")
- F-2688** (Brown - 9/32")

Sash Lock

Contents: 1 lock; installation screws.

Description: White diecast sash lock; this lock does not use a keeper; latch tongue engages fixed rail of opposing sash; fits *International*® windows.

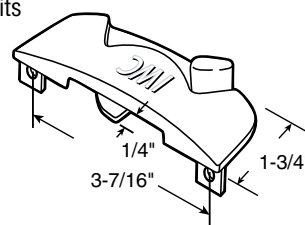

F-2704

Pull & Lock

Contents: 1 pull with spring.

Description: Diecast sash lock with secondary night lock feature; latch locks into opposing sash; fits *Superior*® windows.

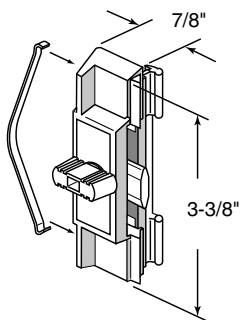

- F-2649** (Black)
- F-2650** (White)

Sash Lock

Contents: 1 lock; 1 keeper; installation screws.

Description: White diecast sash lock and keeper; cam action latch draws the sashes tight for a good seal when locked; latch body has alignment lugs; 3/8" mounting screw backset.

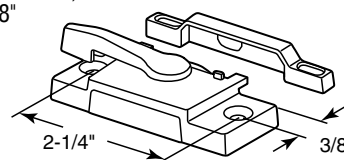

F-2744

Sash Lock

Contents: 1 lock; 1 keeper; installation screws.

Description: Black heavy duty diecast latch assembly and keeper; cam action lock holds window securely closed; flush mount strike requires a 1-1/2" x 3/8" x 1/4" deep recess; 3/8" mounting screw backset.

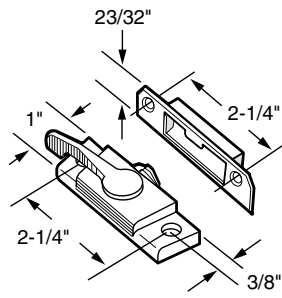

F-2654

Sash Lock

Contents: 1 lock; 1 keeper; installation screws.

Description: White diecast sash lock and keeper; cam action latch draws the sashes tight for a good seal when locked; 7/16" mounting screw backset.

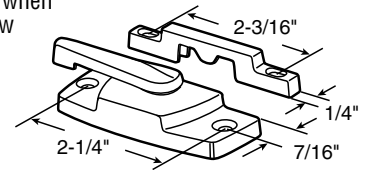

F-2768

Sash Lock

Contents: 1 lock; 1 keeper; installation screws.

Description: White composite space-age polymer sash lock and keeper; 50% stronger than zinc; will not corrode; cam action latch draws the sashes tight for a good seal when locked; 7/16" mounting screw backset.

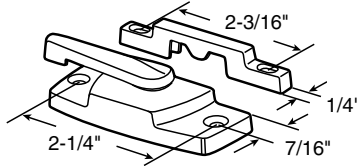

F-2667

Sash Lock

Contents: 1 lock; 1 keeper; installation screws.

Description: Diecast sash lock and keeper; cam action latch draws the sashes tight for a good seal when locked; latch body has alignment lugs; latch body has an 7/16" back set of the mounting holes.

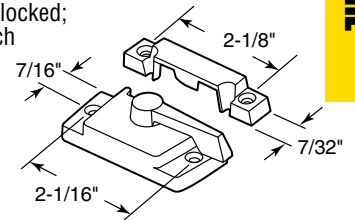

TH-23084 (Bronze)
TH-23085 (White)

Sash Lock

Contents: 1 lock; 1 keeper; installation screws.

Description: White diecast sash lock and keeper; cam action latch draws the sashes tight for a good seal when locked; latch body has alignment lugs; latch body has an 7/16" back set of the mounting holes.

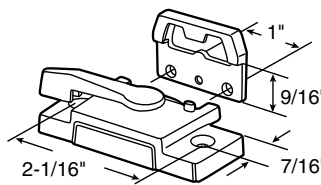

F-2755

Sash Lock

Contents: 1 lock; 1 keeper; installation screws.

Description: White diecast sash lock and keeper; cam action latch draws the sashes tight for a good seal when locked; latch body has alignment lugs; latch body has an 7/16" back set of the mounting holes.

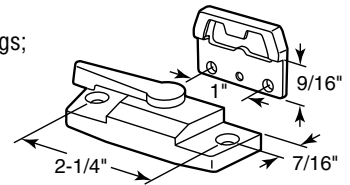

F-2767

Sash Lock

Contents: 1 lock; 1 keeper; installation screws.

Description: Diecast sash lock and keeper; cam action latch draws the sashes tight for a good seal when locked; latch body has an 11/16" back set of the mounting holes; fits **Comfort Line**® windows.

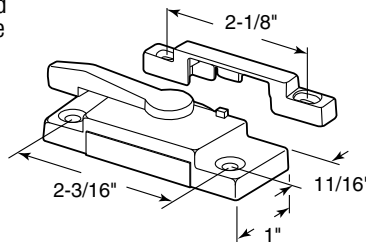

F-2784 (White)
F-2785 (Almond)

Sash Lock

Contents: 1 lock; 1 keeper; installation screws.

Description: Diecast sash lock and keeper; cam action latch draws the sashes tight for a good seal when locked; latch body has alignment lugs; latch body has an 11/16" back set of the mounting holes.

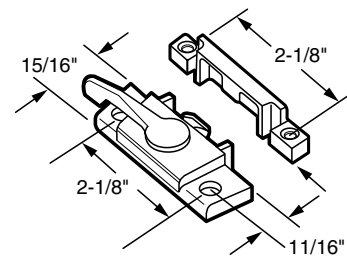

F-2632 (Brass)
F-2554 (White)

Sash Lock

Contents: 1 lock; 1 keeper; installation screws.

Description: Diecast sash lock and keeper; cam action latch draws the sashes tight for a good seal when locked; latch body has alignment lugs; latch body has an 11/16" back set of the mounting holes.

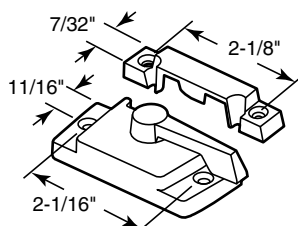

TH-23086 (Bronze)
TH-23087 (White)

Sash Lock

Contents: 1 lock; 1 keeper; installation screws.

Description: Diecast sash lock and keeper; cam action latch draws the sashes tight for a good seal when locked; latch body has an 11/16" back set of the mounting holes.

F-2746 shown

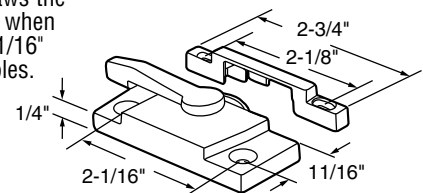

F-2746 (White)
F-2747 (No keeper - Almond)

Sash Lock

Contents: 1 lock; 1 keeper; installation screws.

Description: Diecast sash lock and keeper; cam action latch draws the sashes tight for a good seal when locked; latch body has an 11/16" back set of the mounting holes.

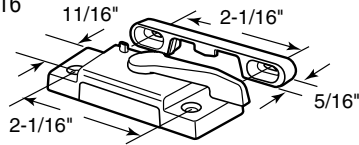

F-2625 (Left hand)
F-2626 (Right hand)

Left Hand Shown in Locked Position

Keyed Sash Lock

Contents: 1 lock; 1 keeper; 2 keys; installation screws.

Description: White button lock; diecast sash lock and keeper; this latch can only be opened with a key; latch body has alignment lugs; latch body has an 11/16" back set of the mounting holes.

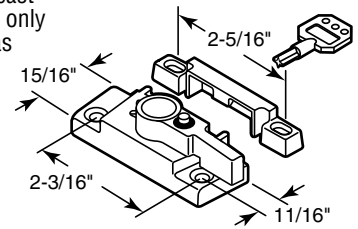

F-2624

Sash Lock

Contents: 1 lock; 1 keeper; installation screws.

Description: White diecast sash lock and keeper; cam action latch draws the sashes tight for a good seal when locked; latch body has alignment lugs; latch body has an 23/32" back set of the mounting holes.

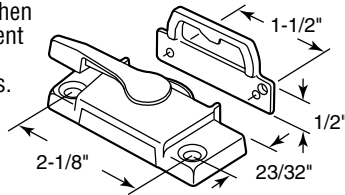

Call For Availability

F-2778

Sash Lock

Contents: 1 lock; 1 keeper; installation screws.

Description: White diecast sash lock and keeper; cam action latch draws the sashes tight for a good seal when locked; keeper nests inside housing; latch body has an 5/8" back set of the mounting holes; housing mortised 5/32" into sash.

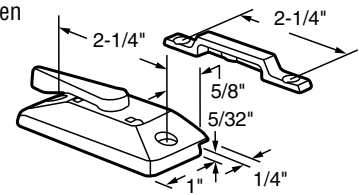

F-2741

Sash Lock

Contents: 1 lock; 1 keeper; installation screws.

Description: Diecast sash lock and keeper; cam action latch draws the sashes tight for a good seal when locked; latch body has a 7/16" back set of the mounting holes.

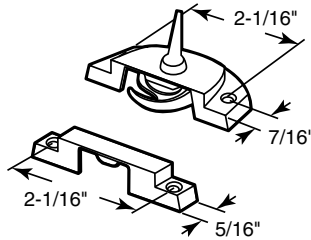

F-2762 (Silver)
F-2763 (Bronze)
F-2588 (White)

Sash Lock

Contents: 1 lock; 1 keeper; installation screws.

Description: Composite, space-age polymer sash lock and keeper; 50% stronger than zinc; will not corrode; cam action latch draws the sashes tight for a good seal when locked; latch body has a 7/16" back set of the mounting holes.

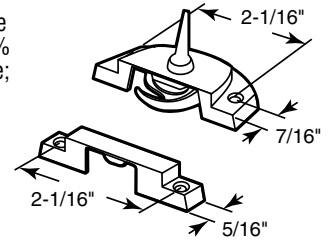

F-2669 (White)

Sash Lock

Contents: 1 lock; 1 keeper; installation screws.

Description: White diecast sash lock and keeper; cam action latch draws the sashes tight for a good seal when locked; latch body has a 7/16" back set of the mounting holes.

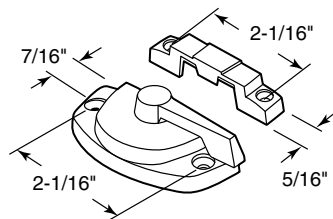

TH-23082

Sash Lock

Contents: 1 lock; 1 keeper; installation screws.

Description: Diecast sash lock and keeper; cam action latch draws the sashes tight for a good seal when locked; latch body has alignment lugs; latch body has a 7/16" back set of the mounting holes.

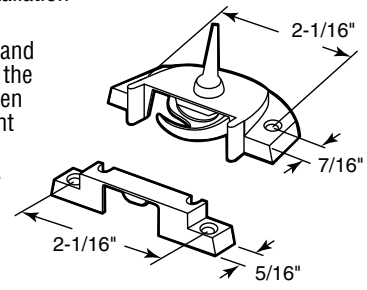

F-2633 (Brass)
F-2687 (White)

Sash Lock

Contents: 1 lock; 1 keeper; installation screws.

Description: Diecast sash lock and keeper; cam action latch draws the sashes tight for a good seal when locked; latch body has alignment lugs; latch body has a 7/16" back set of the mounting holes.

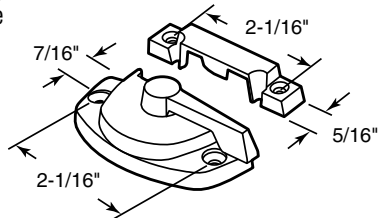

TH-23080 (Bronze)
TH-23081 (White)

Sash Lock

Contents: 1 lock; 1 keeper; installation screws.

Description: White diecast sash lock and keeper; cam action latch draws the sashes tight for a good seal when locked; latch body has alignment lugs; latch body has a 11/16" back set of the mounting holes.

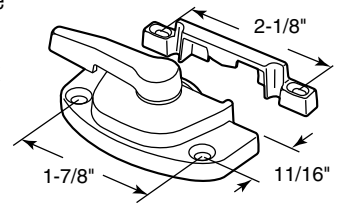

F-2754

Sash Lock

Contents: 1 lock; 1 keeper; installation screws.

Description: Diecast sash lock used on wood windows, designed to be mortised into sash rail; housing mortised 11/32" into sash.



Left Hand Shown

- F-2684** (Bronze - left hand)
- F-2681** (Bronze - right hand)
- F-2683** (White - left hand)
- F-2680** (White - right hand)
- F-2685** (Coppertone - left hand)
- F-2682** (Coppertone - right hand)

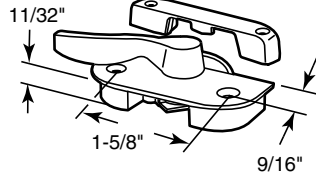

Sash Lock

Contents: 1 lock; installation screws.

Description: Black diecast sash lock; used on vinyl style windows; 3 hole mount design.

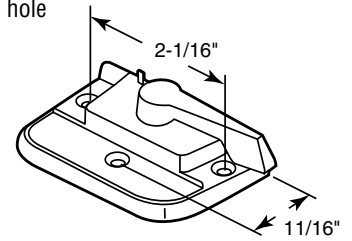

F-2807

Keeper

Contents: 2 keepers; installation screws.

Description: White; face mount keeper; diecast construction; powder coated finish.

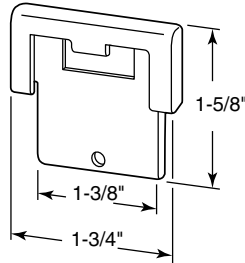

F-2792

Keeper

Contents: 2 keepers; installation screws.

Description: White diecast face mount keeper for cam style sash locks.

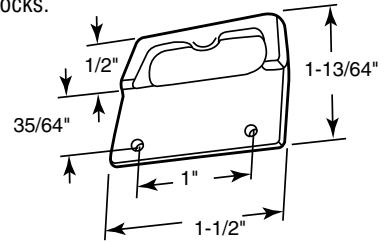

F-2738

Keeper

Contents: 2 keepers; installation screws.

Description: White diecast face mount keeper for cam style sash locks.

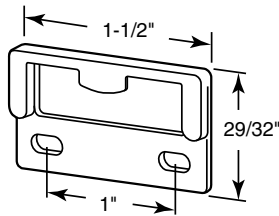

F-2791

Keeper

Contents: 2 keepers; installation screws.

Description: White face mounted keeper, heavy zinc casting; designed to mortise into vinyl double hung windows.

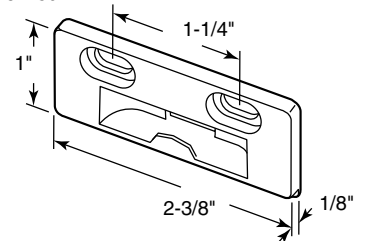

F-2786

Keeper

Contents: 2 keepers; installation screws.

Description: White diecast face mount keeper for cam style sash locks; works with locks with alignment lugs like F-2755.

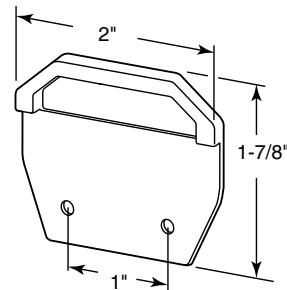

Call For Availability

- F-2789** (White)
- F-2790** (Almond)

Self Locking Latch & Keeper

Contents: 1 lock; 1 keeper; installation screws.

Description: White diecast sash lock and keeper; hidden mounting holes are 1-7/16" apart; latch will slam shut; used on vinyl windows.

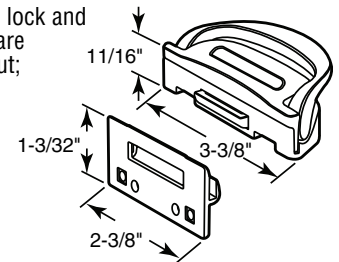

F-2740

Self Locking Latch & Keeper

Contents: 1 lock; 1 keeper; installation screws.

Description: White diecast sash lock and keeper; latch has a single mounting hole; latch will slam shut; used on vinyl windows.

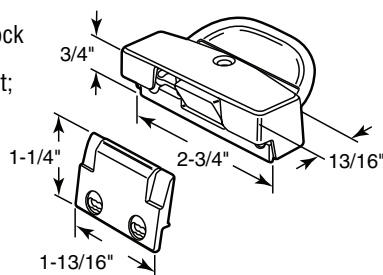

F-2731

Sash Lock

Contents: 1 lock; installation screws.

Description: White diecast sash lock; this lock does not use a keeper; latch tongue engages fixed rail of opposing sash; latch will slam shut; fits *International*® windows.

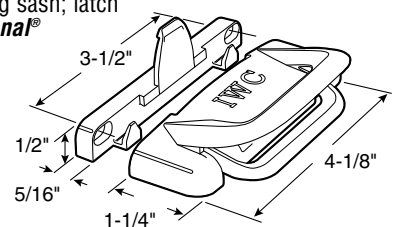

F-2686

Latch and Pull

Contents: 1 latch; installation screws.

Description: Black diecast sash lock; spring loaded; latches into fixed rail of opposing sash; latch will slam shut; retracts 1/8"; 13/32" mounting screw backset; used by several window manufacturers.

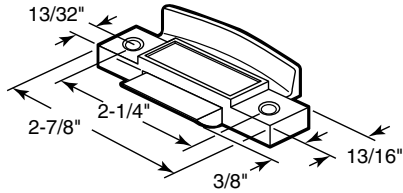

F-2607

Latch and Pull

Contents: 1 latch.

Description: Diecast sash lock; spring loaded; latches into fixed rail of opposing sash; fits **Crossly**® windows.

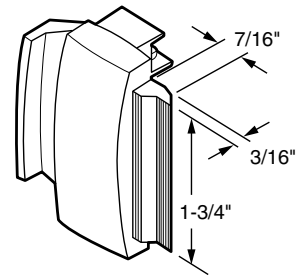

Call For Availability

F-2529 (Gray)

F-2530 (Bronze)

Latch and Pull

Contents: 1 latch, 1 strike; installation screws.

Description: Diecast base with spring loaded extruded aluminum latch; fits **International**® windows.

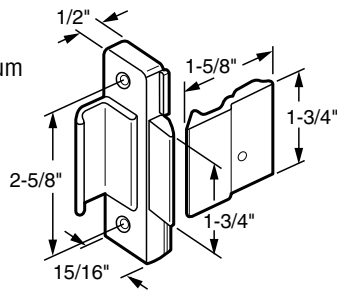

F-2517 (Aluminum)

F-2661 (Bronze)

Latch and Pull

Contents: 1 latch; installation screws.

Description: Black diecast sash lock; spring loaded; latches into fixed rail of opposing sash; fits **Window Master**® Series 216 windows.

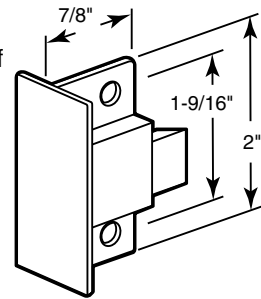

F-2611

Latch and Pull

Contents: 1 latch; installation screws.

Description: Brite zinc diecast sash lock; spring loaded; latches into fixed rail of opposing sash; used by several window manufacturers.

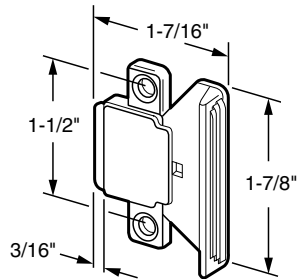

F-2507

Latch

Contents: 1 latch; installation screws.

Description: Black oxide finish; heavy-duty steel design; originally fits on **Guaranteed Products**®; spring-loaded latch projects 1/4" from edge of housing.

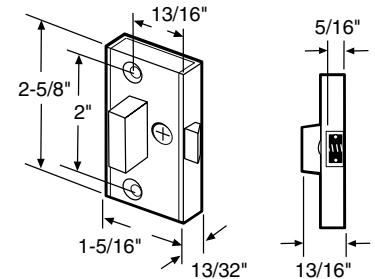

F-2597

Call For Availability

Latch and Pull

Contents: 1 pull with 2 springs; installation screws.

Description: White plastic sash lock; spring loaded; latches into fixed rail of opposing sash; used by several window manufacturers.

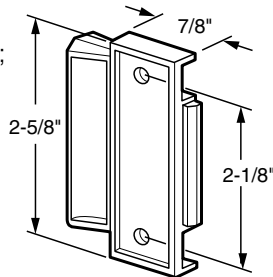

F-2505

Latch and Pull

Contents: 1 pull with spring; installation screws.

Description: Black plastic sash lock; spring loaded; latches into fixed rail of opposing sash; used by several window manufacturers.

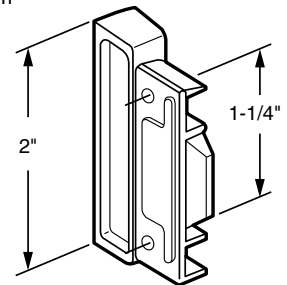

F-2518

Latch and Pull

Contents: 1 pull; installation screws.

Description: Black plastic sash lock; spring loaded; latches into fixed rail of opposing sash; fits **Rolleze**® windows.

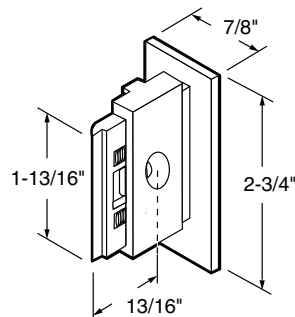

F-2553

Latch and Pull

Contents: 1 latch; installation screws.

Description: Black plastic spring-loaded latch; fits on **Rolleze**® windows.

Note: F-2553 replaces this part.

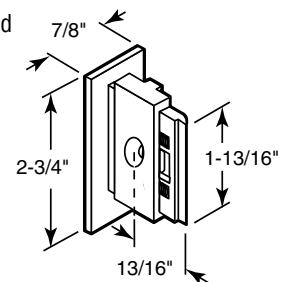

F-2506

Call For Availability

Latch

Contents: 2 latches; 2 keepers; installation screws.

Description: Diecast sash lock and keeper; brite zinc finish; used on both residential and RV sliding windows.

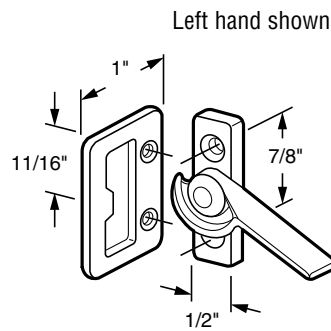

- F-2510** (Left hand)
- F-2511** (Right hand)
- F-2613** (1 Right hand, 1 left hand)

Sash Lock

Contents: 2 locks; installation screws.

Description: Nickel plated diecast sash lock; used on vertical hung windows by several manufacturers.

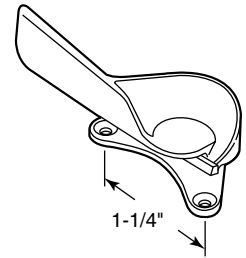

F-2652

Sash Lock

Contents: 1 lock; 1 keeper; installation screws.

Description: Diecast sash lock and keeper; brite zinc finish; fits on *Season-All*® wood windows.

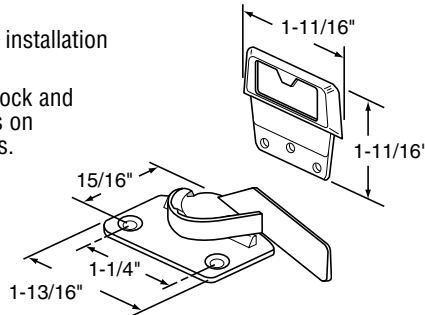

F-2609

Sash Lock

Contents: 2 locks; 2 keepers; installation screws.

Description: Diecast sash lock with stamped steel keeper; brite zinc finish; fits *Daryl*® windows.

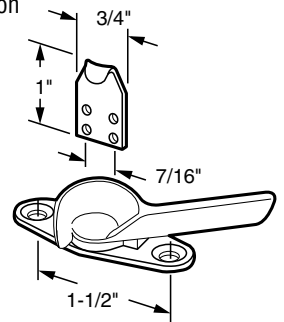

F-2509

Sash Lock

Contents: 2 locks; installation screws.

Description: Diecast sash lock; brite zinc finish; fits on single hung windows by *Keller*®.

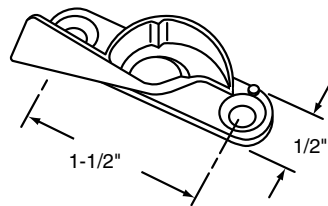

F-2644

Sash Lock

Contents: 2 locks; installation screws.

Description: Diecast sash lock; fits on windows by *Keller*®.

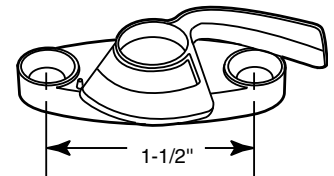

- F-2691** (Zinc)
- F-2674** (Gray)
- F-2690** (Brown)

Sash Lock

Contents: 1 lock; 1 keeper; installation screws.

Description: Diecast sash lock and keeper; brite zinc finish; used by several window manufacturers.

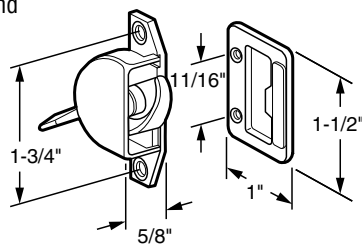

F-2508

Sash Lock

Contents: 2 locks; installation screws.

Description: Black diecast sash lock; fits *Croft*® windows.

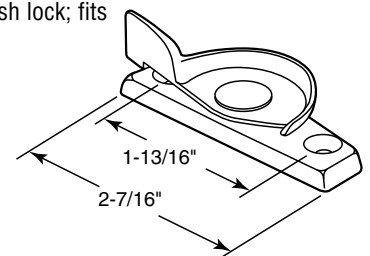

F-2593

Latch

Contents: 2 locks; 2 bushings; installation screws.

Description: Sash lock for both horizontal and vertical sliding windows; for camper shell and RV type windows.

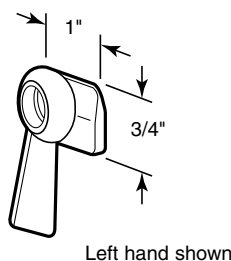

- F-2585** (Black plastic - Left hand)
- F-2586** (Black plastic - right hand)
- F-2570** (Diecast chrome - Left hand)
- F-2571** (Diecast chrome - right hand)
- F-2612** (Diecast chrome - 1 right hand & 1 left hand)

Latch and Pull

Contents: 1 latch; installation screws.

Description: Diecast sash lock; spring loaded; used by several window manufacturers.

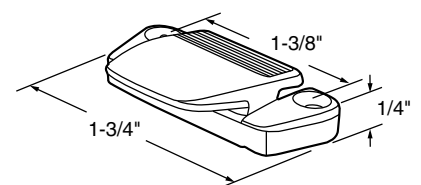

F-2748

Latch and Pull

Contents: 1 latch; installation screws.

Description: Diecast sash lock base; extruded aluminum latch; spring loaded; fits *Keller Industries*® window.

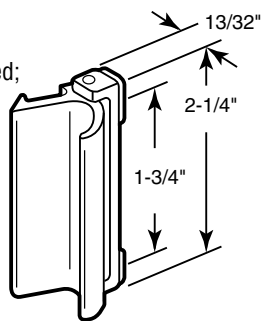

F-2572

Latch and Pull

Contents: 1 latch; installation screws.

Description: Black plastic sash with spring loaded extruded aluminum latch; fits *Premier*® series 510 windows.

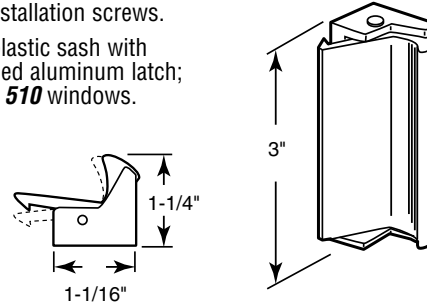

F-2580

Latch and Pull

Contents: 1 latch; installation screws.

Description: Extruded aluminum sash lock; plastic mounting bracket; steel spring; fits *Tomray's*® Tyco series 66 single glazed windows.

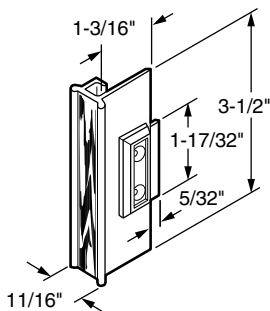

F-2543 (Aluminum)

Latch and Pull

Contents: 1 latch; installation screws.

Description: Extruded aluminum sash lock; plastic mounting bracket; steel spring; fits *Tomray's*® Tyco series 77 dual glazed windows.

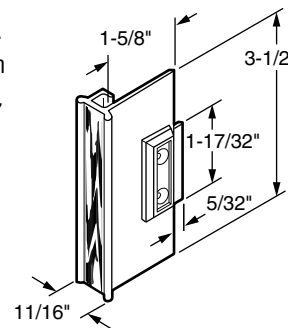

F-2545

Call For Availability

Latch and Pull

Contents: 1 pull with spring latch assembly.

Description: Extruded aluminum sash latch and pull; latches into fixed rail of opposing sash; fits *Ador-Hilite*® windows.

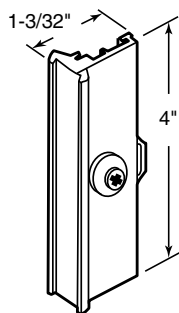

F-2500 (Aluminum)
F-2643 (Black)

Spring Latch Assembly

Contents: 2 nylon latch release buttons; 2 wire springs; installation screws.

Description: Plastic retainer bushing and spring used on the F-2500 *Ador-Hilite*® latch.

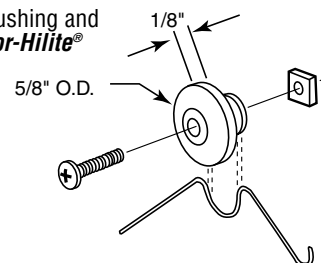

F-2501

Latch and Pull

Contents: 1 pull with spring.

Description: Extruded aluminum latch and pull; fits *International*® Roller King and Queen series windows.

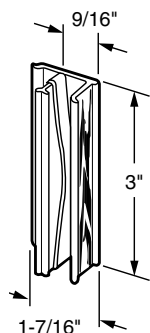

F-2521 (Aluminum)
F-2522 (Black)

Latch and Pull

Contents: 1 pull with spring.

Description: Extruded aluminum latch and pull with wood grain feature strip; self-latching spring-loaded action; fits on *Keller Industries*®.

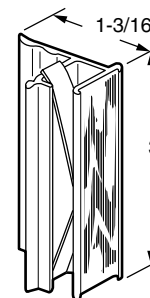

F-2541 (Aluminum)
F-2542 (Bronze)

Call For Availability

Latch and Pull

Contents: 1 pull with spring.

Description: Extruded aluminum latch and pull with wood grain feature strip; self-latching; adjustable; fits on *Daryl Industries*®.

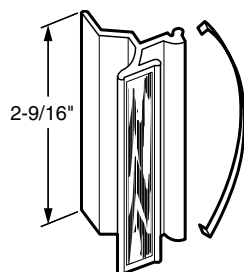

Call For Availability

F-2503

Latch and Pull

Contents: 1 pull with spring.

Description: Black plastic latch and pull; fits on *Rusco-Hilite*® windows.

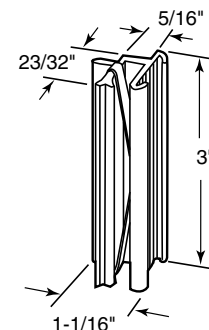

F-2502

Latch and Pull

Contents: 1 pull with spring.

Description: Extruded aluminum latch and pull; fits *International® Imperial* series windows.

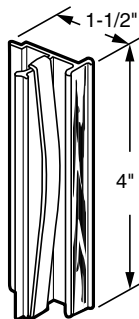

F-2523 (Aluminum) [Call For Availability](#)
F-2524 (Bronze)

Latch and Pull

Contents: 1 pull with spring.

Description: Extruded aluminum latch and pull; fits *Lupton®* windows.

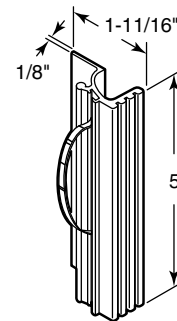

F-2519

[Call For Availability](#)

Latch and Pull

Contents: 1 pull with spring.

Description: Extruded aluminum latch and pull; fits *International® Imperial* series windows.

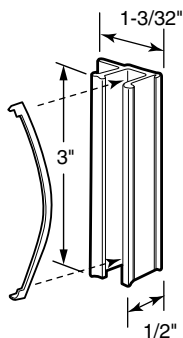

F-2647

[Call For Availability](#)

Latch and Pull

Contents: 1 pull with spring.

Description: Black plastic self-latching handle; position can be raised or lowered for convenience; fits on *Rusco-HiLite®*.

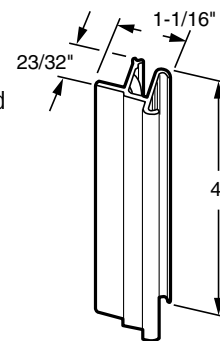

F-2525

Latch and Pull

Contents: 1 pull with spring.

Description: Black plastic latch; fits *Bee Cee®* windows.

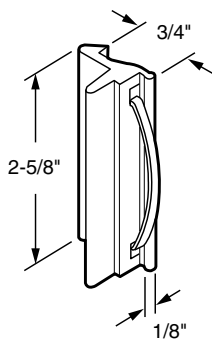

F-2548

Latch and Pull

Contents: 1 latch; 1 spring; installation screws.

Description: Black plastic latch for aluminum sliding windows; fits *Yale-Organ®* windows.

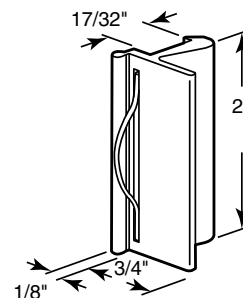

F-2692

Latch and Pull

Contents: 1 pull with spring; installation screws.

Description: Black plastic construction; spring activated latch handle; fits on *Marshall Windows®*.

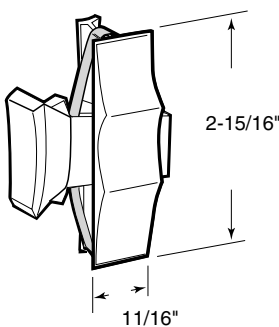

F-2575

[Call For Availability](#)

Latch and Pull

Contents: 1 pull with spring.

Description: Extruded aluminum latch and pull; self latching; spring loaded; fits on *Premiere® integral muntin* windows.

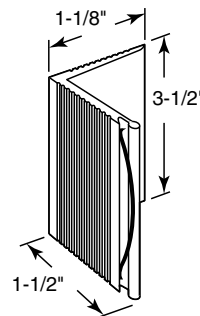

F-2577 (Aluminum)
F-2577-B (Black)
F-2577-W (White)

Latch and Pull

Contents: 1 pull with spring.

Description: Extruded aluminum latch and pull; self latching; spring loaded; fits on *Premiere® dual glazed* windows.

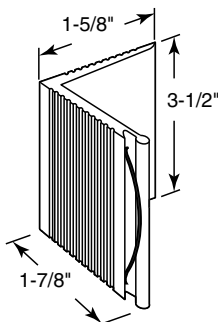

F-2578

[Call For Availability](#)

Latch and Pull

Contents: 1 pull; installation screws.

Description: Gray plastic construction; spring loaded latch; fits on *Cupples®* windows.

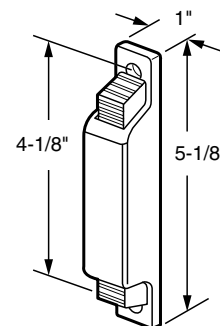

F-2528

[Call For Availability](#)

Latch and Pull

Contents: 1 pull with spring.

Description: White plastic latch activator assembly; fits *Air Control*® / *Keller*® windows.

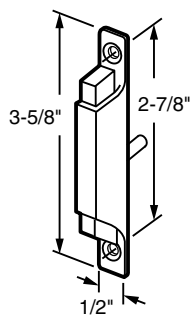

F-2504

Latch

Contents: 2 latches.

Description: Black plastic latch lever; used on manufactured home windows.

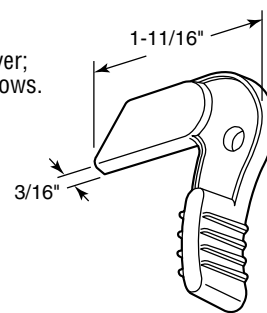

F-2772

Latch

Contents: 1 latch; 1 retainer stud; 1 spring washer.

Description: Black plastic latch; metal retainer stud. fits *Rolleze*® *710 series* windows.

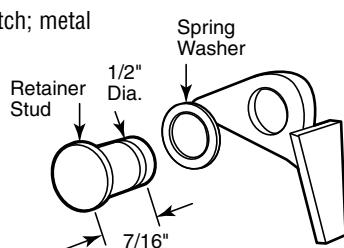

F-2608

Latch

Contents: 1 left hand and 1 right hand latch; 2 binder posts.

Description: Black plastic latches with steel springs; 1 left hand and 1 right hand; fits *Phillips Industries*® single hung windows.

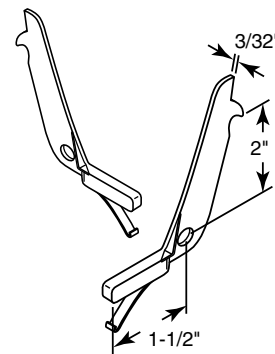

F-2623

Latch

Contents: 1 window latch; 1 lock guide; installation screw.

Description: Black stamped steel latch with plastic guide bracket; fits *Likit*® windows.

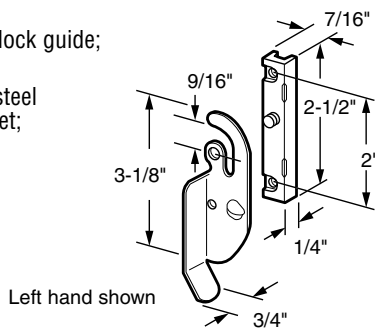

F-2513 (Left)
F-2514 (Right)

Lock

Contents: 1 lock; 1 keeper; installation screws.

Description: Steel housing and strike; bronze powder coat paint; spring-loaded retraction during latching for snug fit; fits on *Hehr*® and others.

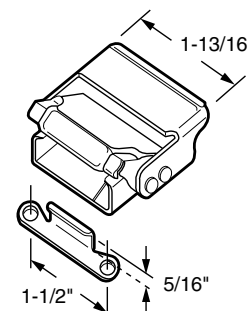

F-2515

Toggle Lock

Contents: 1 lock; 1 keeper; installation screws.

Description: Steel housing and strike; spring-loaded retraction during latching for snug fit.

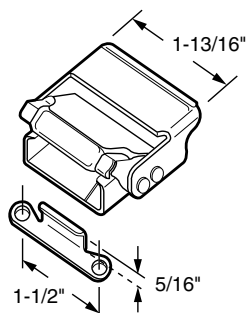

TH-23074 (Bronze)
TH-23075 (Gold)

Latch

Contents: 1 left hand and 1 right hand latch.

Description: Security latch used on awning windows; aluminum finish.

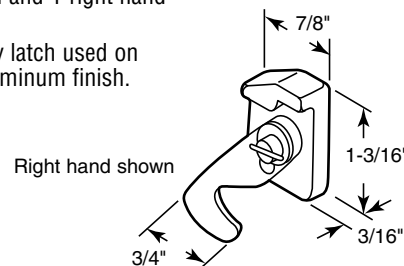

F-2675

Latch and Pull

Contents: 1 pull; installation screws.

Description: Black extruded aluminum handle; stamped steel hook latch; designed for commercial and high-rise windows.

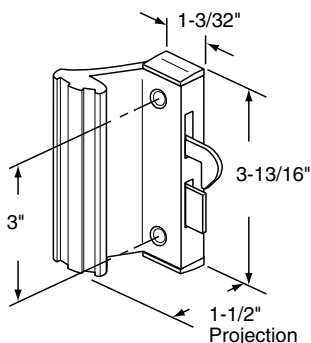

F-2641

Latch and Pull

Contents: 1 pull; installation screws.

Description: Black extruded aluminum pull handle; plastic base; stamped steel clamp latch; designed for commercial and high-rise windows.

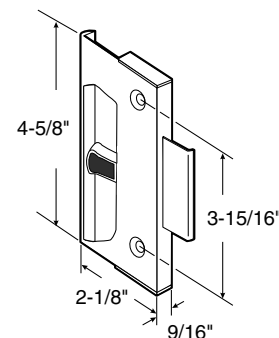

F-2610

Call For Availability

Latch and Keeper

Contents: 1 latch; 1 keeper.

Description: Black diecast security lock and keeper, fits **Acorn**® windows.

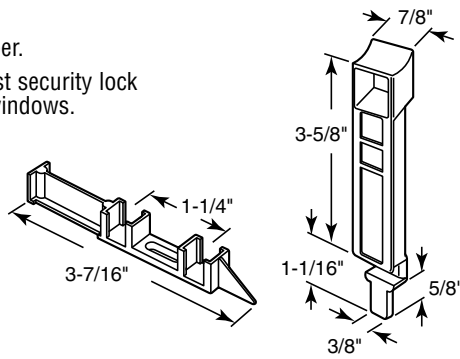

F-2703

Lower Sash Latch

Contents: 2 latches; 2 springs; 2 slide buttons; 2 spring hook retainers.

Description: White plastic slide latch; steel hook and spring; plastic snap on the thumb actuator; non-handed; used on the lower sash; fits **Traco**® windows and others.

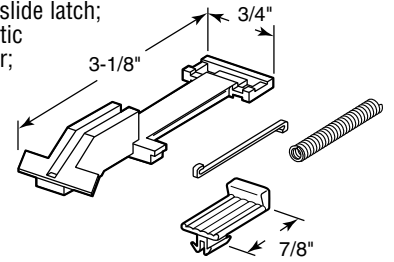

F-2614

Latch and Pull

Contents: 2 latches with springs.

Description: Black plastic latch is non-handed; fits on **Tyko**® **Series 75** single hung sash windows.

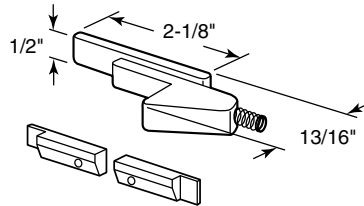

F-2634

Latch

Contents: 1 latch; installation screws.

Description: White plastic latch assembly; spring-loaded; for horizontal sliding windows.



Used primarily in Canada

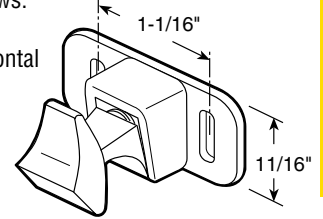

F-2602

Latch

Contents: 1 latch; installation screws.

Description: White plastic latch assembly; spring-loaded; for sliding windows.



Used primarily in Canada

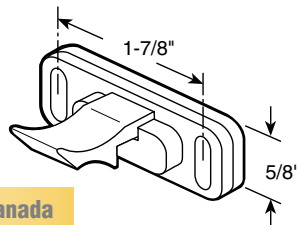

F-2606

Latch

Contents: 1 latch and keeper; installation screws.

Description: Beige plastic latch assembly for aluminum framed windows.

Call For Availability

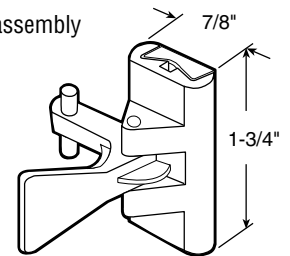

F-2604

Latch

Contents: 1 latch and keeper; installation screws.

Description: Beige plastic latch assembly for aluminum framed windows.

Call For Availability

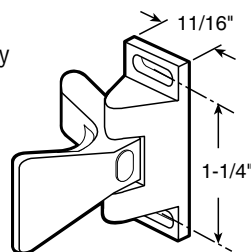

F-2603

SORTED BY HOLE SPACING

Tilt Latch

Contents: 1 left hand and 1 right hand latch.

Description: Spring-loaded, vinyl tilt latch; used on single or double-hung, aluminum or vinyl windows; for use on sash panels designed to tilt in and down from the top.

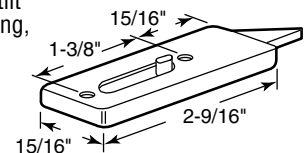

F-2737

Tilt Latch

Contents: 1 left hand and 1 right hand latch.

Description: Spring-loaded, vinyl tilt latch; used on single or double-hung, aluminum or vinyl windows; for use on sash panels designed to tilt in and down from the top.

Call For Availability

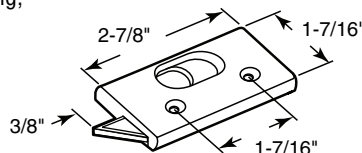

F-2698 (White)

F-2699 (Almond)

Tilt Latch

Contents: 1 left hand and 1 right hand latch.

Description: White; spring-loaded, vinyl tilt latch; used on single or double-hung, aluminum or vinyl windows; for use on sash panels designed to tilt in and down from the top.

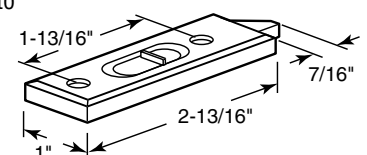

F-2830

Tilt Latch

Contents: 1 left hand and 1 right hand latch.

Description: White; spring-loaded, vinyl tilt latch; used on single or double-hung, aluminum or vinyl windows; for use on sash panels designed to tilt in and down from the top.

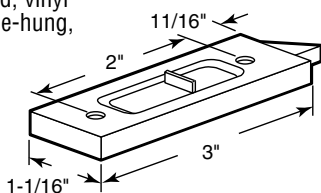

F-2598

Tilt Latch

Contents: 1 left hand and 1 right hand latch.

Description: Spring-loaded, vinyl tilt latch; used on single or double-hung, aluminum or vinyl windows; for use on sash panels designed to tilt in and down from the top; twist lock prevents accidental opening.

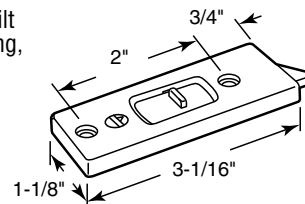

F-2810 (White)
F-2811 (Tan)

Tilt Latch

Contents: 1 left hand and 1 right hand latch.

Description: Spring-loaded, vinyl tilt latch; used on single or double-hung, aluminum or vinyl windows; for use on sash panels designed to tilt in and down from the top.

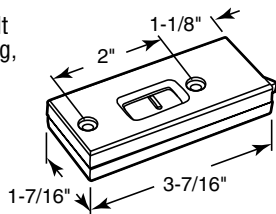

F-2808 (Black)
F-2809 (White)

Tilt Latch

Contents: 1 left hand and 1 right hand latch.

Description: White; spring-loaded, vinyl tilt latch; used on single or double-hung, aluminum or vinyl windows; for use on sash panels designed to tilt in and down from the top.

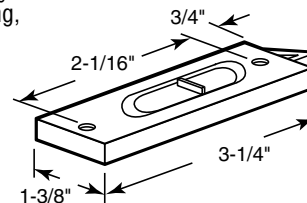

F-2722

Tilt Latch

Contents: 1 left hand and 1 right hand latch.

Description: Spring-loaded, vinyl tilt latch; used on single or double-hung, aluminum or vinyl windows; for use on sash panels designed to tilt in and down from the top.

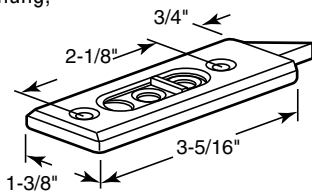

F-2728 (White)
F-2729 (Almond)
F-2730 (Brown)

Tilt Latch

Contents: 1 left hand and 1 right hand latch.

Description: White; spring-loaded, vinyl tilt latch; used on single or double-hung, aluminum or vinyl windows; for use on sash panels designed to tilt in and down from the top.

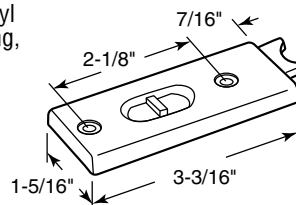

F-2816

Tilt Latch

Contents: 1 left hand and 1 right hand latch.

Description: White; spring-loaded, vinyl tilt latch; used on single or double-hung, aluminum or vinyl windows; for use on sash panels designed to tilt in and down from the top.

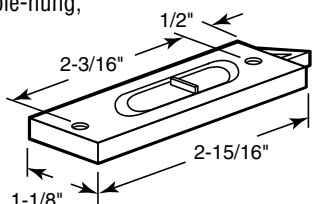

F-2627

Tilt Latch

Contents: 1 left hand and 1 right hand latch.

Description: White; spring-loaded, vinyl tilt latch; used on single or double-hung, aluminum or vinyl windows; for use on sash panels designed to tilt in and down from the top.

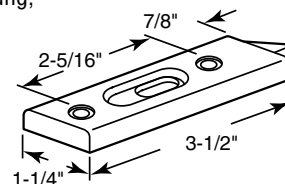

F-2725 (Black)
F-2724 (White)
F-2727 (Almond)

Tilt Latch

Contents: 1 left hand and 1 right hand latch.

Description: White; spring-loaded, vinyl tilt latch; used on single or double-hung, aluminum or vinyl windows; for use on sash panels designed to tilt in and down from the top.

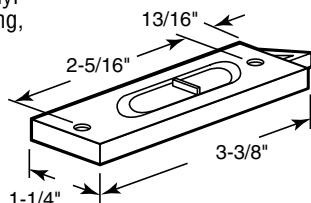

F-2599

Tilt Latch

Contents: 1 left hand and 1 right hand latch.

Description: Spring-loaded, vinyl tilt latch; used on single or double-hung, aluminum or vinyl windows; for use on sash panels designed to tilt in and down from the top; twist lock prevents accidental opening.

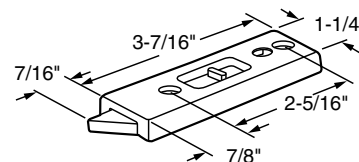

F-2697 (Black)
F-2696 (Almond)

Tilt Latch

Contents: 1 left hand and 1 right hand latch.

Description: White; spring-loaded, vinyl tilt latch; used on single or double-hung, aluminum or vinyl windows; for use on sash panels designed to tilt in and down from the top; twist lock prevents accidental opening.

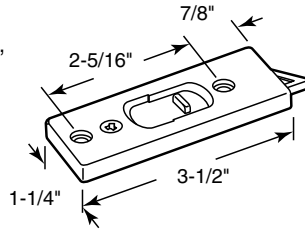

F-2801

Tilt Latch

Contents: 1 left hand and 1 right hand latch.

Description: Cast white bronze; spring-loaded, tilt latch; used on single or double-hung, aluminum or vinyl windows; for use on sash panels designed to tilt in and down from the top.

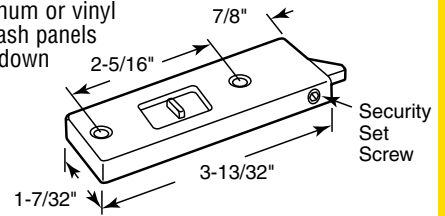

F-2831

Tilt Latch

Contents: 1 left hand and 1 right hand latch.

Description: Spring-loaded, vinyl tilt latch; used on single or double-hung, aluminum or vinyl windows; for use on sash panels designed to tilt in and down from the top.

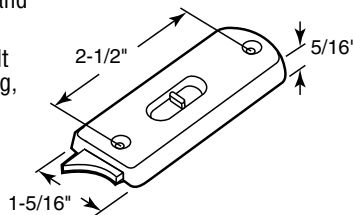

F-2695 (Black)
F-2693 (White)
F-2694 (Almond)

Call For Availability

Tilt Latch

Contents: 1 left hand and 1 right hand latch.

Description: Spring-loaded, vinyl tilt latch; used on single or double-hung, aluminum or vinyl windows; for use on sash panels designed to tilt in and down from the top.

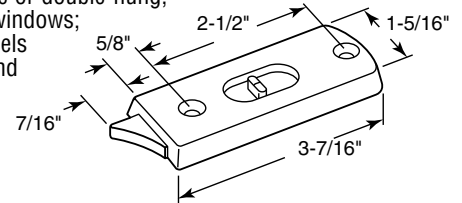

F-2828 (Black)
F-2829 (White)

Tilt Latch

Contents: 1 left hand and 1 right hand latch.

Description: White; spring-loaded, vinyl tilt latch; used on single or double-hung, aluminum or vinyl windows; for use on sash panels designed to tilt in and down from the top.

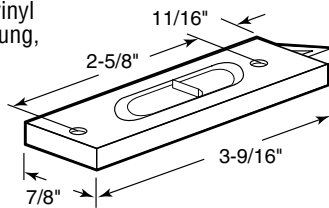

F-2671

Tilt Latch

Contents: 1 left hand and 1 right hand latch.

Description: Black; spring-loaded, vinyl tilt latch; used on single or double-hung, aluminum or vinyl windows; for use on sash panels designed to tilt in and down from the top; twist lock prevents accidental opening.

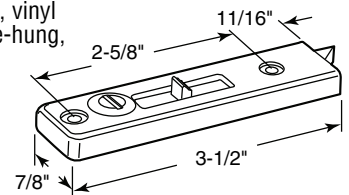

F-2735

Call For Availability

Tilt Latch

Contents: 1 left hand and 1 right hand latch.

Description: White; spring-loaded, vinyl tilt latch; used on single or double-hung, aluminum or vinyl windows; for use on sash panels designed to tilt in and down from the top.

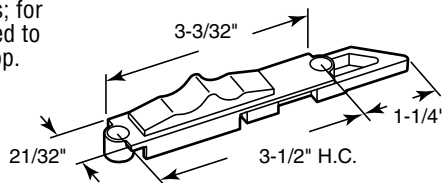

F-2832

Tilt Latch

Contents: 1 left hand and 1 right hand latch.

Description: White plastic tilt latch; spring loaded; designed for mortised installation.

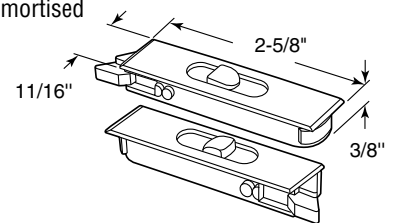

F-2749

Tilt Latch

Contents: 1 left hand and 1 right hand latch.

Description: White plastic tilt latch; spring loaded; designed for mortised installation.

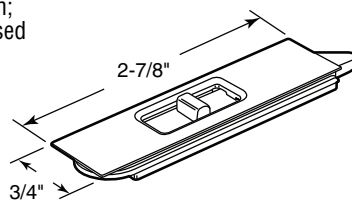

F-2734

Tilt Latch

Contents: 1 left hand and 1 right hand latch.

Description: Black plastic tilt latch; non-handed; fits Acorn® windows.

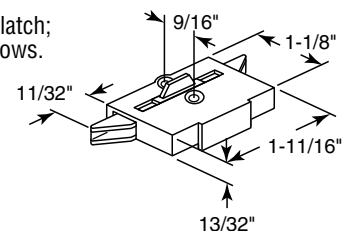

F-2645

Tilt Latch

Contents: 2 latches.

Description: Non-handed tilt latch; black finish; used by several manufacturers.

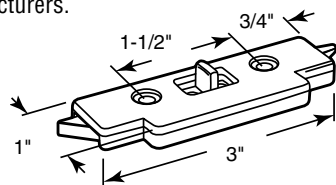

F-2815

Tilt Latch

Contents: 1 left hand and 1 right hand latch.

Description: Plastic tilt latch; spring loaded; fits **Better Built**® windows.

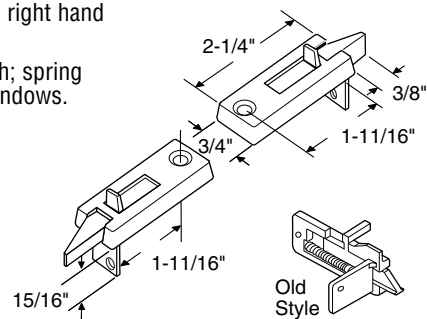

F-2628 (Black)
F-2642 (White)

Tilt Latch

Contents: 1 left hand and 1 right hand latch.

Description: White plastic tilt latch; spring loaded; used by several window manufacturers.

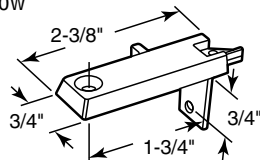

Right Hand Shown

F-2814

Tilt Latch

Contents: 1 left hand and 1 right hand latch.

Description: Plastic tilt latch; spring loaded; fits **Keller**® windows.

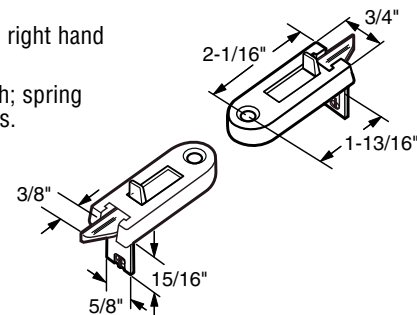

F-2660 (Black)
F-2788 (White)

Tilt Latch

Contents: 2 latches.

Description: Black plastic tilt latch; fits **Keller**® windows.

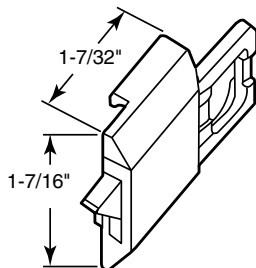

F-2769

Tilt Latch

Contents: 1 left hand and 1 right hand latch.

Description: Black plastic tilt latch; fits **Binnings**® windows.

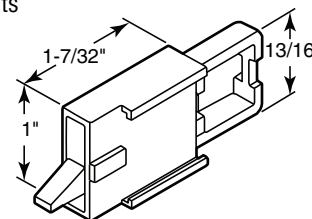

F-2770

Tilt Latch

Contents: 2 latches.

Description: Black vinyl window tilt latch; spring loaded; used by several window manufacturers.

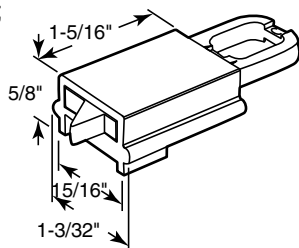

F-2813

Tilt Latch

Contents: 1 left hand and 1 right hand latch.

Description: White vinyl window tilt latch; spring loaded; used by several window manufacturers.

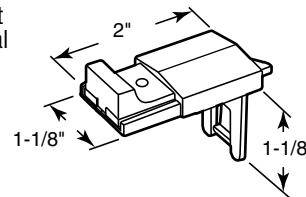

F-2812

Tilt Latch

Contents: 1 left hand and 1 right hand latch.

Description: White vinyl window tilt latch; spring loaded; used by several window manufacturers.

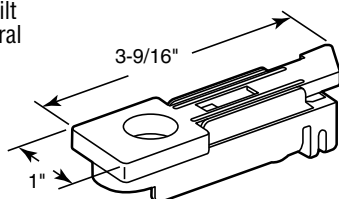

F-2821

Tilt Latch

Contents: 1 left hand and 1 right hand latch.

Description: Tan vinyl window tilt latch; spring loaded; used by several window manufacturers.

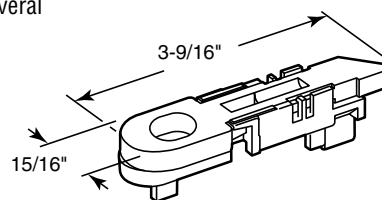

F-2822

Tilt Slide Button

Contents: 1 button.

Description: White plastic activation button used on mortise style tilt latches similar to F-2822; fits **Harvey®** windows.

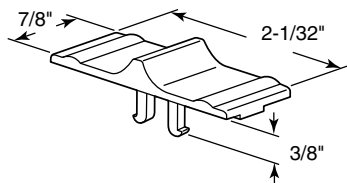

F-2825

Tilt Slide Button

Contents: 1 button.

Description: White plastic activation button used on mortise style tilt latches.

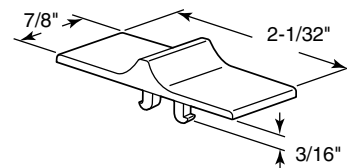

F-2826 (Brown)
F-2827 (Beige)

Weep Hole Cover

Contents: 4 covers.

Description: White plastic weep hole cover for vinyl windows; screw mounted.

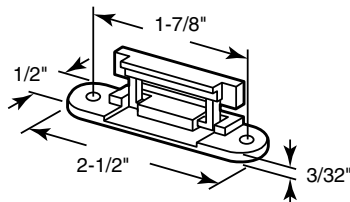

F-2794

Weep Hole Cover

Contents: 4 covers.

Description: White plastic weep hole cover for vinyl windows; press fit.

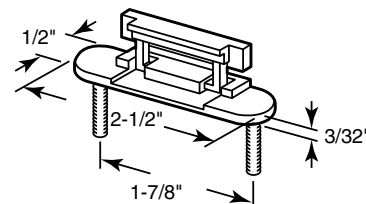

F-2793

Vent Stop

Contents: 2 stops.

Description: White stop for single or double hung vinyl windows; fits 9/16" x 1" cutout; snap-in design.

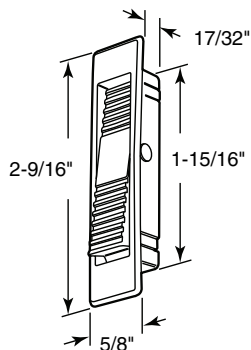

F-2736

Vinyl Window Limit Latch

Contents: 2 latches.

Description: White stop for single or double hung vinyl windows; fits 9/16" x 1" cutout; snap-in design.

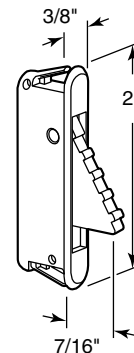

F-2824

Acrylic Knob

Contents: 2 knobs.

Description: Clear knob used on sliding pass-thru windows and sliding medicine cabinet panels; accommodates up to a 1/4" thick panel; fits a 9/32" diameter hole.

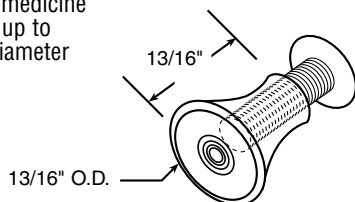

F-2616

Pass-Thru Finger Pull

Contents: 2 pulls.

Description: Adhesive-backed plastic handle; easy installation; universal application.

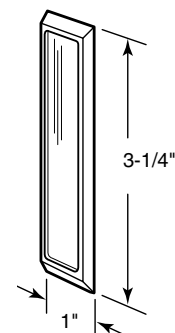

F-2549 (Clear)
F-2550 (Black)
F-2551 (Gold)

Pull

Contents: 1 pull; installation screws.

Description: Black plastic construction; universal application; can be used as a secondary pull or a child's pull.

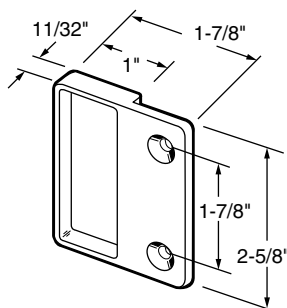

F-2547

Call For Availability