

G-3018

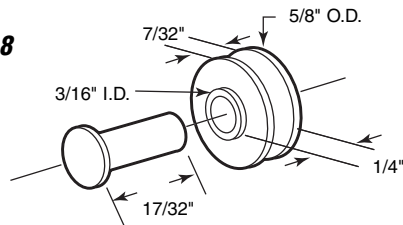

G-3018

Roller

Contents: 4 rollers; 4 axle pins.

Description: 7/32" x 5/8" center grooved nylon roller; aluminum rivet type axle pins; fits on *Air Control*.

You may wish to stock these related parts: **F-2504, F-2541.**

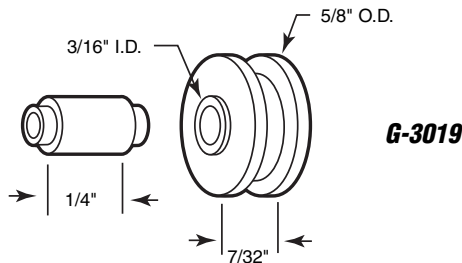

G-3019

Roller

Contents: 4 rollers; 4 axle pins.

Description: 7/32" x 5/8" center-grooved nylon roller; aluminum axle pins; repair part for **G-3021**; fits on *Trimview*.

You may wish to stock these related parts: **G-3020.**

G-3020

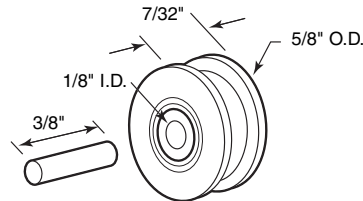

G-3020

Roller

Contents: 4 rollers; 4 axle pins.

Description: 7/32" x 5/8" center-grooved nylon ball bearing roller; aluminum axle pins; repair part for **G-3021**; fits on *Trimview*.

You may wish to stock these related parts: **G-3019.**

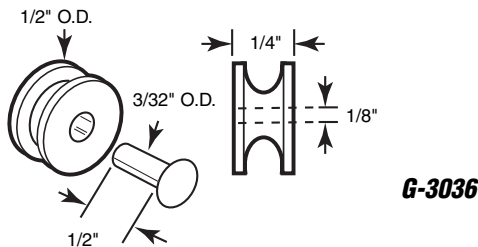

G-3036

Roller

Contents: 4 rollers; 4 axle pins.

Description: 1/4" x 1/2" nylon roller; deep center groove; accepts a 1/8" rivet style axle; used by several sliding window manufacturers.

G-3040

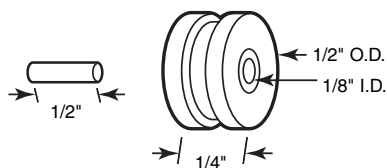

G-3040

Roller

Contents: 4 rollers; 4 axle pins.

Description: 1/4" x 1/2" nylon roller with center groove; aluminum axle pins; used by several sliding window manufacturers.

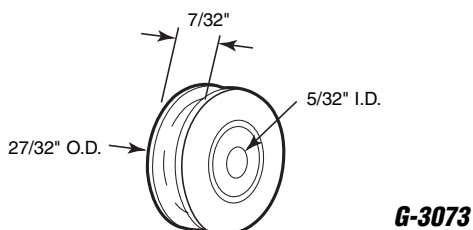

G-3073

Roller

Contents: 2 rollers.

Description: 7/32" x 27/32" diameter steel ball bearing roller with center groove; used on sliding aluminum windows.

You may wish to stock these related parts: **G-3014.**

Sliding Window Rollers & Guides

G-3090

Roller

Contents: 2 rollers.

Description: 5/16" x 3/4" nylon roller; 1/8" narrow groove; fits on *Ralley* windows.

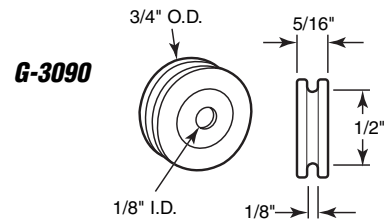

G-3015 (Steel)

G-3098 (Stainless steel)

Roller

Contents: 4 rollers; 4 axle pins.

Description: 1/8" x 7/16" flat steel roller; nylon axle pins; fits on *Premiere*.

You may wish to stock these related parts: G-3060, G-3088, G-3136.

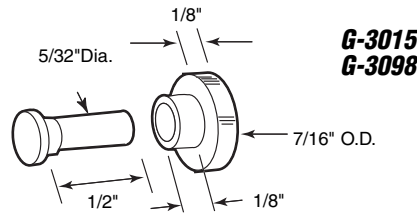

G-3016

Roller

Contents: 4 rollers; 4 axle pins.

Description: 5/32" x 7/16" flat nylon roller; nylon axle pins; fits on *HiLite*.

You may wish to stock these related parts: F-2500, F-2502, F-2525.

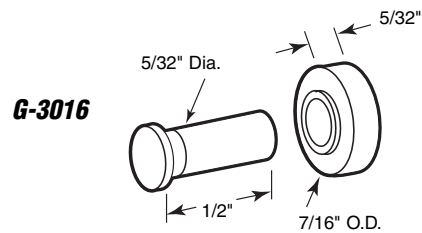

G-3017

Roller

Contents: 8 rollers; 8 axle pins.

Description: 9/32" x 3/8" flat nylon roller; aluminum rivet style axle pins; repair part for G-3005.

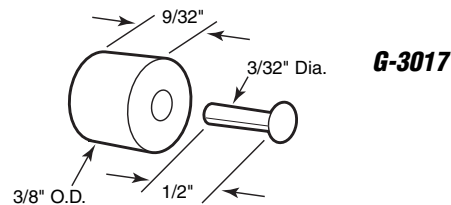

G-3031

Roller

Contents: 4 rollers; 4 axle pins.

Description: 5/16" x 7/32" flat nylon roller; nylon axle pins; fits on *Radco*.

You may wish to stock these related parts: G-3028, G-3029, G-3030, G-3062, G-3153.

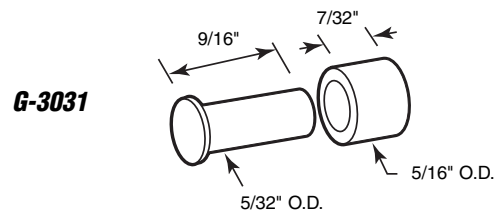

G-3060

Roller

Contents: 4 rollers; 4 axle pins.

Description: 3/16" x 1/2" flat steel roller; nylon axle pins; fits on *Western*, *Premiere* and *Keller* windows.

You may wish to stock these related parts: F-2541, F-2542, G-3088.

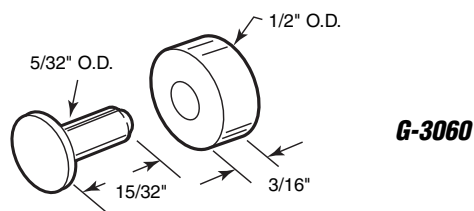

G-3082

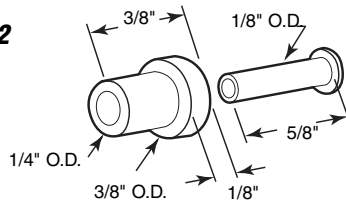

G-3082

Roller

Contents: 2 rollers; 2 axles.

Description: 1/8" x 3/8" steel roller; rivet style steel axles; fits on *Fullview* windows.

You may wish to stock these related parts: **F-2553, G-3009, G-3010, G-3011, G-3026.**

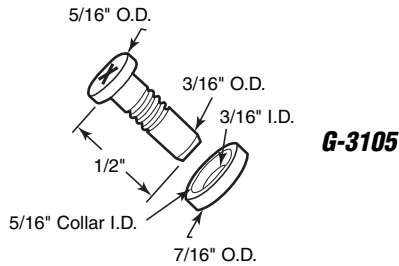

G-3105

G-3105

Roller and Axle Screw

Contents: 2 axle screws; 2 roller bushings.

Description: Steel axle screw with nylon roller; fits on *Rolleze* windows.

You may wish to stock these related parts: **F-2553, F-2608, G-3065.**

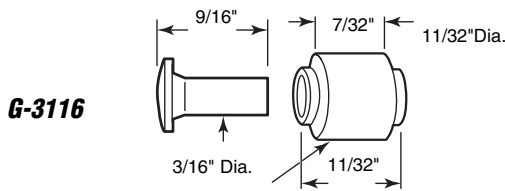

G-3116

G-3116

Roller

Contents: 2 rollers; 2 axles.

Description: Solid brass rollers with nylon axles; fits on *Viking Series M70* windows.

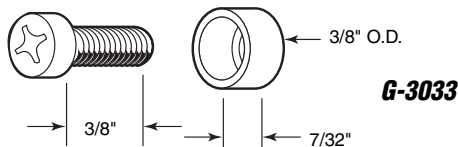

G-3033

G-3033

Roller

Contents: 4 rollers; 4 no. 8-32 x 3/8" Phillips pan head machine screws.

Description: Nylon roller assembly; fits on *C & P Window*.

You may wish to stock these related parts: **F-2520, G-3032.**

Call for Availability

G-3034

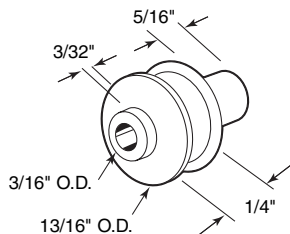

G-3034

Roller

Contents: 4 rollers.

Description: 1/4" x 13/16" nylon roller; extended hub; fits on *Cupples* windows.

You may wish to stock these related parts: **F-2528.**

Call for Availability

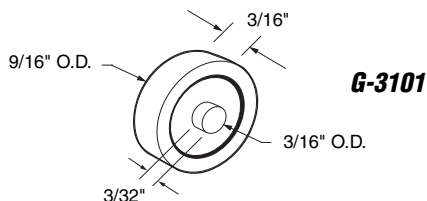

G-3101

G-3101

Roller

Contents: 2 rollers.

Description: 3/16" x 9/16" steel ball bearing roller; replacement roller for *G-3072*; fits on *Thermo Glide, Bee Cee* and others.

You may wish to stock these related parts: **G-3047, G-3056.**

Sliding Window Rollers & Guides

G-3092

Roller Assembly

Contents: 2 roller assemblies.

Description: Stamped steel housing with 7/16" diameter center groove nylon roller; used on sliding storm windows and showcase windows.

You may wish to stock these related parts: **G-3035, G-3087, G-3093, G-3094, G-3095.**

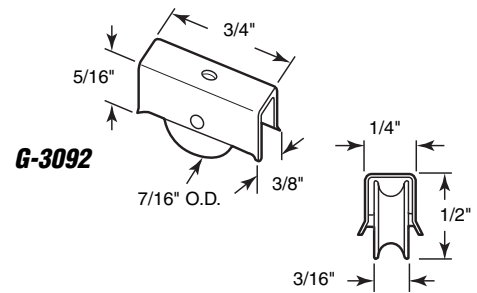

G-3093

Roller Assembly

Contents: 2 roller assemblies.

Description: Stamped steel housing with 3/8" diameter convex nylon roller; used on sliding storm windows and showcase windows.

You may wish to stock these related parts: **G-3035, G-3087, G-3092, G-3094, G-3095.**

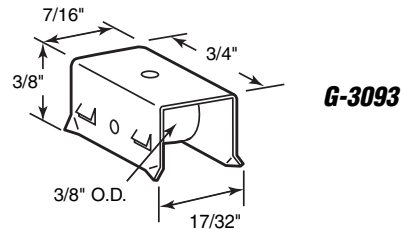

G-3094 (Nylon roller)

G-3095 (Steel roller)

Roller Assembly

Contents: 2 roller assemblies.

Description: Stamped steel housing with 9/16" diameter center groove roller; used on sliding storm windows and showcase windows.

You may wish to stock these related parts: **G-3035, G-3041, G-3087, G-3092, G-3093.**

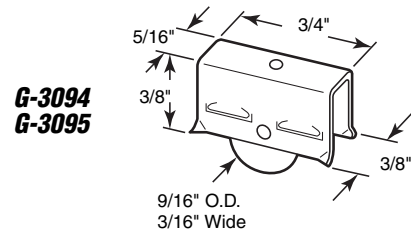

G-3123

Roller Assembly

Contents: 2 roller assemblies.

Description: Stamped steel housing with 5/16" diameter flat edge nylon roller; used on sliding storm windows and showcase windows.

You may wish to stock these related parts: **G-3035, G-3087, G-3092, G-3094, G-3095.**

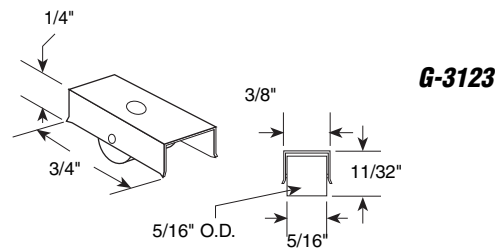

G-3128

Roller Assembly

Contents: 2 roller assemblies.

Description: Stamped steel housing; flat edge nylon roller; used on sliding windows and showcase doors.

You may wish to stock these related parts: **G-3035, G-3087, G-3092, G-3093, G-3095.**

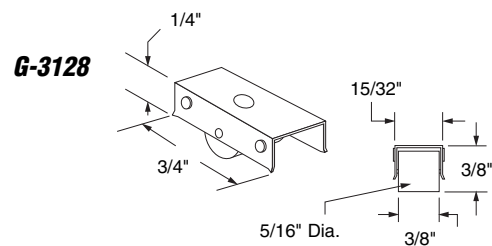

G-3125

Roller Assembly

Contents: 2 roller assemblies.

Description: Stamped steel housing with 9/16" diameter flat edge nylon roller; used on sliding storm windows and showcase windows.

You may wish to stock these related parts: **G-3035, G-3087, G-3093, G-3094, G-3095.**

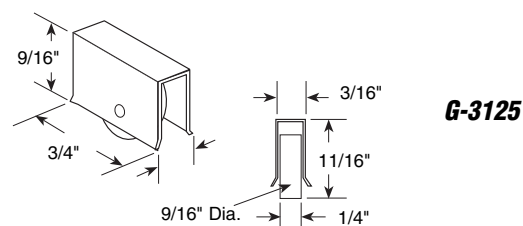

G-3035
G-3087

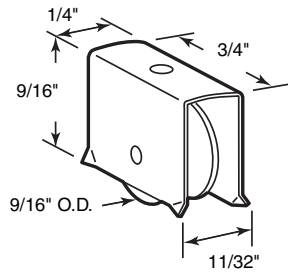

G-3035 (Steel roller)
G-3087 (Nylon roller)

Roller Assembly

Contents: 2 roller assemblies.

Description: Stamped steel housing with 9/16" diameter concave roller; used on sliding windows and showcase windows.

You may wish to stock these related parts: **F-2549**, **F-2550**, **F-2551**.

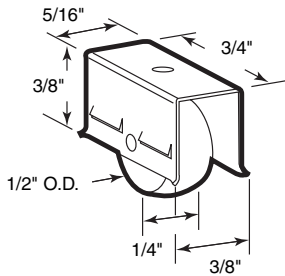

G-3041

G-3041

Roller Assembly

Contents: 2 roller assemblies.

Description: Stamped steel housing; 1/4" x 1/2" convex nylon roller.

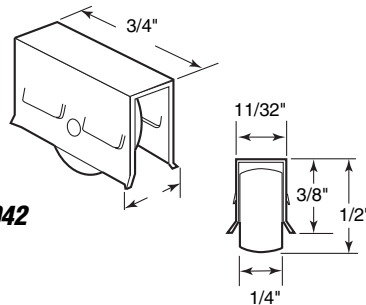

G-3042

G-3042

Roller Assembly

Contents: 2 roller assemblies.

Description: Extruded aluminum housing; flat edge steel roller.

Call for
Availability

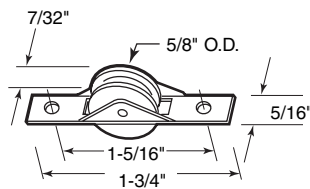

G-3039

G-3039

Roller Assembly

Contents: 2 roller assemblies.

Description: Stamped steel housing; concave nylon roller; fits on *Fullview* windows.

You may wish to stock these related parts: **F-2553**.

G-3053

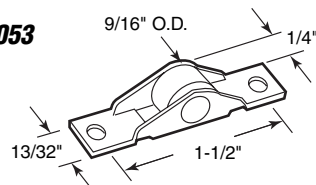

G-3053

Roller Assembly

Contents: 2 roller assemblies.

Description: Steel housing with 9/16" diameter flat edge nylon roller; used on sliding storm and showcase windows.

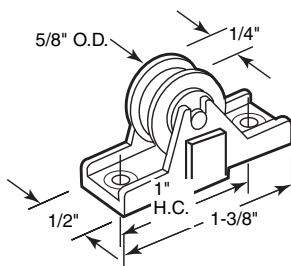

G-3051

G-3051

Roller Assembly

Contents: 2 roller assemblies.

Description: Nylon housing; center-grooved steel ball bearing roller; used by several window manufacturers.

Sliding Window Rollers & Guides

G-3052 (Steel - 5/8" diameter x 3/16" thick)
G-3152 (Nylon - 3/4" diameter x 1/4" thick)

Roller Assembly

Contents: 2 roller assemblies.

Description: Nylon housing; flat edge roller; used by several window manufacturers.

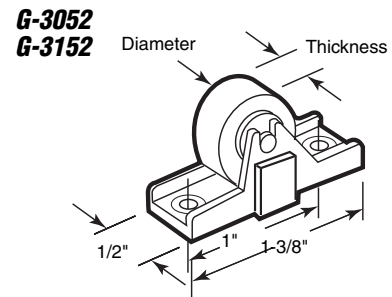

G-3000

Roller Assembly

Contents: 2 roller assemblies.

Description: Aluminum bracket with 1/8" x 1/2" flat edge nylon roller; fits on *International "King-Queen"* series, also fits on *Academy* and *A-1 Aluminum*.

You may wish to stock these related parts: **F-2517**, **F-2521**, **F-2522**.

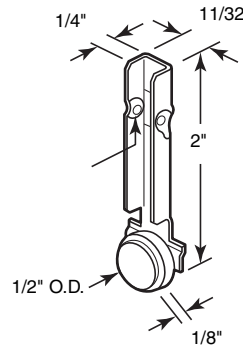

G-3000

G-3135

Roller Assembly

Contents: 2 roller assemblies.

Description: Aluminum bracket with 1/8" x 1/2" flat edge nylon roller; fits on *Century-Elco* windows.

You may wish to stock these related parts: **G-3118**, **G-3122**.

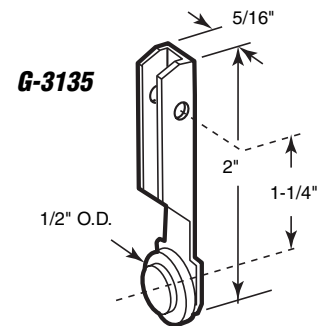

G-3135

G-3001 (Nylon roller)

Roller Assembly

Contents: 2 rollers assemblies.

Description: Aluminum bracket with 1/8" x 5/8" flat edge roller; fits on *International* windows.

You may wish to stock these related parts: **F-2517**, **F-2521**, **F-2522**.

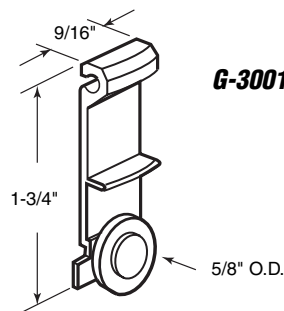

G-3001

G-3102

Roller Assembly

Contents: 2 roller assemblies.

Description: Extruded aluminum bracket; 1/8" x 1/2" flat edge steel roller; fits on *International* windows.

You may wish to stock these related parts: **F-2517**, **F-2521**, **F-2522**.

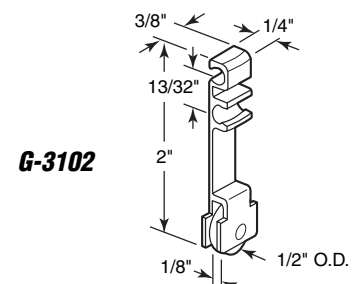

G-3102

G-3124

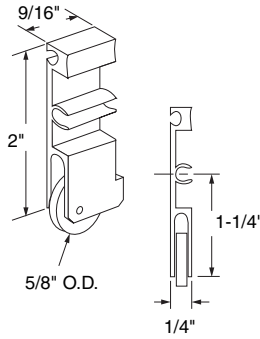

G-3124 (Steel ball bearing)

Roller Assembly

Contents: 2 roller assemblies.

Description: Extruded aluminum bracket with 1/8" x 1/2" steel ball bearing roller; fits on *International* windows and others.

G-3137

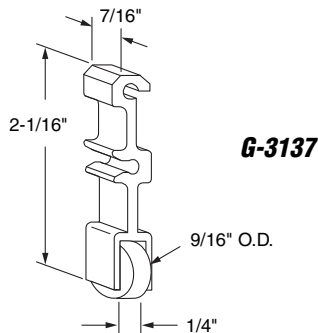

Roller Assembly

Contents: 2 roller assemblies.

Description: Extruded aluminum bracket; 1/4" x 9/16" diameter heavy duty steel roller; fits on *International* insulated glass windows.

G-3137

G-3138

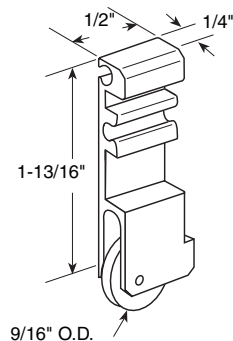

G-3138

Roller Assembly

Contents: 2 roller assemblies.

Description: Extruded aluminum bracket; 1/8" x 9/16" solid brass roller; fits on *Guaranteed Products* and others.

You may wish to stock these related parts: **F-2512, F-2597, F-2647.**

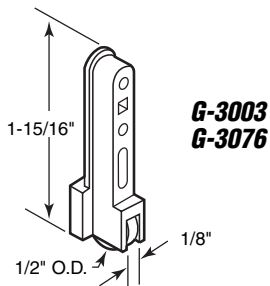

**G-3003
G-3076**

G-3003 (Nylon roller - 4 per card)

G-3076 (Steel roller - 2 per card)

Roller Assembly

Contents: Roller assemblies.

Description: Nylon housing; 1/8" x 1/2" flat roller; top rollers adjust "up" to provide anti-lift protection; bottom rollers adjust "up and down" for alignment; fits on *Hilite 200 Series* windows.

You may wish to stock these related parts: **F-2500, F-2502, F-2543.**

G-3004

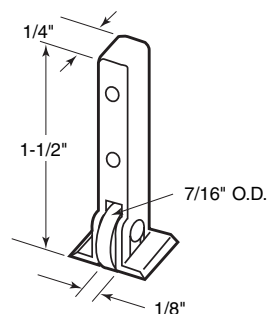

G-3004

Roller Assembly

Contents: 4 roller assemblies.

Description: Nylon housing; 1/8" x 7/16" flat edge nylon roller; fits on *Guaranteed Products*.

You may wish to stock these related parts: **F-2512, F-2597, F-2647.**

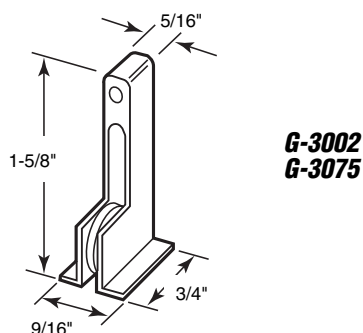

**G-3002
G-3075**

G-3002 (Nylon roller)

G-3075 (Steel roller)

Roller Assembly

Contents: 2 rollers assemblies.

Description: Nylon housing, with 1/8" x 1/2" flat edge roller; fits on *HiLite* convertible windows.

You may wish to stock these related parts: **F-2500, F-2501, F-2543.**

Sliding Window Rollers & Guides

G-3083

Roller Assembly

Contents: 2 roller assemblies.

Description: Nylon housing; 1/8" x 3/8" nylon roller; fits on *Guaranteed* windows.

You may wish to stock these related parts: **F-2512, F-2597, F-2647.**

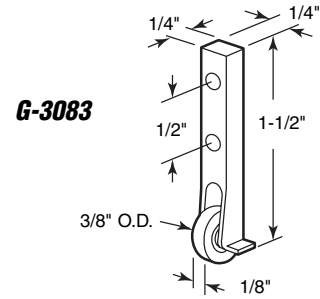

G-3084 (1/16" guide leg)

G-3085 (1/8" guide leg)

Roller Assembly

Contents: 2 roller assemblies.

Description: Gray nylon housing; 1/8" x 1/2" nylon roller; fits on *A-1 Aluminum, Horizon, Sun Air, International, Patio Concepts* and others.

You may wish to stock these related parts: **F-2512, F-2517, F-2521.**

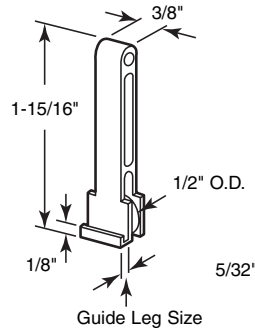

**G-3084
G-3085**

G-3088

Roller Assembly

Contents: 2 roller assemblies.

Description: Black nylon housing; nylon roller; 1/16" guide leg; fits on *Premiere* and others.

You may wish to stock these related parts: **G-3084, G-3085.**

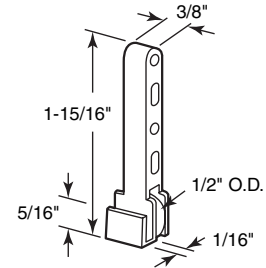

G-3088

G-3032

Roller Assembly

Contents: 4 roller assemblies.

Description: Nylon adjustable housing; 1/4" x 7/16" nylon roller; fits on *C & P Window*.

You may wish to stock these related parts: **F-2520, G-3033.**

Call for
Availability

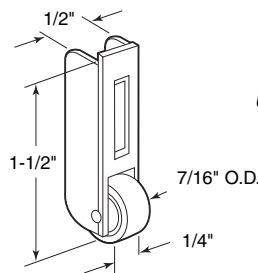

G-3032

G-3077 (Nylon roller)

G-3156 (Brass roller)

Roller Assembly

Contents: 2 roller assemblies.

Description: Stamped aluminum housing; 1/8" x 1/2" roller; fits on *International* windows.

You may wish to stock these related parts: **F-2517, F-2521, F-2522, G-3000, G-3001, G-3102.**

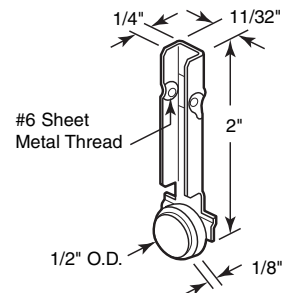

**G-3077
G-3156**

G-3005

Roller Assembly

Contents: 4 roller assemblies.

Description: Adjustable bracket with 9/32" x 3/8" flat edge nylon roller; used by several window manufacturers.

You may wish to stock these related parts: **G-3017.**

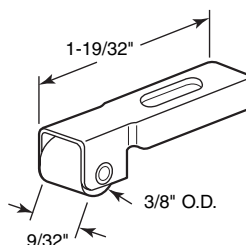

G-3005

Call for
Availability

G-3067
G-3068

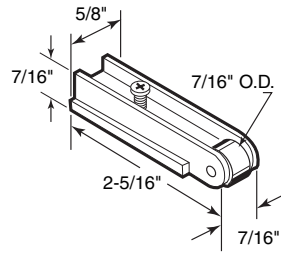

G-3067 (Aluminum finish)
G-3068 (Bronze finish)

Roller Assembly

Contents: 2 roller assemblies.

Description: Extruded aluminum housing; 7/16" diameter nylon roller; fits on *Bell* windows.

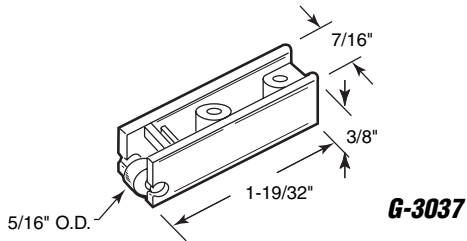

G-3037

G-3037

Roller Assembly

Contents: 4 roller assemblies.

Description: Nylon housing with flat edge nylon roller; fits on *Air Flow* patio windows.

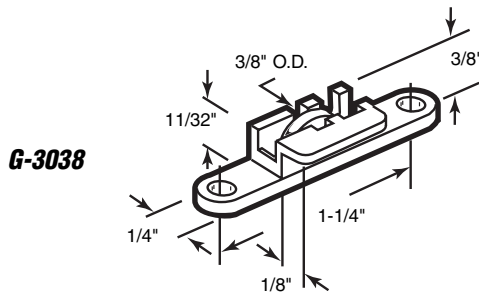

G-3038

G-3038 (Steel roller)

Roller Assembly

Contents: 4 roller assemblies

Description: Nylon housing with flat edge steel roller; fits on *Tomrays Tyco 66* windows.

You may wish to stock these related parts: **F-2543, F-2544.**

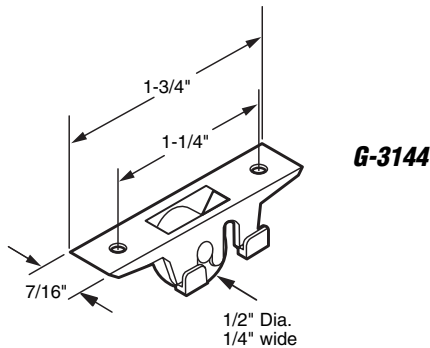

G-3144

G-3144 (Nylon roller)

Roller Assembly

Contents: 2 roller assemblies

Description: White nylon housing; solid brass axles; fits on *Guaranteed Products* and others.

You may wish to stock these related parts: **F-2512, F-2597, F-2647.**

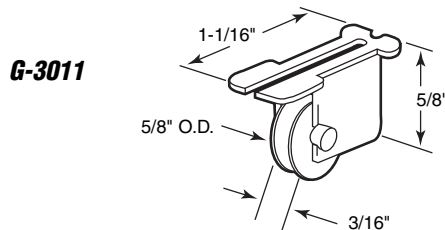

G-3011

G-3011

Roller Assembly

Contents: 2 roller assemblies.

Description: Nylon housing; 3/16" x 5/8" steel roller; fits on *Fullview*.

You may wish to stock these related parts: **F-2553.**

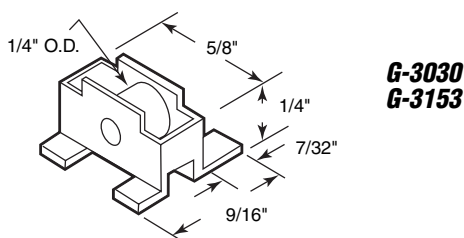

G-3030
G-3153

G-3030 (Nylon roller - 4 per card)

G-3153 (Brass roller - 2 per card)

Roller Assembly

Contents: Roller assemblies.

Description: Offset guide leg; flat edge roller; nylon housing; fits on *Radco* and *Glass Emporium*.

You may wish to stock these related parts: **G-3028, G-3029, G-3031, G-3062.**

Sliding Window Rollers & Guides

G-3050

Roller Assembly

Contents: 4 roller assemblies.

Description: Nylon housing; flat edge nylon ball bearing roller.

G-3050

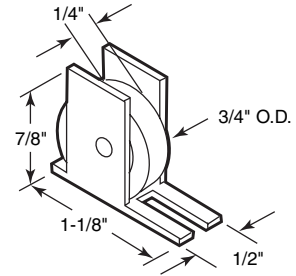

G-3106

Roller Assembly

Contents: 2 roller assemblies.

Description: Nylon housing with 7/16" diameter steel, center-grooved roller; fits on *Krestmark*.

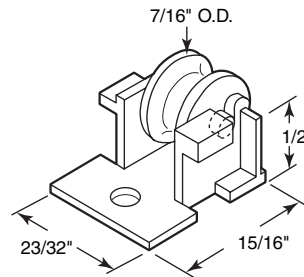

G-3106

G-3147

Roller Assembly

Contents: 2 roller assemblies.

Description: White nylon housing; nylon concave roller; fits on *H-R Windows* and others.

G-3147

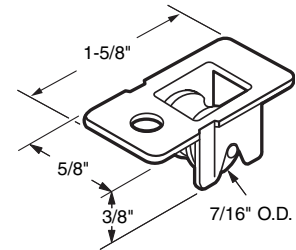

G-3055

Roller Assembly

Contents: 2 roller assemblies.

Description: Nylon housing; flat edge nylon roller; fits on *Acorn* old style windows.

You may wish to stock these related parts: **F-2645, G-3058.**

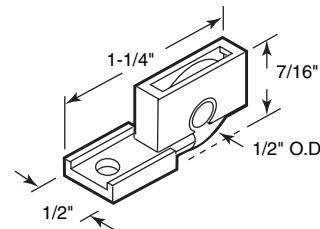

G-3055

G-3056

Roller Assembly

Contents: 2 roller assemblies.

Description: Nylon housing; flat edge nylon roller; fits on *Bee Cee* and other windows.

You may wish to stock these related parts: **F-2645, G-3058.**

Call for Availability

G-3056

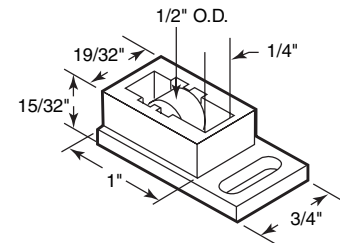

G-3167

Roller Assembly

Contents: 2 roller assemblies.

Description: Nylon housing; flat edge steel roller; fits on *Pennco* and others.

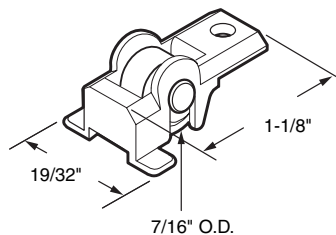

G-3167

G-3151

Roller Assembly

Contents: 2 roller assemblies.

Description: Black nylon housing; 17/32" diameter solid brass flat edge roller; brass axle; fits on *Rollyson Series 400* windows.

G-3151

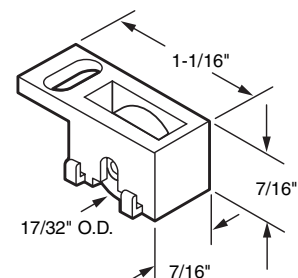

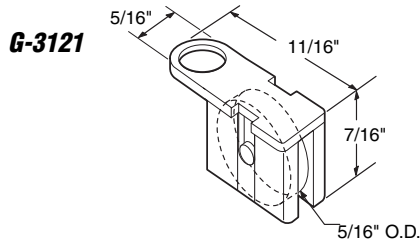

G-3121

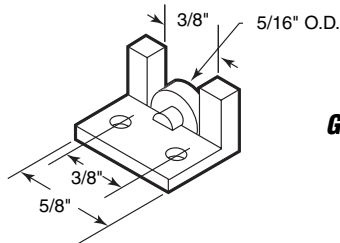

G-3061

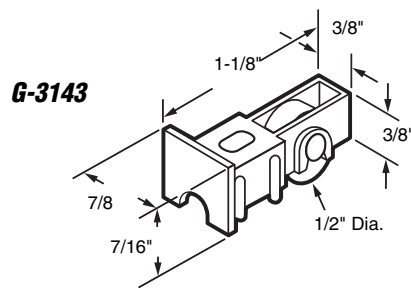

G-3143

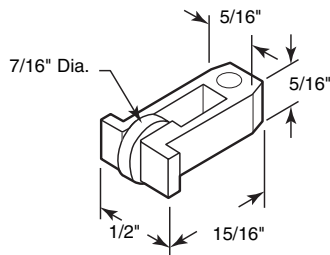

G-3108

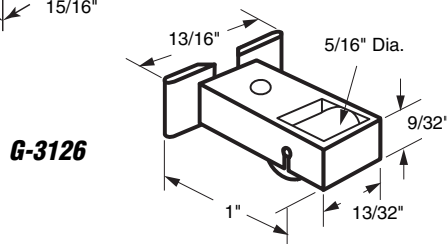

G-3126

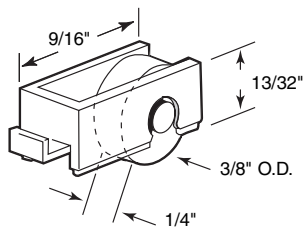

G-3009

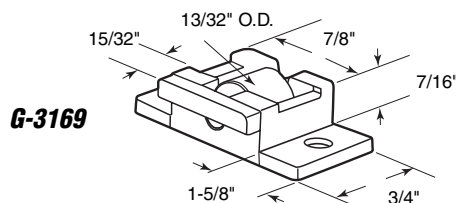

G-3169

G-3121

Roller Assembly

Contents: 2 roller assemblies.

Description: Nylon housing; 5/16" diameter solid brass flat edge roller; fits on *Better-Bilt*.

You may wish to stock these related parts: F-2526, F-2627, F-2628, F-2642, G-3086.

G-3061

Roller Assembly

Contents: 2 roller assemblies.

Description: Nylon guide bracket; 5/16" diameter flat edge brass roller; fits on *Eico/Century* windows.

You may wish to stock these related parts: G-3118, G-3122, G-3135.

G-3143

Roller Assembly

Contents: 2 roller assemblies.

Description: Black nylon housing; 3/16" x 1/2" steel roller; fits on *Sun-Air* and others.

You may wish to stock these related parts: G-3084.

G-3108

Roller Assembly

Contents: 2 roller assemblies.

Description: Nylon housing and guide; 7/16" diameter flat edge steel roller.

G-3126

Roller Assembly

Contents: 2 roller assemblies.

Description: Nylon housing with 5/16" diameter flat edge steel roller.

G-3009

Roller Assembly

Contents: 2 roller assemblies.

Description: Nylon housing with 1/4" x 3/8" flat edge steel roller; fits on *Fullview* windows.

You may wish to stock these related parts: F-2553, G-3010, G-3011, G-3025, G-3026, G-3039, G-3082.

G-3169

Roller Assembly

Contents: 2 roller assemblies.

Description: Black Nylon housing with 13/32" diameter solid brass roller; fits on *Amsco* windows.

Sliding Window Rollers & Guides

G-3013

Roller Assembly

Contents: 4 roller assemblies.

Description: Nylon housing with 1/8" x 1/2" flat edge nylon roller; fits on *L.J. Windows* and others.

G-3013

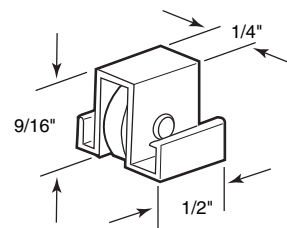

G-3112

Roller Assembly

Contents: 2 roller assemblies.

Description: Nylon housing; 5/8" diameter, flat edge nylon ball bearing roller; fits on *Premier Series 510* windows.

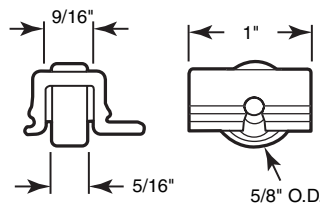

G-3112

G-3012

Roller Assembly

Contents: 2 roller assemblies.

Description: Nylon housing; 1/16" x 3/8" flat edge steel roller; fits on *Daryl*.

You may wish to stock these related parts: **F-2509**.

G-3012

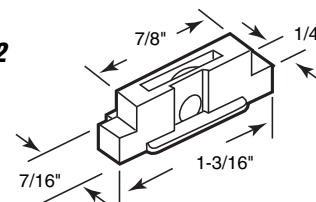

G-3044

Roller Assembly

Contents: 2 roller assemblies.

Description: Nylon housing with flat edge nylon roller.

Call for
Availability

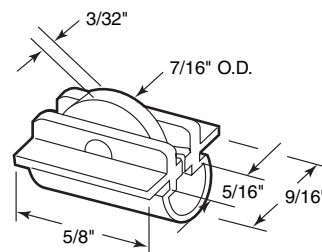

G-3044

G-3064

Roller Assembly

Contents: 2 roller assemblies.

Description: Nylon housing; center groove nylon roller; fits on *Window Master*.

NOTE: Old style diecast housing is no longer available.

Call for
Availability

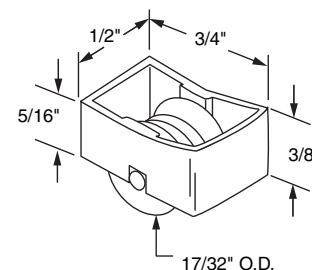

G-3064

G-3065

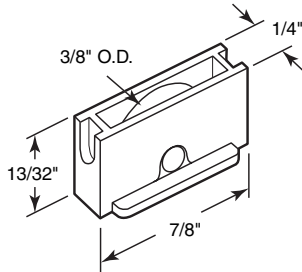
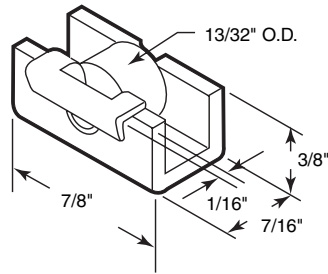

**G-3086
G-3122**

G-3089

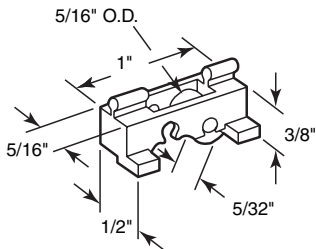
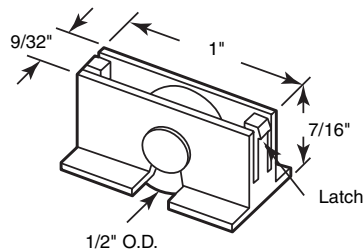

G-3008

G-3010

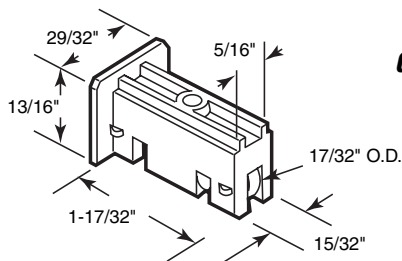
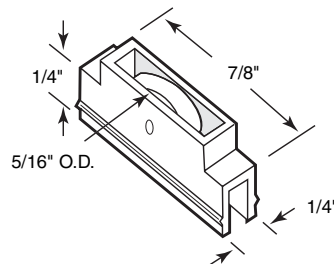

G-3047

G-3065

Roller Assembly

Contents: 2 roller assemblies

Description: Nylon housing; 1/16" guide leg; flat edge nylon roller; fits on *Rolleze* windows.

You may wish to stock these related parts: **F-2553, F-2608, G-3105.**

G-3086 (Nylon roller)

G-3122 (Brass roller)

Roller Assembly

Contents: 2 roller assemblies.

Description: Nylon housing; 3/8" diameter flat edge roller; fits on *Elco, Better-Bilt Aluminum and others.*

G-3089

Roller Assembly

Contents: 2 roller assemblies.

Description: Nylon housing with 1/2" diameter steel roller; fits on *Superlite Series 8000* windows.

G-3008

Roller and Guide Assembly

Contents: 2 roller assemblies.

Description: Adjustable nylon housing; 5/32" x 5/16" flat edge steel roller; 2 position height adjustment; fits on *Olson* and others.

G-3010

Roller Assembly

Contents: 2 roller assemblies.

Description: Nylon housing with 3/32" x 5/16" flat edge steel roller; fits on *Fullview* windows.

You may wish to stock these related parts: **F-2553.**

G-3047

Roller Assembly

Contents: 2 roller assemblies.

Description: Nylon housing with flat edge steel ball bearing roller; fits on *Bee Cee* windows and others.

You may wish to stock these related parts: **F-2548, G-3056, G-3072.**

Call for
Availability

Sliding Window Rollers & Guides

G-3048

Roller Assembly

Contents: 2 roller assemblies.

Description: Nylon housing; 5/8" diameter steel ball bearing roller; center grooved; snap-in design.

G-3048

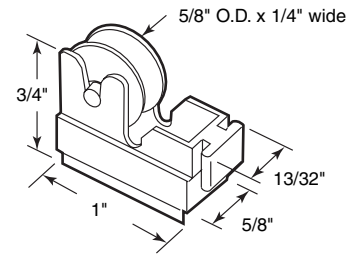

G-3049

Roller Assembly

Contents: 2 roller assemblies.

Description: Nylon housing; flat edge nylon ball bearing roller; designed for *Crossly* windows.

You may wish to stock these related parts: **F-2529, F-2530.**

G-3049

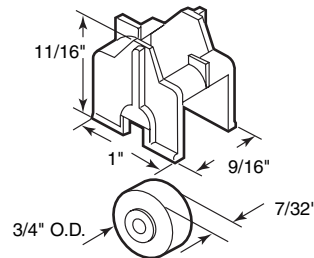

G-3109

Roller Assembly

Contents: 2 roller assemblies.

Description: Nylon housing; 5/16" x 5/16" flat edge steel roller; fits on *Keller Window*.

You may wish to stock these related parts: **F-2541, F-2542, F-2644, G-3060, G-3126.**

G-3109

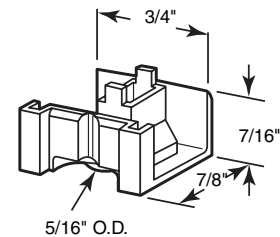

G-3058

Roller Assembly

Contents: 2 roller assemblies.

Description: Nylon housing; flat edge steel roller; fits on *Acorn "Series 2100"* thru *"Series 2300"* old style windows and others.

You may wish to stock these related parts: **F-2645, G-3045, G-3055.**

G-3058

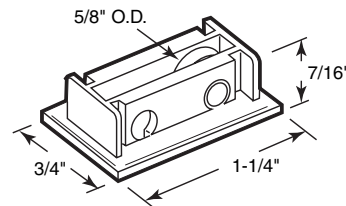

G-3059

Roller Assembly

Contents: 2 roller assemblies.

Description: Nylon housing; flat edge steel roller; fits on *Acorn "Series 2100"* thru *"Series 2300"* new style windows and others.

You may wish to stock these related parts: **F-2645, G-3045, G-3055, G-3058.**

G-3059

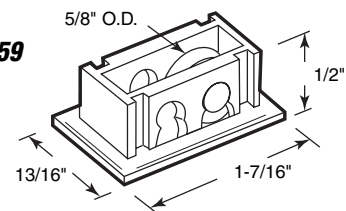

G-3072

Roller Assembly

Contents: 2 roller assemblies.

Description: Adjustable nylon housing; steel ball bearing roller; fits on *Thermo Glide, Bee Cee* and others.

You may wish to stock these related parts: **F-2548, G-3047, G-3056, G-3101.**

G-3072

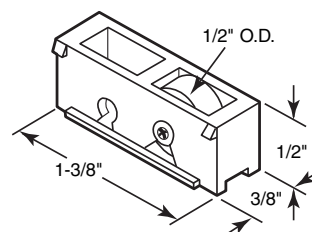

G-3127

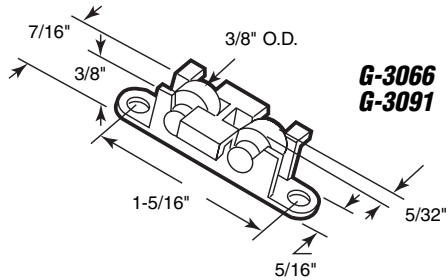
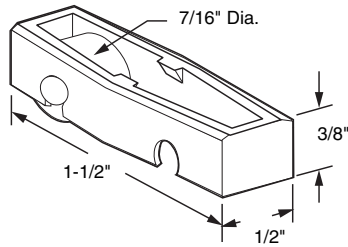

G-3107

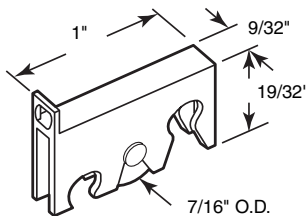
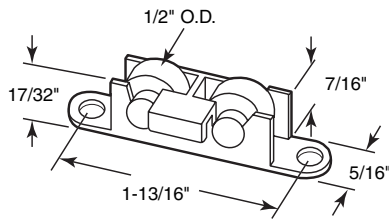

G-3097

G-3043

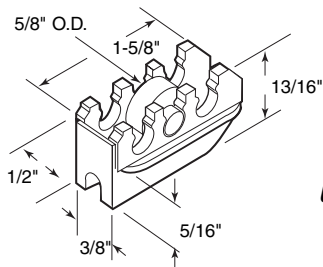
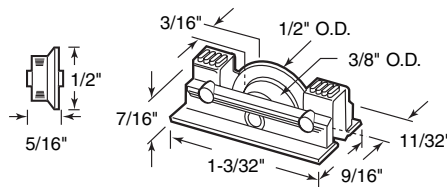

G-3045

G-3127

Roller Assembly

Contents: 2 roller assemblies.

Description: Nylon housing; solid brass rollers; fits on *Capitol Windows 600 Series*.

You may wish to stock these related parts: **F-2529, F-2530.**

G-3066 (Nylon roller)

G-3091 (Brass roller)

Roller Assembly

Contents: 2 roller assemblies.

Description: Nylon housing; flat edge tandem rollers; fits on *House of Aluminum* and others.

G-3107

Roller Assembly

Contents: 2 roller assemblies.

Description: Nylon housing; flat edge tandem nylon rollers.

G-3097

Roller Assembly

Contents: 2 roller assemblies.

Description: Nylon housing; 7/16" diameter steel roller; 3-height adjustment; fits on *Alenco*.

You may wish to stock these related parts: **G-3096, G-3100, G-3103, G-3117, G-3166.**

G-3043

Roller Assembly

Contents: 2 roller assemblies.

Description: Nylon housing; flanged edge nylon roller; used on sliding windows.

Call for Availability

G-3045

Roller Assembly

Contents: 2 roller assemblies.

Description: Plastic housing with flat edge steel roller; fits on *Acorn 2200 Series* windows.

You may wish to stock these related parts: **F-2645, G-3055, G-3058, G-3059.**

Sliding Window Rollers & Guides

G-3046

Roller Assembly

Contents: 2 roller assemblies.

Description: Nylon housing with flat edge steel roller; fits on *Capitol "Series 180"* windows.

You may wish to stock these related parts: **G-3127**.

G-3046

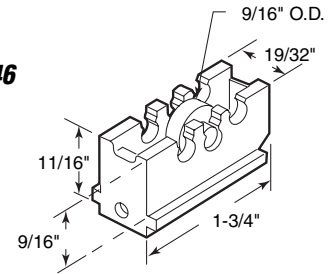

G-3006

Roller Assembly

Contents: 1 roller assembly.

Description: Nylon housing with 5/32" x 7/16" center groove steel roller; 3-position height adjustment; fits on *Glasco* windows.

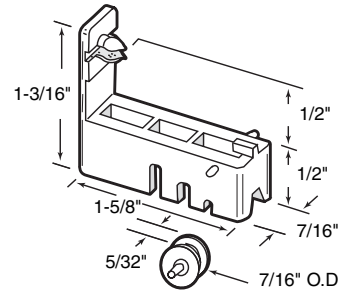

G-3006

G-3007

Roller Assembly

Contents: 1 roller assembly.

Description: Nylon housing; tandem roller design; 5/32" x 7/16" center groove steel rollers; 3 position height adjustment; fits on *Pacific* windows.

You may wish to stock these related parts: **G-3063**, **G-3141**.

Call for Availability

G-3007

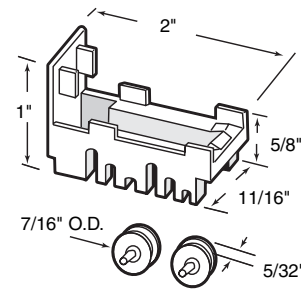

G-3071

Roller Assembly

Contents: 2 roller assemblies.

Description: Nylon housing; dual steel rollers; fits on *Tomrays Tyco 77* dual glazed windows.

You may wish to stock these related parts: **F-2547**.

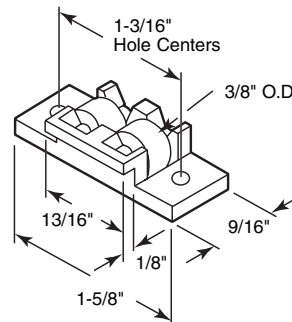

G-3071

G-3119

Roller Assembly

Contents: 2 roller assemblies.

Description: Nylon housing; flat edge brass rollers; used by several window manufacturers.

G-3119

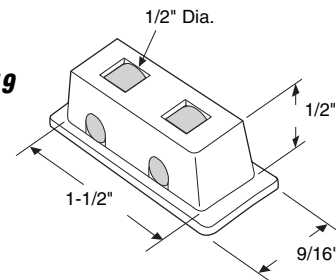

G-3134

Roller Assembly

Contents: 2 roller assemblies.

Description: Nylon housing; flat edge nylon rollers; used by several window manufacturers.

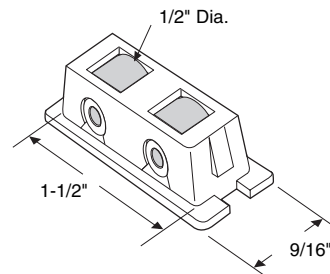

G-3134

G-3136

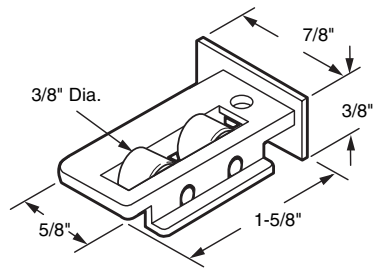

G-3136

Roller Assembly (Left and right)

Contents: 2 roller assemblies.

Description: White nylon housing with twin nylon rollers; brass axles; fits on *Premiere* windows.

You may wish to stock these related parts: **G-3015, G-3060, G-3088, G-3098, G-3122.**

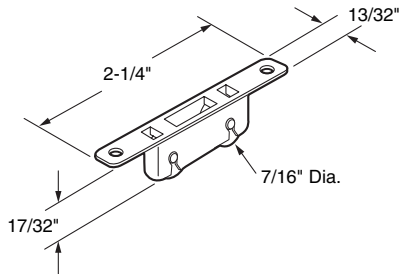

G-3130

G-3130

Roller Assembly

Contents: 2 roller assemblies.

Description: Nylon housing; 7/16" diameter solid brass rollers; used by several window manufacturers.

G-3131

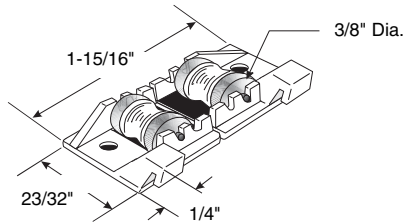

G-3131

Roller Assembly

Contents: 2 roller assemblies.

Description: White nylon housing; brass rollers; fits on *Merzon* windows.

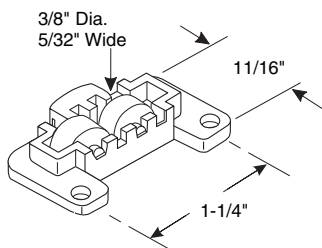

G-3132

G-3132

Roller Assembly

Contents: 2 roller assemblies.

Description: Black nylon housing; brass rollers; steel axles.

G-3159

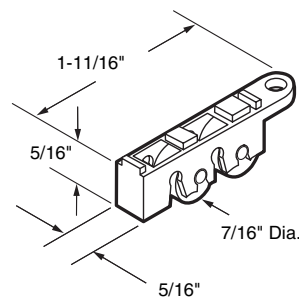

G-3159

Roller Assembly

Contents: 2 roller assemblies.

Description: Adjustable nylon housing; solid brass rollers.

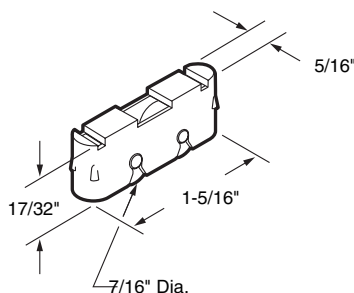

G-3160

G-3160

Roller Assembly

Contents: 2 roller assemblies.

Description: High quality nylon housing; tandem nylon rollers.

G-3118

Roller Assembly

Contents: 2 roller assemblies.

Description: Nylon housing; flat edge brass rollers; fits on *Elco/Century* windows.

You may wish to stock these related parts: **G-3061**, **G-3122**, **G-3135**.

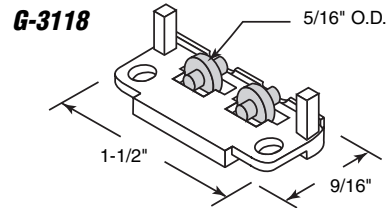

G-3158

Roller Assembly

Contents: 2 roller assemblies.

Description: White nylon housing; flat edge tandem steel rollers; fits on *A.B.C.* windows; dual wheel upgrade to the **G-3036**, improves glide and window performance.

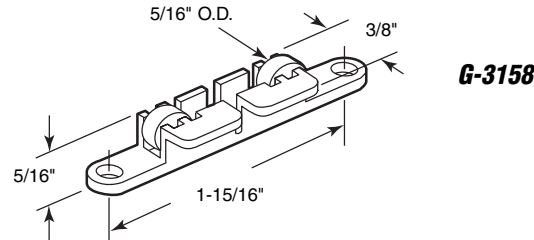

G-3146

Roller Assembly

Contents: 2 roller assemblies.

Description: White nylon housing; nylon rollers; fits by *Milgard* and others.

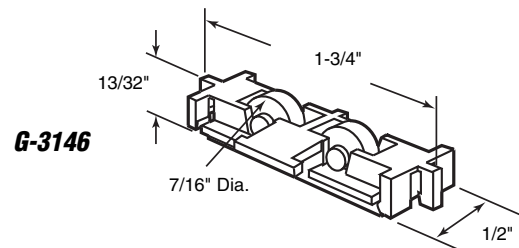

G-3014 (Nylon ball bearing)

G-3133 (Steel ball bearing)

Roller Assembly

Contents: 2 roller assemblies.

Description: Used as a bottom roller on heavy sliding glass windows; adjustable steel housing with 7/32" x 27/32" center grooved roller.

You may wish to stock these related parts: **G-3073**.

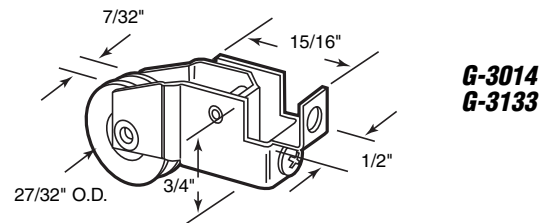

G-3099

Roller Assembly

Contents: 1 roller assembly.

Description: Steel adjustable housing; 13/16" diameter flat edge nylon ball bearing roller; fits on *Likit* windows.

You may wish to stock these related parts: **F-2513**, **F-2514**, **G-3078**, **G-3079**, **G-3080**, **G-3081**, **G-3113**.

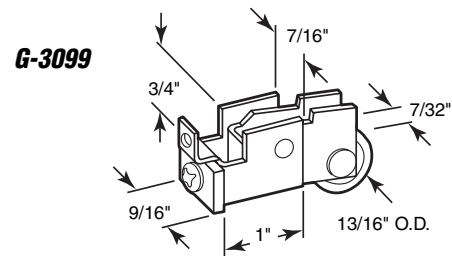

G-3129

Roller Assembly

Contents: 2 roller assemblies.

Description: Nylon housing; 15/32" diameter twin, flat edge, solid brass rollers; stainless steel axles.

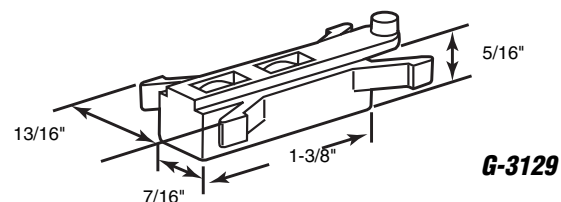

G-3166

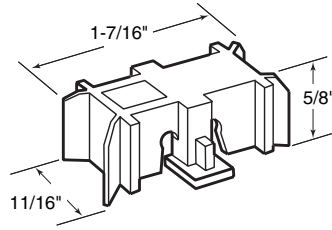

G-3166

Roller Assembly

Contents: 2 roller assemblies.

Description: Adjustable white nylon housing; 1/2" diameter flat edge steel roller; fits on *Alenco*.

You may wish to stock these related parts: **G-3096, G-3097, G-3100, G-3103, G-3117.**

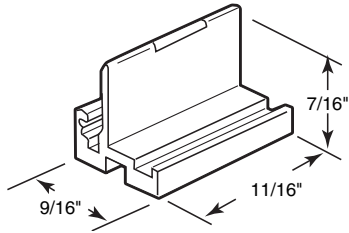

G-3025

G-3025

Top Guide

Contents: 4 guides.

Description: Nylon top guide for *Fullview* windows.

You may wish to stock these related parts: **F-2553, G-3009, G-3010, G-3011, G-3026, G-3039, G-3082.**

Call for Availability

G-3026

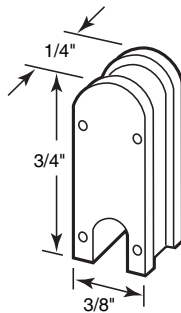

G-3026

Top Guide

Contents: 6 guides.

Description: Nylon top guide and anti-rattler; fits on *Fullview* windows.

You may wish to stock these related parts: **F-2553, G-3009, G-3010, G-3011, G-3039, G-3082.**

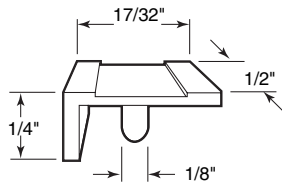

G-3027

G-3027

Top Guide

Contents: 4 guides.

Description: Nylon top guide and anti-rattler; fits on *Hallmark* windows; popular on recreation vehicles.

You may wish to stock these related parts: **F-2510, F-2511, F-2585, F-2586.**

Call for Availability

G-3062

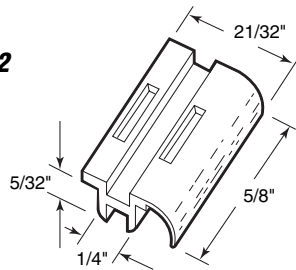

G-3062

Top Guide

Contents: 4 guides.

Description: Nylon top guide fits on *Radco* old style windows; snap-in design.

You may wish to stock these related parts: **G-3028, G-3029, G-3030, G-3031, G-3153.**

Call for Availability

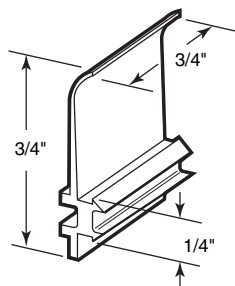

G-3063

G-3063

Top Guide

Contents: 4 guides.

Description: Nylon top guide; fits on *Pacific* old style windows.

You may wish to stock these related parts: **G-3007, G-3141.**

Sliding Window Rollers & Guides

G-3069

Top Guide

Contents: 4 guides.

Description: Black nylon top guide and anti-rattler; popular on mobile homes; fits on *Phillips* windows.

You may wish to stock these related parts: **G-3070**.

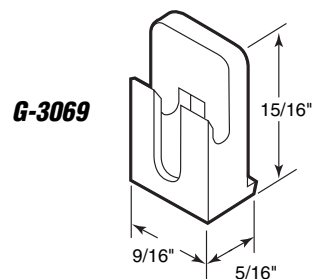

G-3103

Top Guide

Contents: 4 guides.

Description: Nylon top guide for sliding aluminum windows; snap-in design; fits on *Alenco*.

You may wish to stock these related parts: **G-3096, G-3097, G-3100, G-3117**.

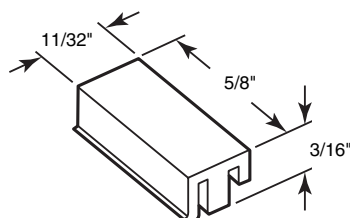

G-3028

Top Guide

Contents: 4 guides.

Description: Plastic top guide; snap-in design; fits on *Radco* windows.

You may wish to stock these related parts: **G-3029, G-3030, G-3031, G-3062, G-3153**.

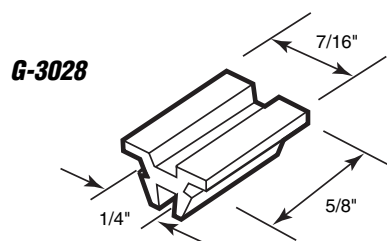

G-3141

Top Guide

Contents: 4 guides.

Description: Gray nylon top guide; snap-in design; fits on *Pacific Window* and others.

You may wish to stock these related parts: **G-3007, G-3063**.

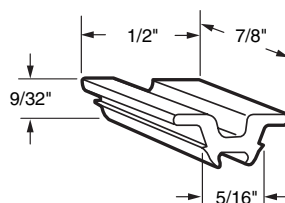

G-3154

Top Guide

Contents: 4 guides.

Description: Nylon top guide; fits on *International* sliding aluminum windows.

You may wish to stock these related parts: **F-2521, G-3000, G-3074, G-3102**.

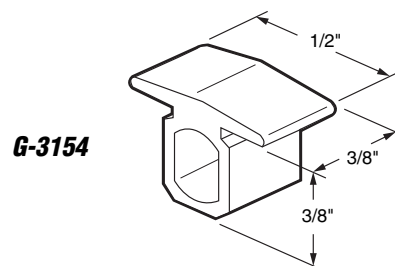

G-3110

Bottom Guide

Contents: 2 guides.

Description: Nylon bottom guide; fits on *Mayfair* windows.

You may wish to stock these related parts: **G-3023, G-3104**.

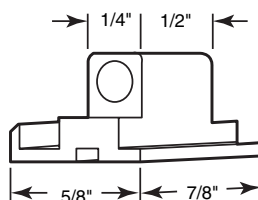

G-3114

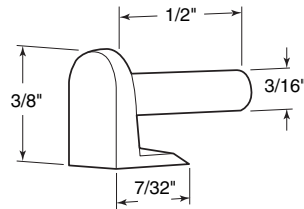

G-3114

Bottom Guide

Contents: 4 guides.

Description: Nylon bottom guide; snap-in design; corner mounted; acts as a glide on sliding aluminum windows.

Call for Availability

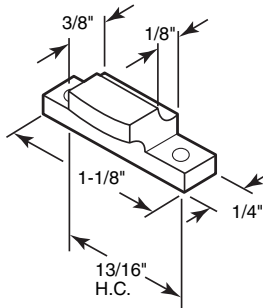

G-3070

G-3070

Bottom Glide

Contents: 4 glides.

Description: Black nylon bottom glide; also serves as a guide; popular on mobile homes; fits on *Phillips* windows.

You may wish to stock these related parts: **F-2623, G-3069, G-3132.**

G-3081

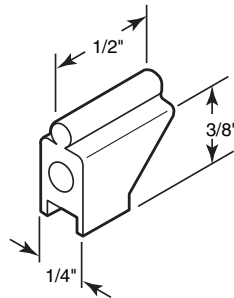

G-3081

Bottom Glide

Contents: 4 glides.

Description: Nylon glide; installs on bottom of window to act as a roller; fits on *Likit* windows.

You may wish to stock these related parts: **F-2513, F-2514, G-3099.**

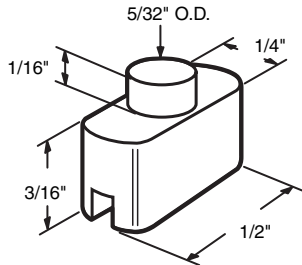

G-3096

G-3096

Bottom Glide

Contents: 4 glides.

Description: Nylon glide snaps into hole in bottom vent rail; fits on *Alenco*.

You may wish to stock these related parts: **G-3097, G-3100, G-3103.**

G-3100

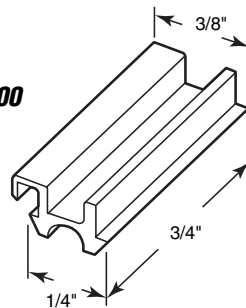

G-3100

Bottom Glide

Contents: 4 glides.

Description: Nylon glide acts as a roller on sliding aluminum windows; fits on *Alenco*.

You may wish to stock these related parts: **G-3103, G-3117.**

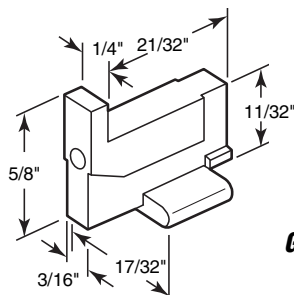

G-3104

G-3104

Bottom Glide

Contents: 2 glides.

Description: Nylon corner and bottom glide act as a roller on sliding aluminum windows; fits on *Mayfair* windows.

You may wish to stock these related parts: **G-3023, G-3110.**

Sliding Window Rollers & Guides

G-3080

Guide

Contents: 4 guides.

Description: Nylon guide; installs on lock side of window; fits on *Likit* windows.

You may wish to stock these related parts: **G-3099**.

G-3115

Guide

Contents: 6 guides.

Description: Nylon guide; snap-in design; used on both top and bottom of window.

G-3029

Guide

Contents: 4 guides.

Description: Plastic snap-in style guide; fits on *Radco* windows.

You may wish to stock these related parts: **G-3153**.

G-3113

Guide

Contents: 4 guides.

Description: Nylon guide; snap-in design; fits on *Likit* windows.

You may wish to stock these related parts: **F-2513, F-2514**.

G-3142

Guide

Contents: 4 guides.

Description: White nylon guide; fits on *Guaranteed Products* and other window manufacturers.

You may wish to stock these related parts: **F-2512, F-2597, F-2647**.

G-3079

Guide and Bumper

Contents: 4 guides.

Description: Nylon guide; installs on lock side of window; fits on *Likit* windows.

You may wish to stock these related parts: **F-2513, F-2514, G-3099**.

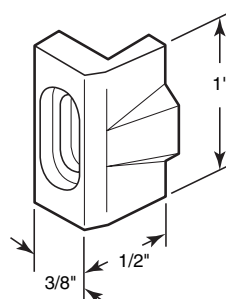
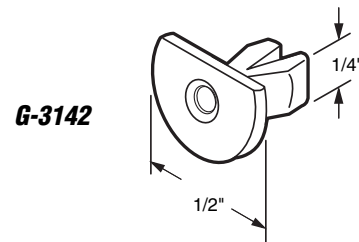
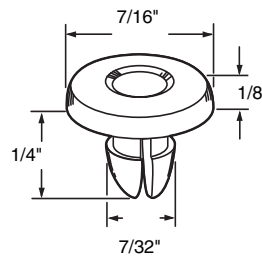
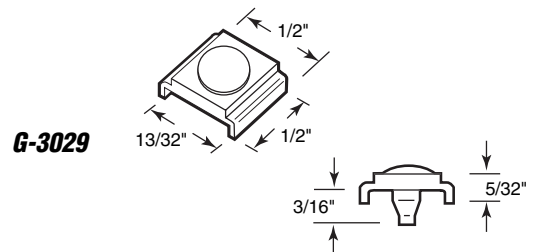
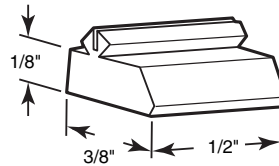
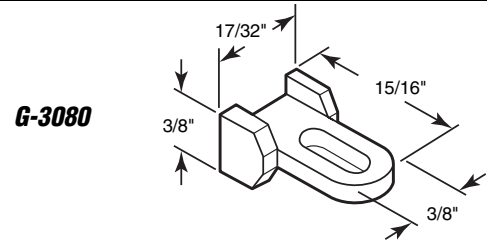

G-3078
G-3078A
G-3078B
G-3078C
G-3078D

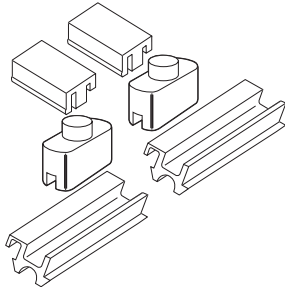
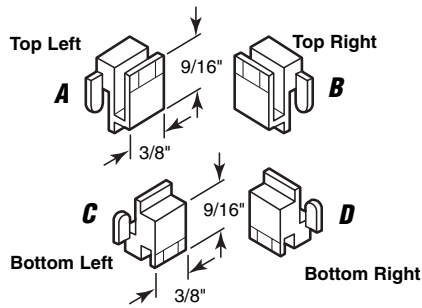

G-3117

G-3022
G-3022B

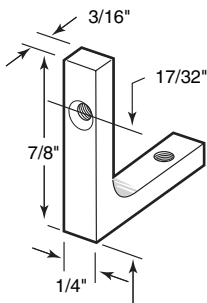
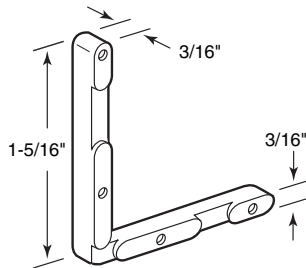

G-3024
G-3024B

G-3057

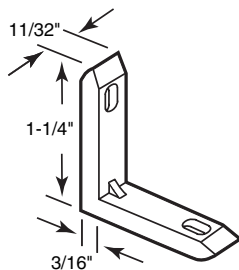
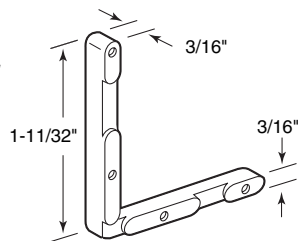

G-3023

G-3078
G-3078A (100/box - top left)
G-3078B (100/box - top right)
G-3078C (100/box - bottom left)
G-3078D (100/box - bottom right)

Corner Guide Set

Contents: 4 guides.

Description: Nylon guides mount on each corner and act as a glide and guide; fits on *Likit* windows.

You may wish to stock these related parts: **F-2513**, **F-2514**, **G-3099**.

G-3117

"Alenco" Repair Kit

Contents: 2 each - top guides, bottom glides (old style) and bottom glides (new style)

Description: Nylon guide and glides; snap-in application; fits to repair *Alenco Series 200* sliding windows, either new or old style.

G-3022 (8 per card)
G-3022B (100 per box)

Corner Insert

Contents: Diecast corners.

Description: Inserts into window frame extrusion to hold frame together; fits on *Bel-Air*.

G-3024 (4 per card)
G-3024B (100 per box)

Corner Insert

Contents: Extruded aluminum corners; no. 5-40 x 5/16" Phillips flat head machine screws.

Description: Inserts into window extrusion to hold frame together; fits on *Rylock* windows.

G-3057

Corner Insert

Contents: 8 corners.

Description: Diecast corner; attaches to window frame by indenting frame with punch; designed to fit "*C*" Sash frame.

G-3023

Corner Insert

Contents: 4 diecast corners.

Description: Inserts into window extrusion to hold frame together; fits on *Mayfair* windows.

Sliding Window Rollers & Guides

G-3155

Corner Insert

Contents: 4 corners.

Description: Zinc diecast corner inserts; fits on *Rylock* and others.

G-3021

Corner Insert & Roller

Contents: 2 corners.

Description: Diecast corner insert with $7/32" \times 5/8"$ nylon rollers; fits on *Trimview*.

Call for
Availability

G-3155

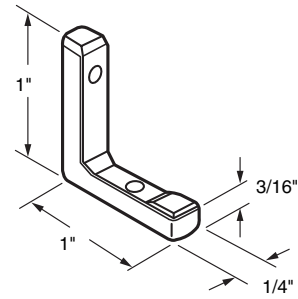

G-3021

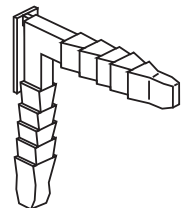
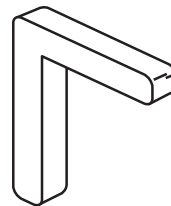
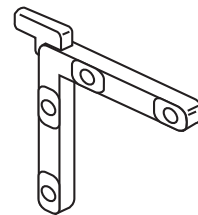
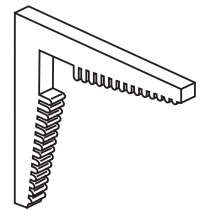
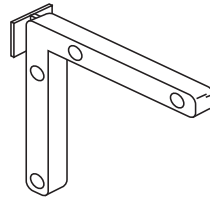
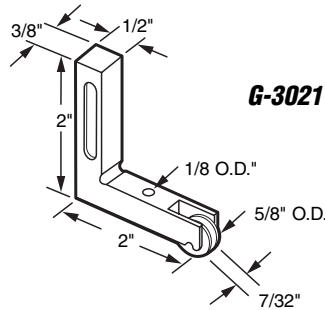

Contact our

Customer Service Department
for a much larger selection
of corner keys and tilt keys!