

Spring Tension Roller

Contents: 2 roller assemblies; installation screws.

Description: Center groove wheel; heat treated, high tension steel spring.

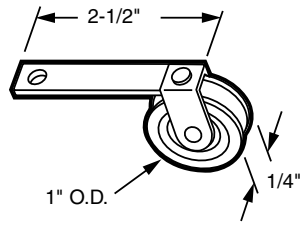

- B-521** (Nylon)
- B-522** (Steel ball bearing)
- B-685** (Nylon ball bearing)

Spring Tension Roller

Contents: 2 roller assemblies; installation screws.

Description: Stainless steel center groove wheel; heat treated, high tension stainless steel spring.

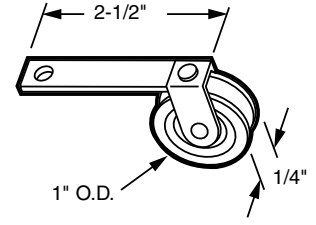

B-753

Spring Tension Roller

Contents: 2 roller assemblies; installation screws.

Description: Center groove wheel; heat treated, high tension steel spring.

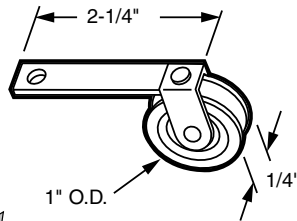

- B-709** (Nylon)
- B-710** (Nylon ball bearing)
- B-711** (Steel ball bearing)



Used primarily in Canada

Spring Tension Roller

Contents: 2 roller assemblies; installation screws.

Description: Center groove wheel; heat treated, high tension steel spring; with angle stops to prevent roller retracting too far into door frame.

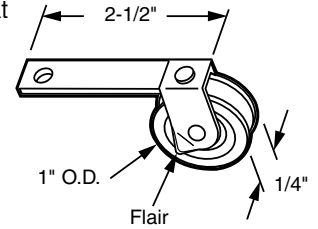

- B-635** (Nylon)
- B-666** (Steel ball bearing)

Spring Tension Roller

Contents: 2 roller assemblies; installation screws.

Description: Center groove wheel; steel bracket with coil spring.

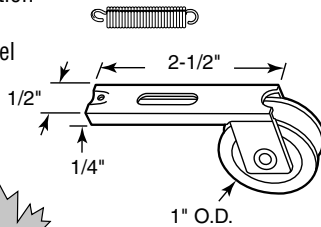

- B-728** (Nylon)
- B-729** (Steel)



Used primarily in Canada

Spring Tension Roller

Contents: 2 roller assemblies; installation screws.

Description: Nylon wheel with center groove; heat treated, high tension steel spring; uses two or three springs to increase tension; fits on doors by **Academy Mfg. Co®**.

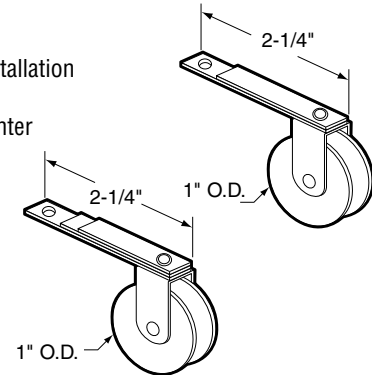

Call For Availability

- B-661** (Double spring)
- B-662** (Triple spring)

Spring Tension Roller

Contents: 1 roller assembly.

Description: Nylon center groove wheel; heat treated, high tension steel spring; used by **Andersen®**.

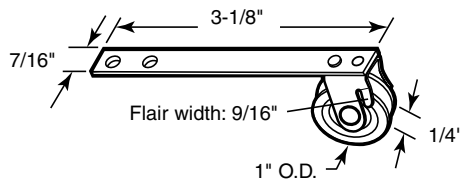

B-744

Spring Tension Roller

Contents: 2 roller assemblies; installation screws.

Description: Center groove wheel; heat treated, high tension steel spring.

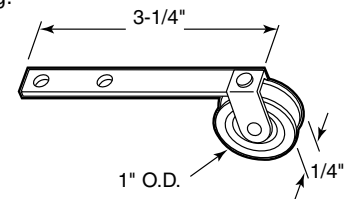

- B-523** (Nylon)
- B-524** (Steel ball bearing)

Spring Tension Roller

Contents: 2 roller assemblies; installation screws.

Description: Stainless steel ball bearing center groove wheel; heat treated, high tension stainless steel spring.

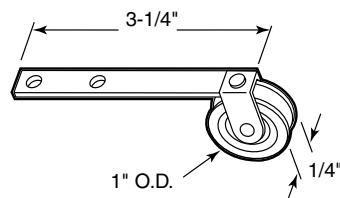

B-754

Spring Tension Roller

Contents: 2 roller assemblies; installation screws.

Description: Center groove wheel; heat treated, high tension steel spring.

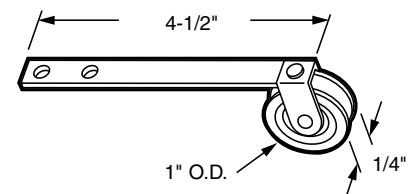

- B-525** (Nylon)
- B-526** (Steel ball bearing)

Spring Tension Roller

Contents: 2 roller assemblies; installation screws.

Description: Nylon ball bearing center groove wheel; heat treated, high tension steel spring.

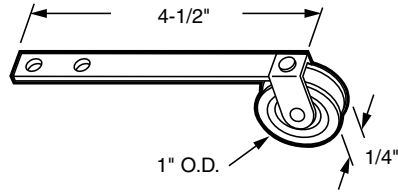

B-743

Spring Tension Roller

Contents: 2 roller assemblies; installation screws.

Description: Center groove wheel; heat treated, high tension steel spring.

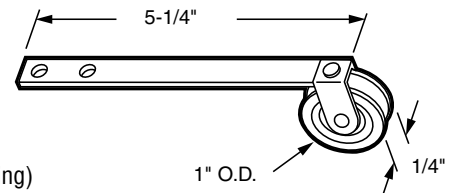

B-527 (Nylon)
B-528 (Steel ball bearing)

Spring Tension Roller

Contents: 2 roller assemblies; installation screws.

Description: Center groove wheel; heat treated, high tension stainless steel spring.

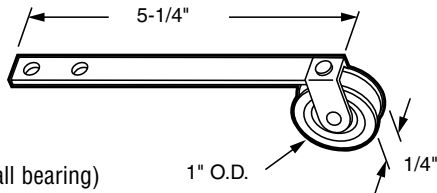

B-775 (Nylon)
B-779 (Stainless steel ball bearing)

Spring Tension Roller

Contents: 2 roller assemblies.

Description: Nylon wheel with center groove; diecast housing, heat treated steel wire loop; with extension spring.

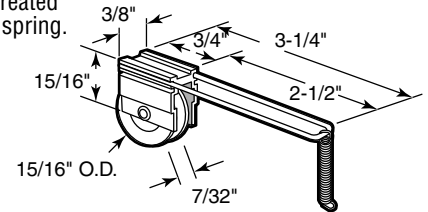

B-519

Spring Tension Roller

Contents: 2 roller assemblies.

Description: Nylon wheel with aluminum housing; heat treated, high tension steel spring; fits on "old style" *Peachtree*® doors.

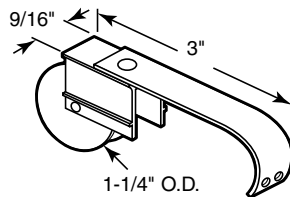

B-659

Spring Tension Roller

Contents: 2 roller assemblies.

Description: Center groove wheel; heat treated, high tension steel spring; fits on doors by *Academy Mfg. Co*®.

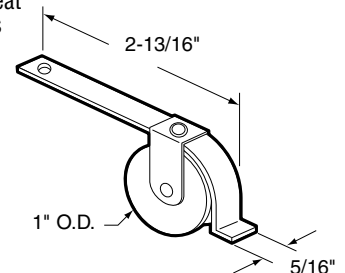

B-681 (Nylon)
B-717 (Steel ball bearing)

Spring Tension Roller

Contents: 1 roller assembly.

Description: Center groove nylon wheel; heat treated tension spring; fits *Andersen*® doors.

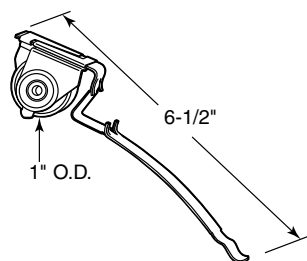

B-745

Spring Tension Roller

Contents: 2 roller assemblies.

Description: Center groove wheel with steel housing; high tension steel spring; fits on *Columbia Uni-fit*® doors.

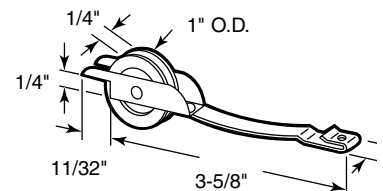

B-649 (Nylon)
B-723 (Nylon ball bearing)
B-704 (Steel ball bearing)

Spring Tension Roller

Contents: 2 roller assemblies; installation screws.

Description: Nylon wheel with center groove; heat treated, high tension steel spring; one piece spring and housing.

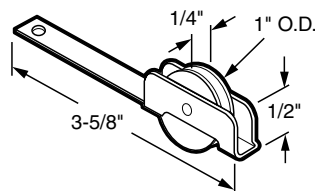

B-577

Spring Tension Roller

Contents: 2 roller assemblies; installation screws.

Description: Center groove wheel; heat treated, high tension steel spring; bent spring design; fits on doors by *Academy Mfg. Co*®.

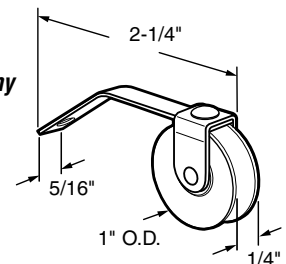

B-609 (Nylon)
B-686 (Nylon ball bearing)
B-576 (Steel ball bearing)

Spring Tension Roller

Contents: 2 roller assemblies; installation screws.

Description: Center groove wheel; heat treated, high tension steel spring.

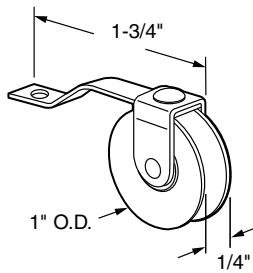

- B-638** (Nylon)
- B-687** (Nylon ball bearing)
- B-639** (Steel ball bearing)

Spring Tension Roller

Contents: 2 roller assemblies; installation screws.

Description: Stainless steel ball bearing center groove wheel; heat treated, high tension stainless steel spring.

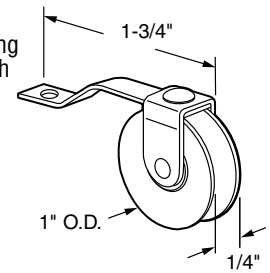

B-756

Spring Tension Roller

Contents: 2 roller assemblies; installation screws.

Description: Steel ball bearing wheel with center groove; heat treated, inverted high tension steel spring.

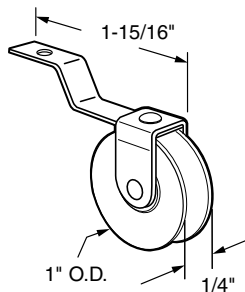

- B-738** (Nylon)
- B-739** (Steel ball bearing)

Spring Tension Roller

Contents: 2 roller assemblies; installation screws.

Description: Nylon wheel with center groove; steel housing; heat treated, high tension steel spring; fits on doors by *Arcadia®*.

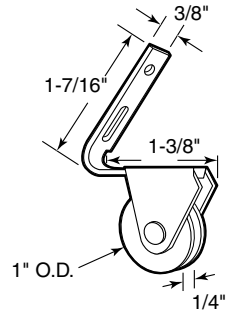

B-655

Spring Tension Roller

Contents: 2 roller assemblies.

Description: Adjustable, center groove wheel; heat treated, high tension steel spring; used by several patio door manufacturers.

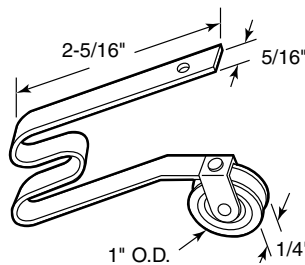

- B-512** (Nylon)
- B-640** (Nylon ball bearing)
- B-513** (Steel ball bearing)
- B-770** (Stainless steel ball bearing)

Spring Tension Roller

Contents: 2 roller assemblies.

Description: Center groove wheel; heat treated, high tension stainless steel spring.

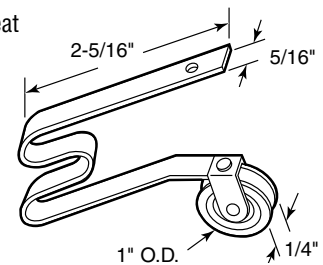

- B-747** (Nylon)
- B-746** (Stainless steel ball bearing)

Spring Tension Roller with Rivet

Contents: 2 roller assemblies.

Description: Adjustable, center groove wheel; heat treated, high tension steel spring; 1/8" locator pin holds roller in fixed position; used by several patio door manufacturers.

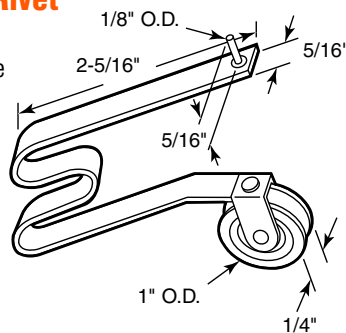

- B-643** (Nylon)
- B-644** (Steel ball bearing)

Spring Tension Roller

Contents: 2 roller assemblies (1 left and 1 right).

Description: Nylon wheel with offset groove; adjustable; heat treated, high tension steel spring.

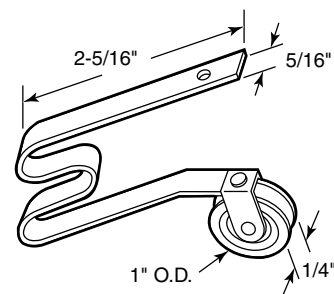
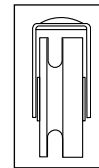

B-632

Spring Tension Roller

Contents: 2 roller assemblies.

Description: Flat nylon wheel; adjustable; heat treated, high tension steel spring.

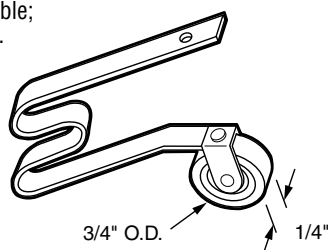
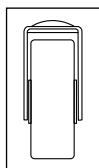

B-750

Spring Tension Roller

Contents: 2 roller assemblies.

Description: Center groove wheel; heat treated, high tension steel spring.

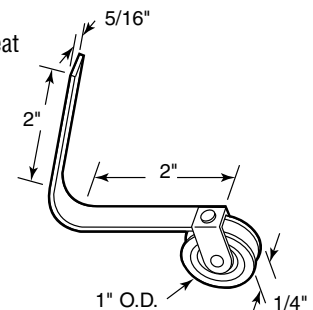

- B-570** (Nylon)
- B-688** (Nylon ball bearing)
- B-571** (Steel ball bearing)

Spring Tension Roller

Contents: 2 roller assemblies.

Description: Center groove wheel; heat treated, high tension steel spring.

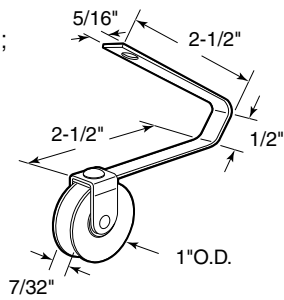

B-698 (Nylon)
B-699 (Steel ball bearing)

Spring Tension Roller

Contents: 2 roller assemblies.

Description: Center groove wheel; heat treated, high tension steel spring.

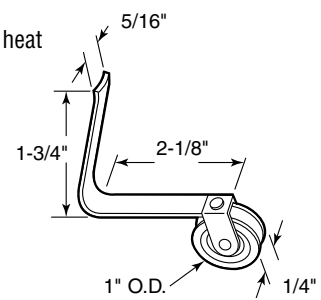

B-504 (Nylon)
B-505 (Steel ball bearing)

Spring Tension Roller

Contents: 2 roller assemblies; installation screws.

Description: Center groove wheel; heat treated, high tension steel spring.

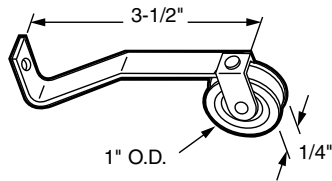

B-572 (Nylon)
B-506 (Steel ball bearing)

Spring Tension Roller

Contents: 2 roller assemblies.

Description: Center groove wheel; heat treated, high tension steel spring.

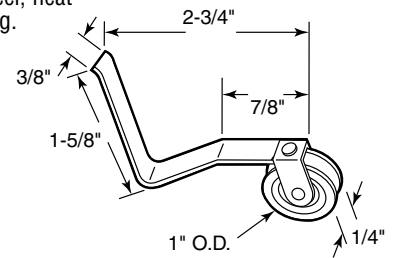

B-509 (Nylon)
B-510 (Steel ball bearing)

Spring Tension Roller

Contents: 2 roller assemblies.

Description: Center groove wheel; heat treated, high tension steel spring.

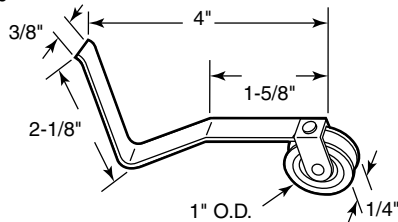

B-507 (Nylon)
B-508 (Steel ball bearing)

Spring Tension Roller

Contents: 2 roller assemblies; installation screws.

Description: Center groove wheel; heat treated, high tension steel spring.

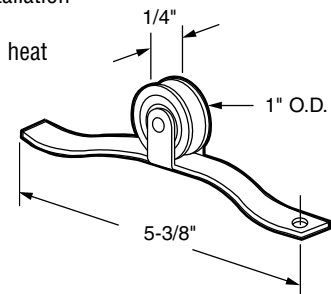

B-574 (Nylon)
B-500 (Steel ball bearing)

Spring Tension Roller

Contents: 2 roller assemblies.

Description: Center groove wheel; heat treated, high tension steel spring.

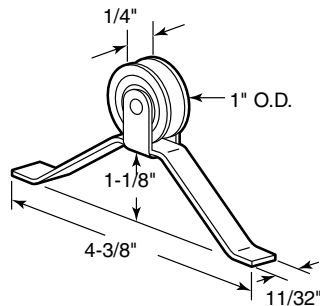

B-501 (Nylon)
B-502 (Steel ball bearing)

Spring Tension Roller

Contents: 2 roller assemblies.

Description: Flat nylon wheel, nylon housing; high tension steel spring; aluminum axle; can be used as a top or bottom roller on **Croft**® doors.

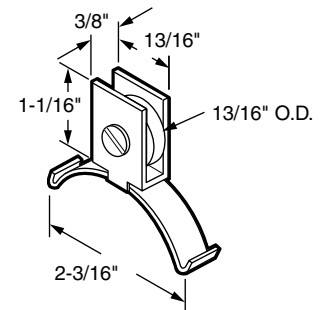

B-625

Spring Tension Roller

Contents: 2 roller assemblies.

Description: Center groove wheel; aluminum housing; heat-treated, high tension steel spring; can be used as a top or bottom roller; fits on **Keller**® doors.

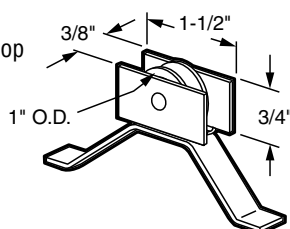

B-503 (Nylon)
B-678 (Steel ball bearing)

Spring Tension Roller

Contents: 2 roller assemblies.

Description: Steel roller housing, nylon ball bearing wheel with center groove; heat treated, high tension steel spring; fits as a top roller on **Better-Bilt**® doors.

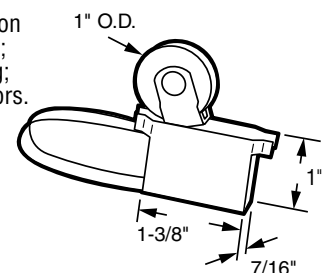

B-611

Spring Tension Roller

Contents: 2 roller assemblies; installation screws.

Description: Extruded aluminum housing, with steel spring; center groove wheel; fits on *International*® series No. 900, 925, 950 doors.

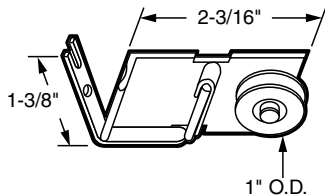

B-517 (Nylon)
B-689 (Steel ball bearing)

Spring Tension Roller

Contents: 2 roller assemblies; installation screws.

Description: Stamped aluminum housing, with steel spring; center groove wheel; fits on *International*® series No. 900, 925, 950 doors; newer style.

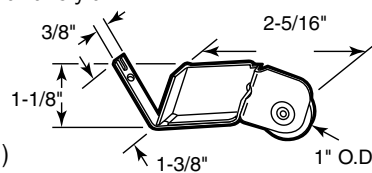

B-634 (Nylon)
B-690 (Steel ball bearing)

Spring Tension Roller

Contents: 2 roller assemblies; installation screws.

Description: Stainless steel housing, with stainless steel spring; adjustable stainless steel ball bearing wheel with center groove.

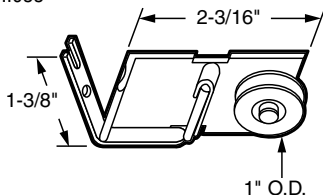

B-752

Spring Tension Roller

Contents: 2 roller assemblies; installation screws.

Description: Center groove wheel; steel housing; heat-treated, high tension steel spring; used as a top and bottom roller.

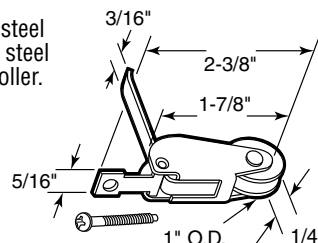

B-518 (Nylon)
B-608 (Steel ball bearing)

Spring Tension Roller

Contents: 2 roller assemblies; installation screws.

Description: Center groove wheel; steel housing; heat-treated, high tension steel spring; used as a top and bottom roller.

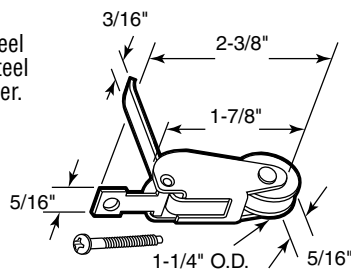

B-654

Spring Tension Roller

Contents: 2 roller assemblies.

Description: Nylon wheel with center groove, steel housing, high tension steel spring.

Call For Availability

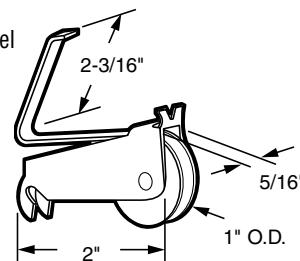

B-637

Spring Tension Roller

Contents: 2 roller assemblies.

Description: Nylon wheel with center groove; steel housing; heat treated, high tension steel spring.

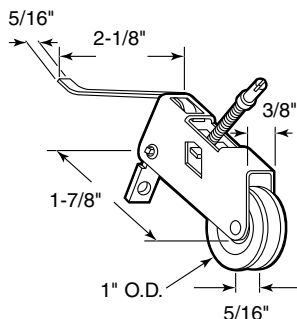

B-516

Spring Tension Roller

Contents: 2 roller assemblies.

Description: Galvanized steel housing, nylon roller, nylon swivel mounting bracket, high tension steel spring fits on doors by *Ador/HiLite*®.

Call For Availability

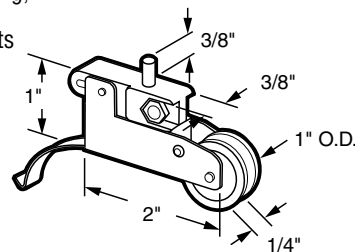

B-618

Spring Tension Roller

Contents: 2 roller assemblies.

Description: Nylon wheel and housing with center groove; heat treated, high tension steel spring.

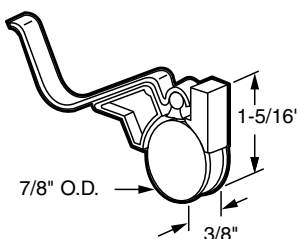

B-511

Spring Tension Roller

Contents: 2 roller assemblies.

Description: Center groove wheel; used as a top and bottom roller.

Related Parts: B-569

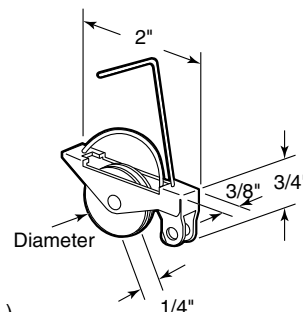

B-541 (Nylon - 1" O.D.)
B-515 (Nylon - 1-1/4" O.D.)
B-610 (Steel ball bearing - 1" O.D.)
B-714 (Steel ball bearing - 1-1/4" O.D.)

Spring Tension Roller

Contents: 2 roller assemblies.

Description: Corrosion resistant stainless steel housing and spring; center groove wheel; used as a top and bottom roller.

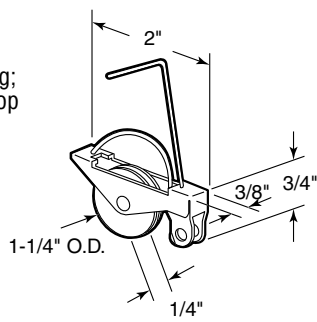

B-736

Spring Tension Roller

Contents: 2 roller assemblies.

Description: Center groove nylon wheel; steel housing; heat treated, high tension steel flat spring; used as top and bottom roller.

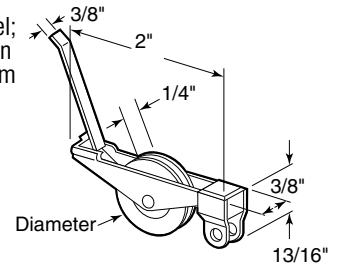

B-514 (1" O.D.)

B-636 (1-1/4" O.D.)

Roller Assembly

Contents: 1 roller assembly; installation screws.

Description: Aluminum housing; center groove wheel; spring loaded aluminum sleeve with adjustment screw.

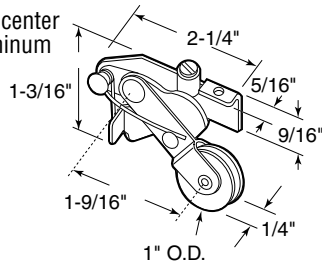

B-641 (Nylon)

B-720 (Nylon ball bearing)

B-679 (Steel ball bearing)

Roller Assembly

Contents: 2 roller assemblies.

Description: Diecast housing; nylon center groove wheel; this roller is used with B-712 corner.



Used primarily in Canada

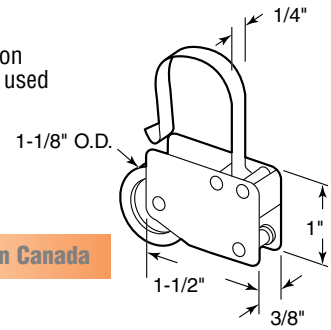

B-713

Roller Assembly

Contents: 2 roller assemblies.

Description: Adjustable screen door roller assembly; steel ball bearing roller.

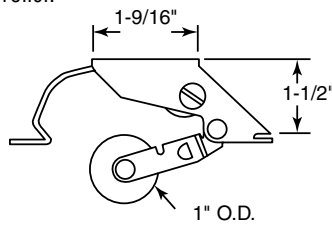

B-786

Roller Assembly

Contents: 2 roller assemblies.

Description: Steel housing; center grooved wheel; spring loaded; fits on doors made by *Metal Industries*®.

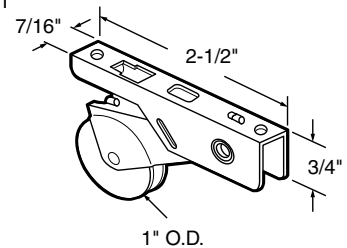

B-781 (Nylon)

B-782 (Steel ball bearing)

Roller Assembly

Contents: 2 roller assemblies.

Description: Stainless steel housing; center grooved wheel; spring loaded; fits on doors made by *Metal Industries*®.

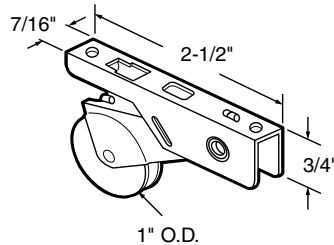

B-664 (Nylon)

B-665 (Stainless steel ball bearing)

Roller Assembly

Contents: 2 roller assemblies.

Description: Spring loaded, steel housing with top adjusting screw; fits on doors made by *Bay-Mills*® and other door manufacturers.

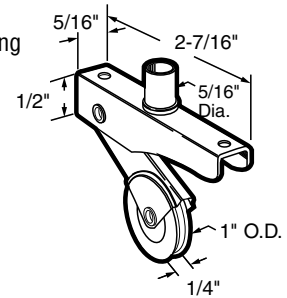

B-701 (Nylon)

B-702 (Steel)

Roller Assembly

Contents: 2 roller assemblies.

Description: Spring loaded, steel housing with top adjusting screw; fits on doors made by *Bay-Mills*® and others.

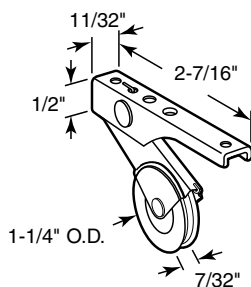

B-740 (Steel)

B-741 (Stainless steel)

Riser Block

Contents: 2 roller assemblies; installation screws.

Description: Sliding screen door riser block used to shim sliding screen door roller housings; works with B-664, B-665, B-701, B-702, B-740, and B-741.

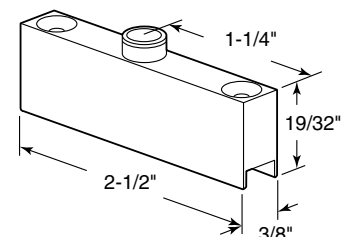

B-742 (Black)

Roller Assembly

Contents: 2 roller assemblies; installation screws.

Description: Adjustable, nylon housing; center groove wheel; fits on doors by **Peachtree®**; this roller fits the same door as B-656 (steel housing).

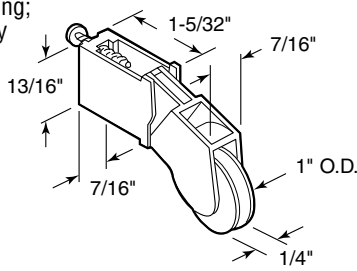

B-645 (Nylon ball bearing)
B-683 (Steel ball bearing)

Roller Assembly

Contents: 2 roller assemblies; installation screws.

Description: Adjustable steel housing; center groove wheel; fits on doors by **Peachtree®**; this roller fits the same door as B-645 (nylon housing).

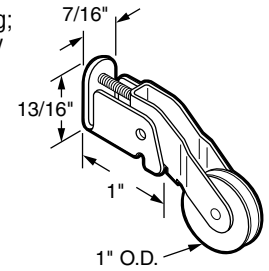

B-721 (Nylon ball bearing)
B-656 (Steel ball bearing)

Roller Assembly

Contents: 2 roller assemblies.

Description: Nylon housing; center groove wheel; with adjustable aluminum yoke; fits on doors by **Jim Walters®**.

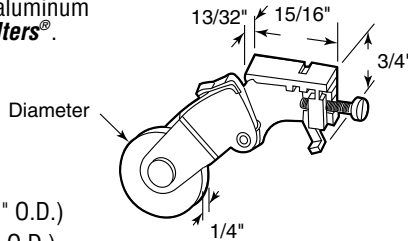

B-647 (Nylon - 15/16" O.D.)
B-722 (Nylon ball bearing - 1" O.D.)
B-682 (Steel ball bearing - 1" O.D.)

Roller Assembly

Contents: 2 roller assemblies.

Description: Nylon housing with center groove nylon wheel; steel spring.

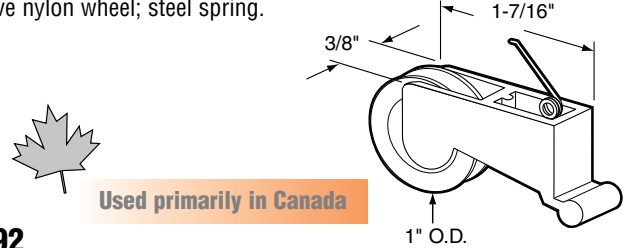

B-692

Roller Assembly

Contents: 2 roller assemblies.

Description: Center groove wheel; steel housing; adjustable tension.

Call For Availability

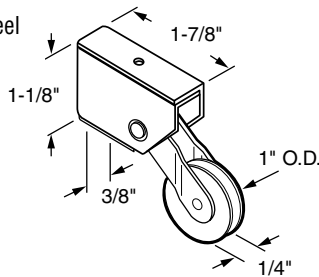

B-734 (Nylon)
B-735 (Steel ball bearing)

Roller Assembly

Contents: 2 roller assemblies.

Description: Extruded aluminum housing, nylon wheel with narrow center groove; with adjusting screw; fits on **Miller®** screen doors.

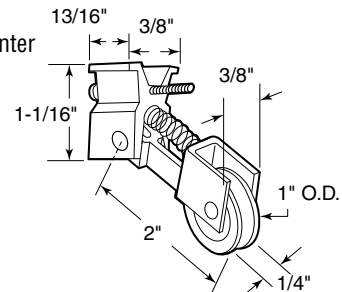

B-586

Roller Assembly

Contents: 1 roller assembly.

Description: Extruded aluminum housing with adjustment screw; nylon yoke; center groove wheel.

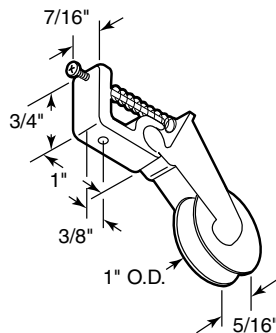

B-582 (Nylon)
B-733 (Steel ball bearing)

Roller Assembly

Contents: 2 roller assemblies, 1 left and 1 right.

Description: Steel ball bearing wheel; adjustable die cast mounting bracket with stamped steel housing.

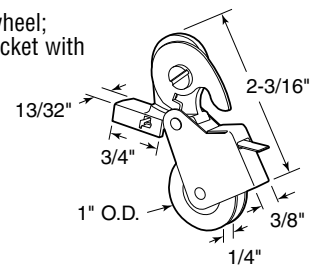

B-663

Roller Assembly

Contents: 2 roller assemblies.

Description: Nylon housing; with center grooved nylon wheel; fits on **Ozark®** and **Chrysler®** doors.

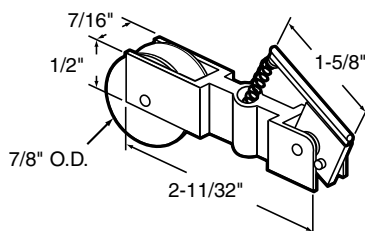

B-694

Roller Assembly

Contents: 2 roller assemblies, 1 left and 1 right.

Description: Nylon housing with nylon wheel; spring loaded; 1 left and 1 right hand roller; used on **Howard®** screen doors.

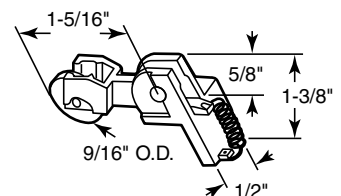

B-584

Roller Assembly

Contents: 2 roller assemblies; installation screws.

Description: Aluminum housing with stainless steel spring; nylon wheel with center groove; built-in screw adjustment feature; used by many door manufacturers.

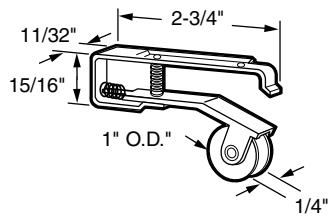

B-578

Roller Assembly

Contents: 2 roller assemblies.

Description: Nylon wheel with center groove; nylon guide roller; heat treated, high tension steel flat spring; fits as a top roller on *Arcadia*® screen doors.

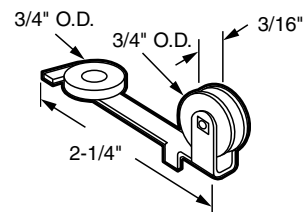

B-520

Roller Assembly

Contents: 2 roller assemblies.

Description: Screen door roller assembly; fits *Baltimore Thermal*® doors.

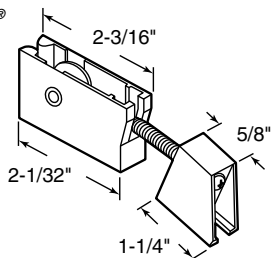

B-785

Roller Assembly

Contents: 2 roller assemblies.

Description: Extruded aluminum bracket with nylon wheel and housing, center groove wheel, spring activated.

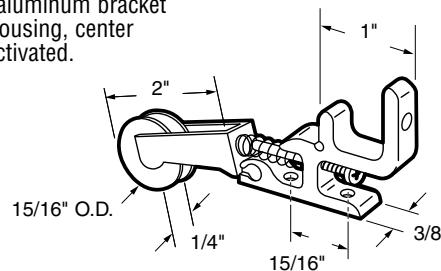

B-583

Roller Assembly

Contents: 2 roller assemblies.

Description: Steel housing with nylon wheel; spring activated; fits on doors by *Crossly*®.

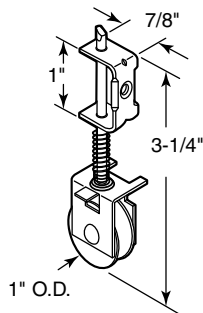

B-588

Roller Assembly

Contents: 2 roller assemblies, 1 left and 1 right.

Description: Extruded aluminum housing; steel ball bearing roller; fits *Kawneer*® doors; used in top position.

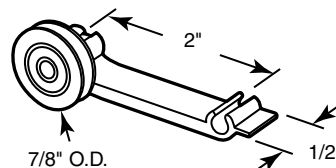

B-788

Roller Assembly

Contents: 2 roller assemblies, 1 left and 1 right.

Description: Extruded aluminum housing; steel ball bearing roller; heat treated, high tension steel spring; fits *Kawneer*® doors; used in bottom position.

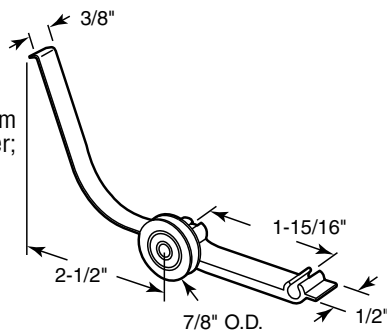

B-789

Tension Spring

Contents: 2 springs.

Description: Top mounted heat treated, high tension steel spring with nylon glide button.

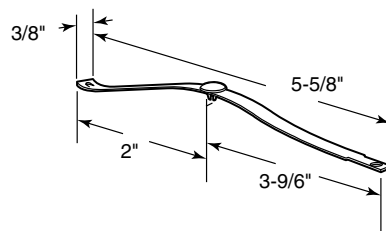

B-703

Tension Spring

Contents: 2 springs.

Description: Heat treated high tension steel spring; used as a top tension guide; fits *Andersen*® doors.

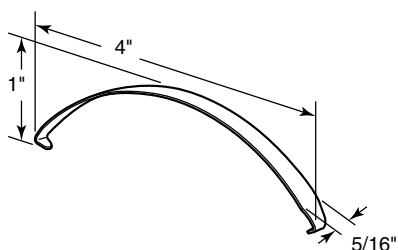

B-803

Roller Assembly

Contents: 2 roller assemblies; installation screws.

Description: Aluminum frame with nylon inner housing; center grooved wheel.

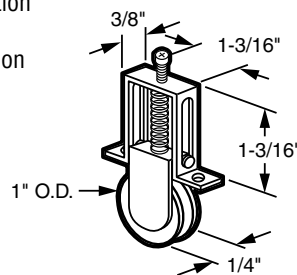

B-530 (Nylon)

B-718 (Nylon ball bearing)

B-617 (Steel ball bearing)

Roller Assembly

Contents: 2 roller assemblies.

Description: Nylon main frame assembly; nylon inner housing with center groove wheel.

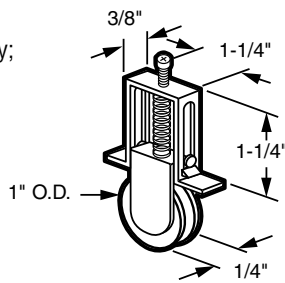

- B-575** (Nylon)
- B-719** (Nylon ball bearing)
- B-631** (Steel ball bearing)
- B-755** (Stainless steel ball bearing)

Roller Assembly

Contents: 2 roller assemblies; installation screws.

Description: Nylon housing and yoke; center groove wheel; used as top and bottom roller on **Academy Uni-fit**® doors.

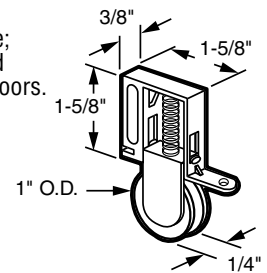

- B-529** (Nylon)
- B-624** (Steel ball bearing)

Roller Assembly

Contents: 2 roller assemblies; installation screws.

Description: Center groove wheel; nylon housing with adjustable nylon yoke; has thicker housing than B-691.

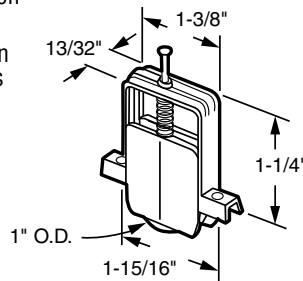

- B-646** (Nylon ball bearing)
- B-737** (Steel ball bearing)

Roller Assembly

Contents: 2 roller assemblies; installation screws.

Description: Center groove wheel; has thinner nylon housing than B-646; fits on doors by **Columbia**®.

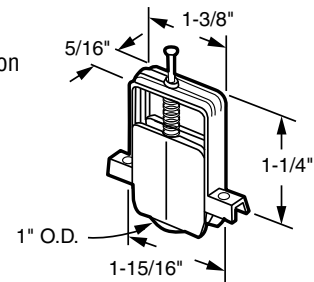

- B-691** (Nylon)
- B-695** (Steel ball bearing)
- B-812** (Stainless steel)

Roller Assembly

Contents: 2 roller assemblies; installation screws.

Description: Nylon outer housing, aluminum inner housing with nylon center grooved wheel; fits **Andersen**® doors.

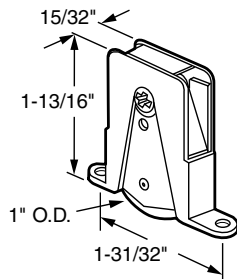

B-684

Roller Assembly

Contents: 2 roller assemblies; installation screws.

Description: Nylon outer housing; stainless steel inner housing with center grooved stainless steel ball bearing wheel; fits **Andersen**® doors.

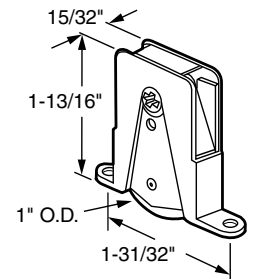

B-751

Roller Assembly

Contents: 1 roller assembly.

Description: Plastic assembly with aluminum inner housing; nylon roller; attached adjustment screw; fits **Andersen**® doors.

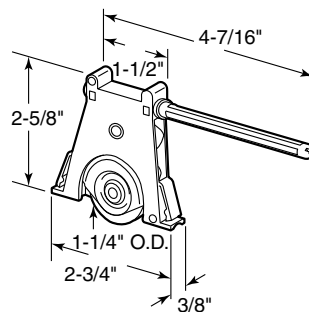

B-715

Roller Assembly

Contents: 2 roller assemblies.

Description: Center groove nylon roller; nylon housing.

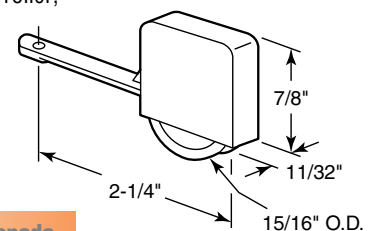

B-730

Used primarily in Canada

Roller Assembly

Contents: 2 roller assemblies; installation screws.

Description: Nylon housing with center groove, steel ball bearing wheel; bottom mount.

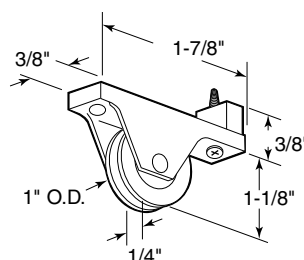

B-547

Roller Assembly

Contents: 2 roller assemblies.

Description: Adjustable, steel housing; center groove wheel; spring loaded; fits on doors made by **Pacesetter**®.

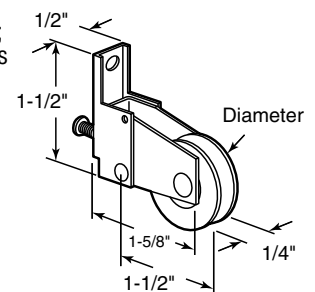

- B-605** (Nylon ball bearing - 1" O.D.)
- B-669** (Steel ball bearing - 7/8" O.D.)

Roller Assembly

Contents: 2 roller assemblies.

Description: Steel housing with nylon wheel; spring loaded; fits on doors made by *Peachtree*[®].

Call For Availability

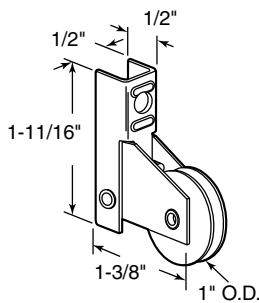

B-606

Roller Assembly

Contents: 2 roller assemblies.

Description: Nylon ball bearing roller; adjustable steel housing; spring loaded; fits on doors made by *Moss*[®].

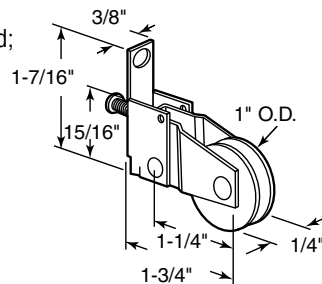

B-777

Roller Assembly

Contents: 2 roller assemblies.

Description: Nylon ball bearing roller; adjustable steel housing; spring loaded.

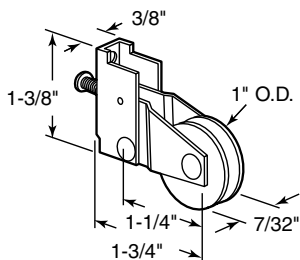

B-772

Roller Assembly

Contents: 2 roller assemblies.

Description: Adjustable steel housing assembly; center grooved wheel; used by several door manufacturers.

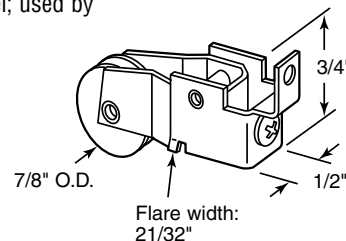

B-793 (Nylon)
B-794 (Steel ball bearing)

Roller Assembly

Contents: 2 roller assemblies.

Description: Stamped steel housing; grooved wheel; fits *Columbia*[®] doors.

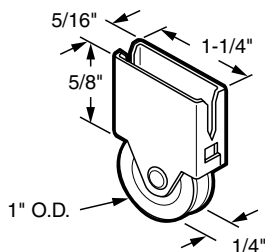

B-652 (Nylon)
B-696 (Steel ball bearing)

Roller Assembly

Contents: 2 roller assemblies.

Description: Steel housing; center groove wheel; bottom roller on *Empire*[®] and *Better-Bilt*[®] adjustable sliding screen doors.

Related Part: B-611

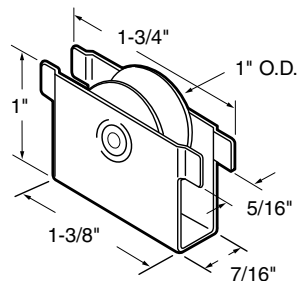

B-579 (Nylon)
B-612 (Steel ball bearing)

Roller Assembly

Contents: 2 roller assemblies.

Description: Wide groove nylon wheel; zinc plated steel housing; brass axle; fits *Pella*[®] screen doors.

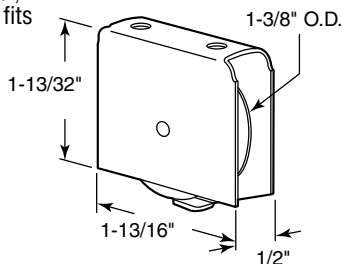

B-783

Roller Assembly

Contents: 2 roller assemblies; installation screws.

Description: Nylon housing; side adjust feature; center groove wheel; used on vinyl sliding screen doors.

Call For Availability

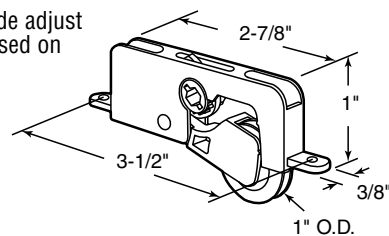

B-758 (Nylon)
B-759 (Steel ball bearing)
B-760 (Stainless steel ball bearing)

Roller Assembly

Contents: 2 roller assemblies; installation screws.

Description: Top hung; nylon housing with oval edge nylon ball bearing wheel; built-in guide; fits on *HiLite*[®] doors.

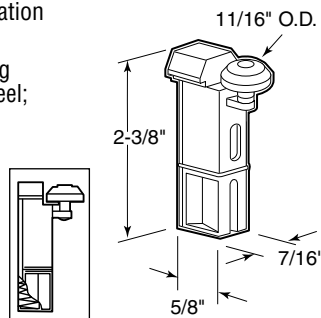

B-543

Roller Assembly

Contents: 2 roller assemblies; installation screws.

Description: Bottom mount; nylon bracket with flat edge, nylon wheel; fits on *HiLite*[®] doors.

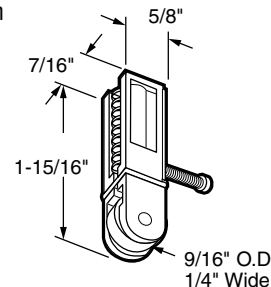

B-544

Roller Assembly Kit

Contents: 2 top roller assemblies; 2 bottom roller assemblies; installation screws.

Description: Top roller: Nylon housing with oval edge nylon ball bearing wheel; built-in guide; fits on *HiLite*® doors.

Bottom roller: Nylon bracket with flat edge, nylon wheel; fits on *HiLite*® doors.

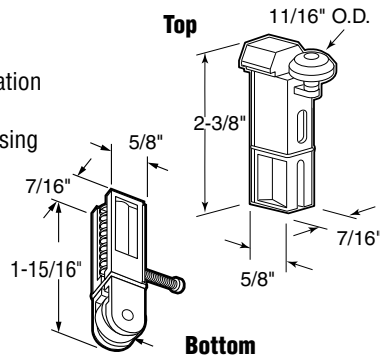

B-778

Roller Assembly

Contents: 2 roller assemblies; installation screws.

Description: Nylon housing and flat nylon wheel; with steel spring; fits on *Weathershield*® doors.

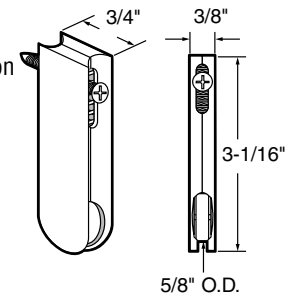

B-668

Roller Assembly

Contents: 2 roller assemblies; installation screws.

Description: Top hung; steel bracket with oval edge nylon ball bearing wheel; with nylon guide; fits on *Ador / HiLite*® doors.

Call For Availability

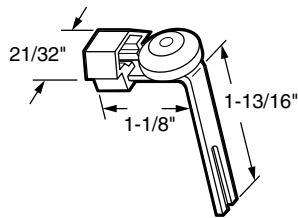

B-619

Roller Assembly

Contents: 2 roller assemblies.

Description: Bottom mount; heat treated, high tension steel spring; nylon guide; fits on *Ador / HiLite*® doors.

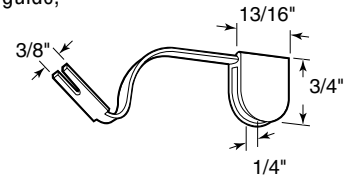

B-620

Roller Assembly

Contents: 2 roller assemblies; installation screws.

Description: Top hung; steel bracket with cone-shaped nylon wheel; fits on *HiLite*® old style doors.

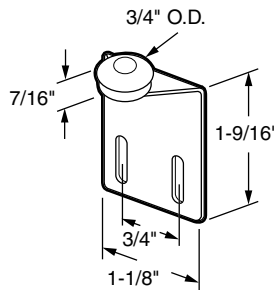

B-542

Roller Assembly

Contents: 2 roller assemblies; installation screws.

Description: Top hung; aluminum bracket, steel ball bearing wheel with center groove; fits on *Fullview*® doors.

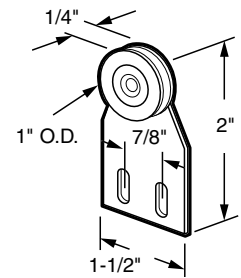

B-537

Roller Assembly

Contents: 2 roller assemblies; installation screws.

Description: Top hung; 1/16" offset aluminum bracket, steel ball bearing wheel with center groove.

Call For Availability

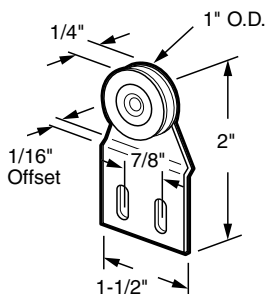

B-538

Roller Assembly

Contents: 2 roller assemblies; installation screws.

Description: Top hung; 1/4" offset steel bracket, steel ball bearing wheel with wide center groove; fits on *Ador "Z"* doors.

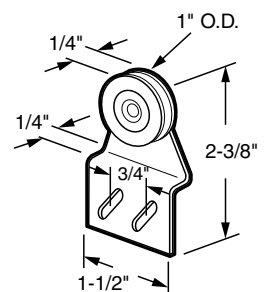

B-539

Roller Assembly

Contents: 2 roller assemblies; installation screws.

Description: Top hung; aluminum bracket, center groove wheel; new style without tabs on bracket will replace old style; fits on *Cupples*® doors.

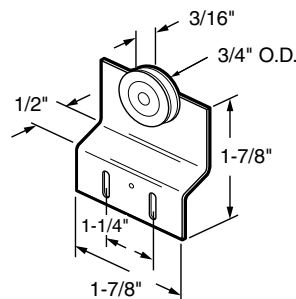
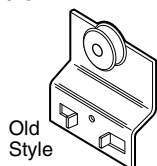

B-540

Roller Assembly

Contents: 2 roller assemblies; installation screws.

Description: Aluminum bracket, oval edge nylon wheel 3/16" wide; top mount; fits on *Croft*® old style doors.

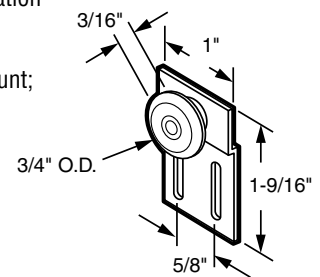

B-627

Roller Assembly

Contents: 2 roller assemblies.

Description: Top hung; adjustable; steel bracket with center groove wheel; fits on **Ador**® doors.

Call For Availability

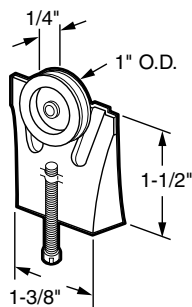

B-535 (Nylon)

B-536 (Steel ball bearing)

Roller Assembly

Contents: 2 roller assemblies; installation screws.

Description: Top hung; steel bracket with oval edge nylon ball bearing wheel; fits on **Arcadia**® & **Saurenman**® old style steel and aluminum screen doors.

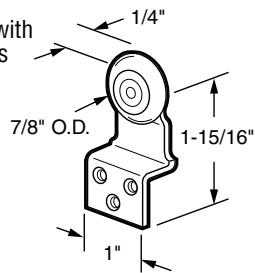

B-531

Roller Assembly

Contents: 2 roller assemblies; installation screws.

Description: Top hung; steel bracket with center groove steel ball bearing wheel; fits on **Premier**® doors.

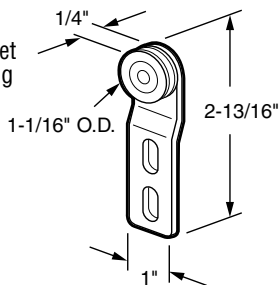

B-533

Roller Assembly

Contents: 2 roller assemblies; installation screws.

Description: Top hung; steel bracket with center groove steel ball bearing wheel; fits on **Hollyview**® doors.

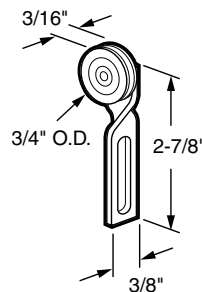

B-534

Roller Assembly

Contents: 2 roller assemblies, 1 left and 1 right; installation screws.

Description: Top hung; steel bracket with oval edge nylon ball bearing wheel; used on old style wood sliding screen doors.

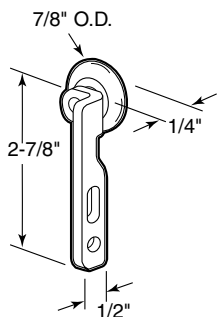

B-532

Roller Assembly

Contents: 2 roller assemblies; installation screws.

Description: Extruded aluminum housing with nylon wheel; narrow center groove with one side of the wheel having a larger diameter than the other.

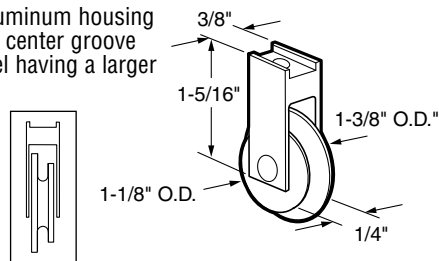

B-587

Roller Assembly

Contents: 2 roller assemblies; installation screws.

Description: Extruded aluminum housing with top support plate; nylon wheel with narrow center groove; fits on **Daryl PM**® doors.

Call For Availability

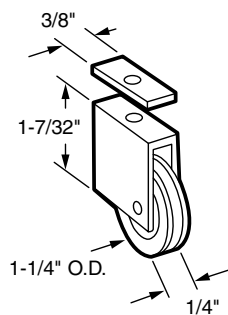

B-580

Roller Assembly

Contents: 2 roller assemblies; installation screws.

Description: Extruded aluminum housing; nylon wheel with narrow center groove; fits on **Daryl PM**® doors.

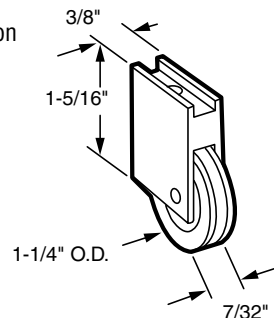

B-581

Roller Assembly

Contents: 2 roller assemblies, 1 left and 1 right.

Description: Nylon housing with 1/8" thick, 3/4" diameter flat nylon wheel; fits on **Howard**® doors.

Call For Availability

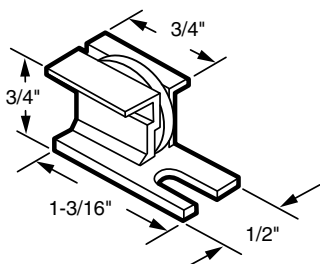

B-585

Corner Insert

Contents: 2 corner inserts.

Description: Diecast corner with adjustment screw; fits **Monar**® screen doors; fits B-713 roller.



Used primarily in Canada

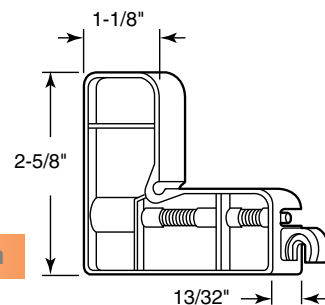

B-712

Corner Insert

Contents: 2 corner inserts.

Description: Diecast plain finish; for 45° miter cut door design; used by many door manufacturers.

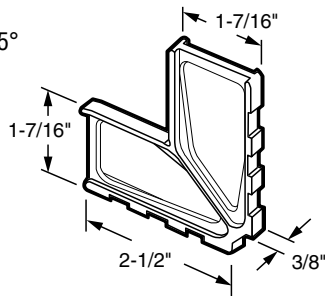

Call For Availability

B-642

Corner Insert

Contents: 2 corner inserts.

Description: Diecast corner with adjustment screw; for 45° miter cut door design; fits B-515 style rollers used by many door manufacturers.

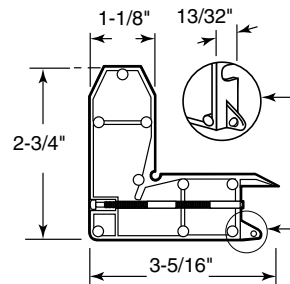

B-569

Corner Insert

Contents: 1 corner insert.

Description: Screen door corner assembly with center groove nylon roller; adjustable tension; used by **Acorn Industries®**.

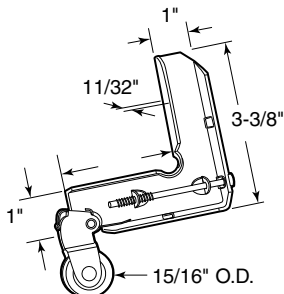

B-693

Corner Insert

Contents: 1 corner insert.

Description: Stamped aluminum corner; center groove wheel; adjusting screw; fits on doors by **Jim Walters®**.

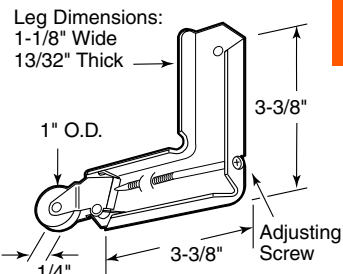

- B-604** (Nylon wheel)
- B-724** (Nylon ball bearing wheel)
- B-725** (Steel ball bearing wheel)
- B-748** (Stainless steel ball bearing wheel)

Corner Insert

Contents: 1 corner insert.

Description: Stamped steel corner housing; zinc plated finish; with center groove wheel; spring activated; adjusting screw; fits on doors by **Metal Industries®**.

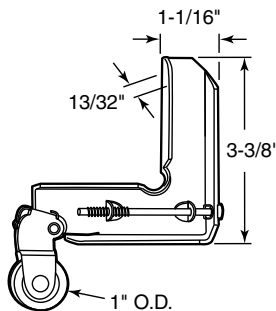

- B-607** (Nylon wheel)
- B-726** (Nylon ball bearing wheel)
- B-727** (Steel ball bearing wheel)
- B-749** (Stainless steel ball bearing wheel)

Corner Insert

Contents: 1 corner insert.

Description: Stamped steel corner housing with nylon wheel. Note: B-657 contains 1 pair (left & right).

Call For Availability

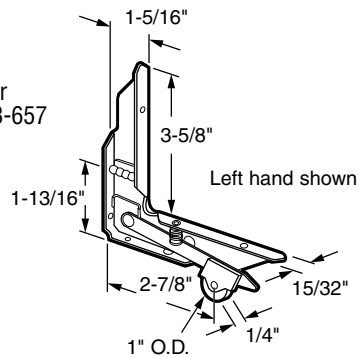

- B-650** (Left hand)
- B-651** (Right hand)
- B-657** (Left and Right hand)

Corner Insert

Contents: 1 corner insert.

Description: Stamped aluminum corner; center groove wheel; adjusting screw; used on old **Jim Walters®** screen doors.

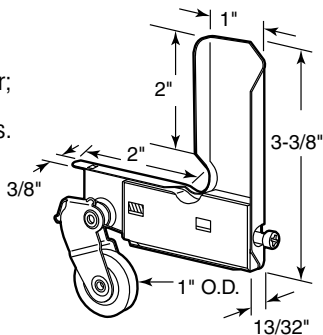

B-773

Corner Insert

Contents: 1 corner insert.

Description: Stamped steel corner housing; zinc plated finish; with center groove nylon wheel; spring activated; adjusting screw.

Call For Availability

Used primarily in Canada

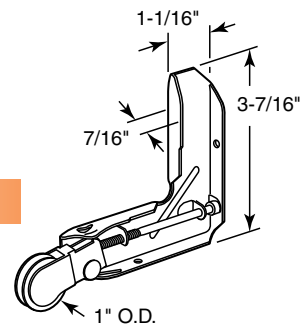

B-808

Roller Assortment

Contents: 3 pairs of rollers.

Description: 2 each 7/8" flat edge nylon ball bearing wheels with threaded inner race and machine screws; 2 each 15/16" flat edge nylon wheels with steel; rivet; 2 each 1-1/8" flat edge nylon wheels with aluminum rivet.

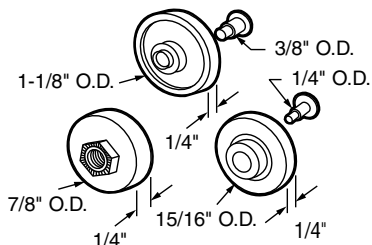

B-622

Roller Assembly

Contents: 2 rollers; with fasteners.

Description: Threaded hex hub; 3/4" flat nylon ball bearing wheel; fits **Croft®** and **Keller®** doors.

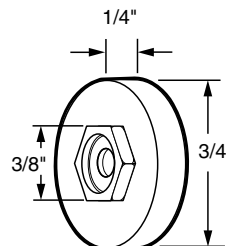

B-629

Roller

Contents: 2 rollers.

Description: Flat edge nylon roller; used by several screen door manufacturers.

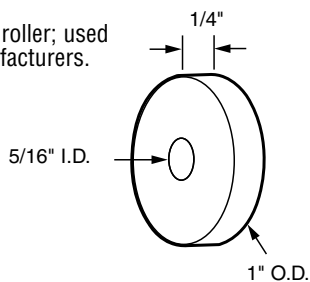

B-792

Roller Assembly

Contents: 2 rollers; 2 rivets.

Description: Center groove wheel; aluminum rivet; repair wheel for many screen door roller assemblies.

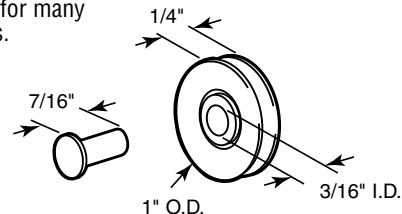

B-706 (Nylon)

B-697 (Steel ball bearing)

Roller

Contents: 2 rollers.

Description: Nylon ball bearing wheel with center groove; repair part for many screen door roller assemblies.

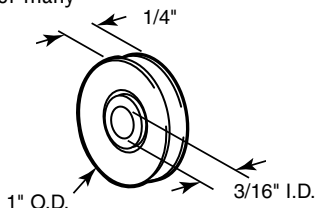

B-707

Roller Assembly

Contents: 2 rollers; with fasteners.

Description: Steel ball bearing roller; with 1/4 inch hole; center grooved; 1/4-20 x 3/4 inch carriage bolt with nut; used by many door manufacturers.

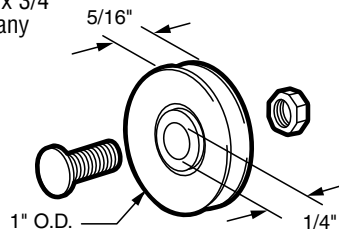

B-548

Roller Assembly

Contents: 2 rollers; with fasteners.

Description: Ball bearing roller with 1/4 inch hole; center grooved; 1/4-20 x 3/4 inch carriage bolt with nut; used by many door manufacturers.

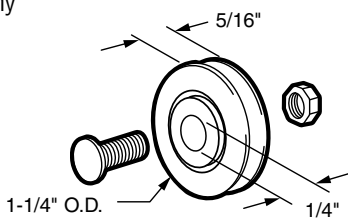

B-550 (Nylon ball bearing)

B-549 (Steel ball bearing)

Roller Assembly

Contents: 2 rollers; with fasteners.

Description: Nylon wheel with narrow center groove; 8-32 x 3/8 inch machine screw with binder post nut; fits on *Air Control*® doors.

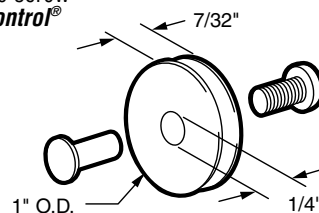

B-551

Roller

Contents: 2 rollers.

Description: Nylon center groove wheel; used by many door manufacturers.

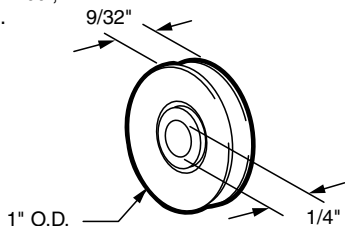

B-552

Roller Assembly

Contents: 2 rollers; with fasteners.

Description: Nylon wheel with nylon bushing; 1/4-20 x 3/4 inch carriage bolt with nut.

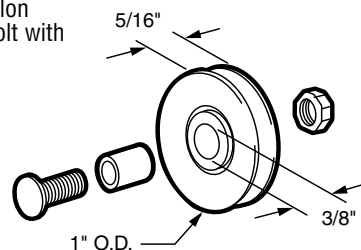

B-553

Roller Assembly

Contents: 2 rollers; with fasteners.

Description: Nylon wheel with narrow offset groove; steel bushing; 1/4-20 x 3/4 inch carriage bolt with nut.

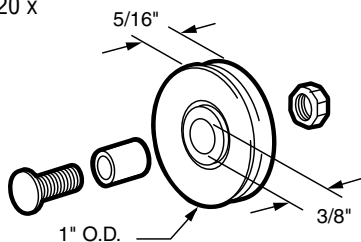
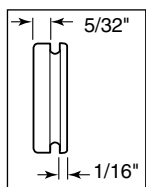

B-554

Roller Assembly

Contents: 2 rollers; with fasteners.

Description: Nylon wheel; nylon bushing; 1/4-20 x 3/4 inch carriage bolt with nut.

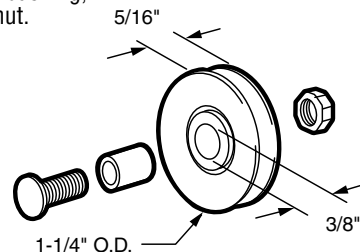

B-555

Roller Assembly

Contents: 2 rollers; with fasteners.

Description: Nylon wheel with narrow offset groove; steel bushing; 1/4-20 x 3/4" carriage bolt with nut.

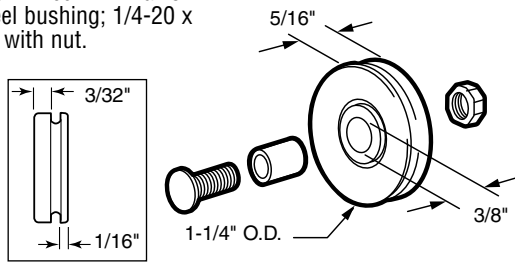

B-556

Roller Assembly

Contents: 2 rollers; with fasteners.

Description: Nylon wheel; nylon spacer washers; 8-32 threaded steel bushing and screw.

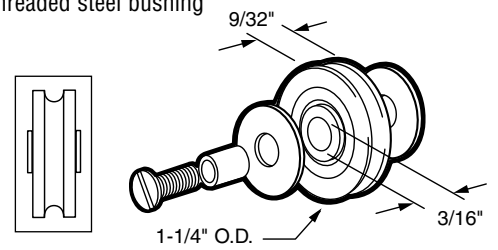

B-557

Roller Assembly

Contents: 2 rollers; with fasteners.

Description: Nylon wheel; nylon spacer washers; 8-32 threaded steel bushing and screw.

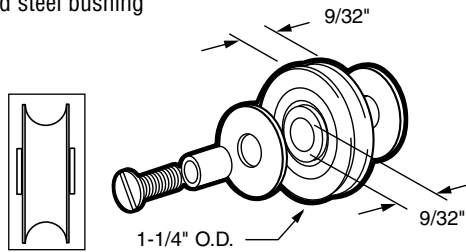

B-558

Roller Assembly

Contents: 2 roller assemblies; with fasteners, nylon spacers.

Description: Nylon wheel with wide center groove; spring loaded (not included); nylon spacer washers; threaded insert and screw.

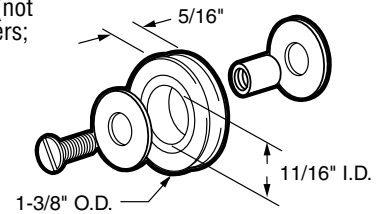

B-559

Roller Assembly

Contents: 2 rollers; with fasteners.

Description: Nylon wheel with aluminum 8-32 internally threaded hub; wide center groove; fits on *Arcadia*® doors.

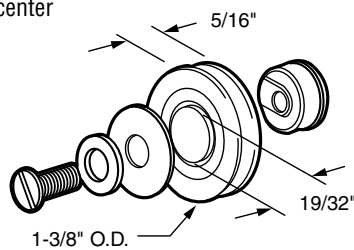

B-560

Roller

Contents: 2 rollers.

Description: Nylon wheel; with center groove; bottom mount.

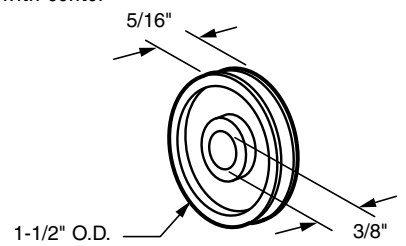

B-653

Top Guide

Contents: 4 guides.

Description: Nylon guide and anti-rattle device; used by many door manufacturers.

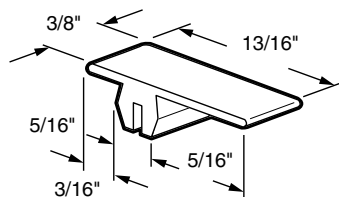

B-562

Top Guide

Contents: 4 guides; with fasteners.

Description: Plastic guide; with attaching screw; fits on *Mayfair*® doors.

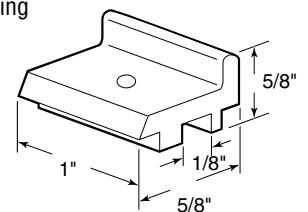

B-563

Top Guide

Contents: 2 guides.

Description: Plastic guide and anti-rattle device; used by many door manufacturers.

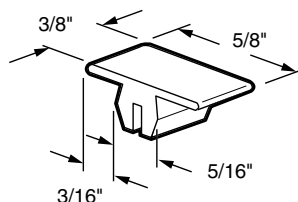

B-564

Top Guide

Contents: 4 guides.

Description: Vinyl guide; fits on screen doors as a top guide and anti-rattle device.

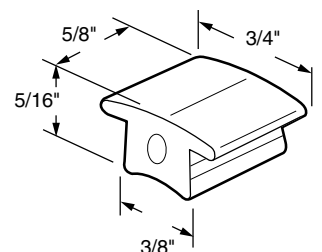

B-633