

**Pull** (Aluminum)

**Contents:** 1 outside pull; installation screws.

**Description:** Anodized aluminum pull; surface mount; used by many manufacturers.

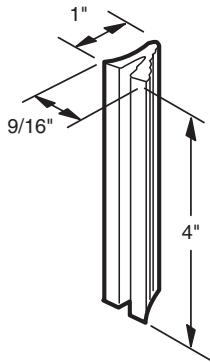

**A-116** (Anodized Aluminum)

**Finger Pull**

**Contents:** 4 pulls.

**Description:** Plated, stamped steel construction.

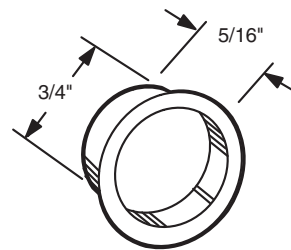

**A-149** (Nickel Plated)

**Screen Shield** (Plastic)

**Contents:** 1 inside and outside panel.

**Description:** Black plastic; protects area around screen door handle; easy, snap together installation; no tools required; works well with most sliding screen door handle assemblies.

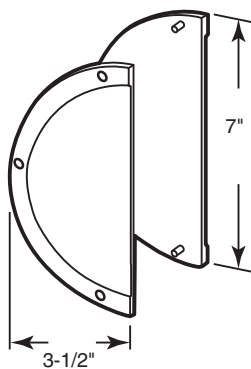

**A-141** (Black)

**Latch Strike** (Plastic)

**Contents:** 1 latch strike; installation screws.

**Description:** Adjustable, used by many patio door manufacturers.

Call For Availability

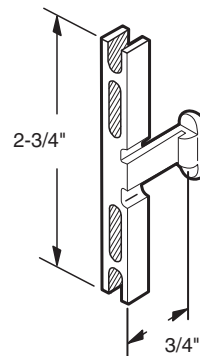

**A-169** (White)

**Strike & Guide Kit**

**Contents:** 1 metal strike, 1 diecast strike, 2 adjustment screws with bushings, 2 top door guides.

**Description:** Sliding screen door keeper, guide and adjustment kit; 2 keeper options repairs most screen doors; adjustment screws and bushings used on most screen doors, top guides fit most screen door channels.

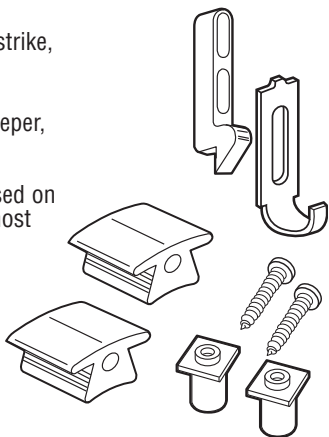

**A-236**

**Latch Strike**

**Contents:** 2 strikes; installation screws.

**Description:** Stamped steel; used by many door manufacturers.

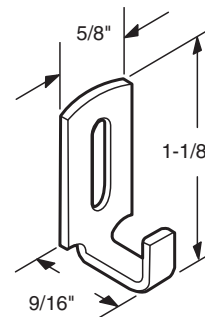

**A-125**

**Latch Strike**

**Contents:** 2 strikes; installation screws.

**Description:** Stamped steel strike; used by *Columbia*® doors.

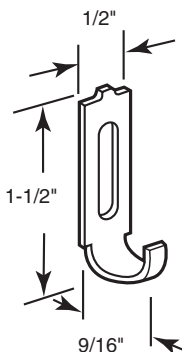

**A-163**

**Latch Strike**

**Contents:** 2 strikes; installation screws.

**Description:** Stamped steel strike; used by *Academy*® screen doors.

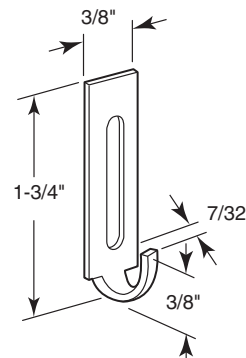

**A-217**

### Latch Strike

**Contents:** 2 strikes; installation screws.

**Description:** Heavy duty; stamped steel, zinc plated strike, extended vertical height adjustment slot.

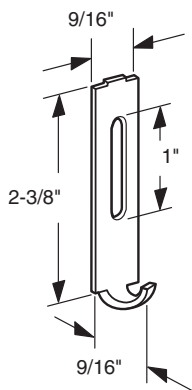

**A-159**

### Latch Strike & Guide

**Contents:** 2 strikes, 2 top guides, installation screws.

**Description:** Narrow bodied screen door strike, stamped steel, zinc plated, black vinyl top guides; fits on *Columbia*<sup>®</sup>.

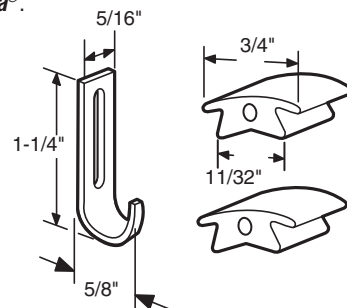

**A-174**

### Latch Strike

**Contents:** 2 strikes; installation screws.

**Description:** Stamped steel strike; adjustable, used by many screen door manufacturers.

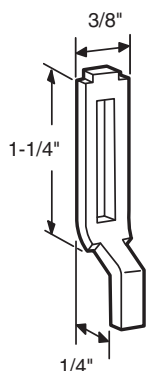

**A-148**

### Latch Strike & Guide

**Contents:** 2 strikes, 2 top guides, installation screws.

**Description:** Stamped steel strike; black vinyl top guides; repair part for A-165, sliding screen door latch and pull.

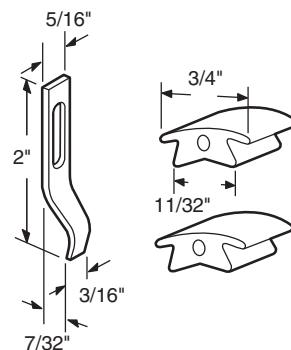

**A-166**

### Latch Strike

**Contents:** 2 strikes; installation screws.

**Description:** Zinc-plated steel; vertical adjustment slot; used by several screen door manufacturers.

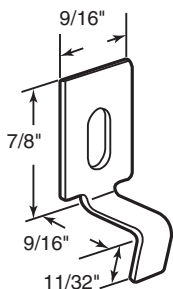

**A-235**

### Latch Strike (Diecast)

**Contents:** 2 strikes; installation screws.

**Description:** Diecast; adjustable; used by many patio door manufacturers.

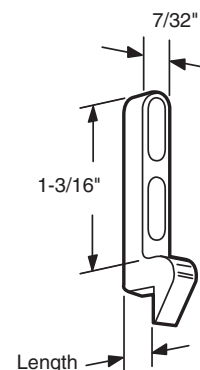

**A-126** (3/16")

**A-127** (1/4")

**A-128** (5/16")

### Latch Strike (Diecast)

**Contents:** 2 strikes; installation screws.

**Description:** Diecast; adjustable; used by many patio door manufacturers.

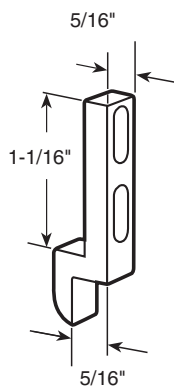

**A-246**

### Latch Strike (Diecast)

**Contents:** 2 strikes; installation screws.

**Description:** Diecast; tapered nose; deep reach design; zinc plated finish; used with A-202 style flush latching handles.

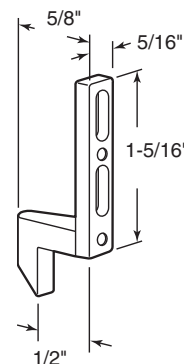

**A-203**

**Latch Strike** (Diecast)

**Contents:** 2 strikes; installation screws.

**Description:** Heavy duty; diecast strike, used by many screen door manufacturers.

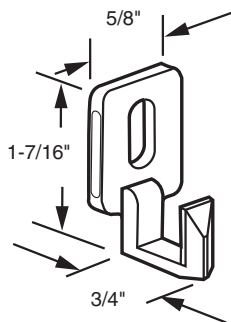

**A-161**

**Latch Strike** (Diecast)

**Contents:** 1 strike; installation screw.

**Description:** Diecast zinc; long 7/8" reach; used by *Window Master*® and others.

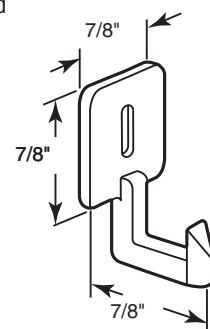

**A-247**

**Latch Strike** (Plastic)

**Contents:** 2 strikes; installation screws.

**Description:** Plastic twin post hook end; primarily used in the south eastern U.S..

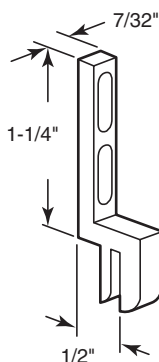

**A-213**

**Latch Strike** (Plastic)

**Contents:** 1 latch strike; installation screws.

**Description:** Black; adjustable; adhesive backing for proper placement prior to drilling jamb for screws, repair part for A-170.

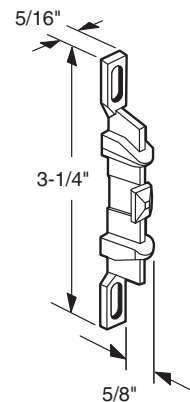

**A-171** (White)

**Top Guide**

**Contents:** 4 guides.

**Description:** Plastic top guide; acts as a guide and anti-rattle device.

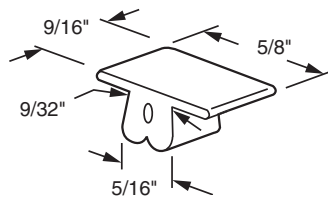

**B-780**

**Bottom Guide**

**Contents:** 2 guides; installation screws.

**Description:** Aluminum bracket with nylon guide; bottom mount; fits on **Croff**® old style doors.

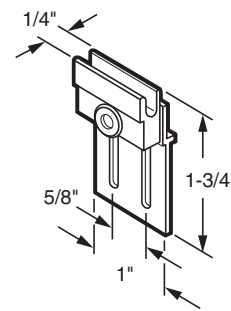

**B-626**

**Bottom Guide**

**Contents:** 2 guides; installation screws.

**Description:** Bottom mount; aluminum housing with nylon spring loaded guide; fits on **Ador "Z"**® doors.

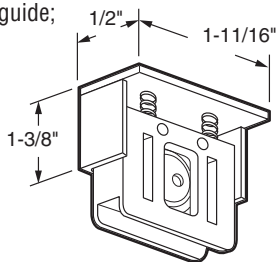

**B-546**

**Bottom Guide**

**Contents:** 2 guides; installation screws.

**Description:** Nylon spring loaded assembly; bottom mount; fits on **Ador**® doors.

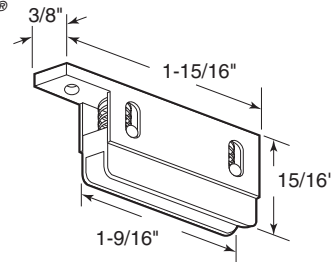

**B-545**

**Bottom Guide**

**Contents:** 2 guides.

**Description:** Nylon bottom guide with adjustment spring and screw; fits on **Tucker**® doors.

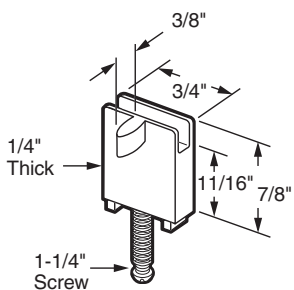

**B-598**

**Bottom Guide**

**Contents:** 2 guides.

**Description:** Nylon bottom guide with spring and cap nut.

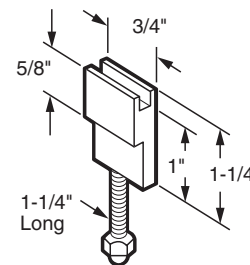

**B-601**

**Top Guide**

**Contents:** 2 guides.

**Description:** Nylon guide with adjustment spring; fits on **Daryl PRI**® doors.

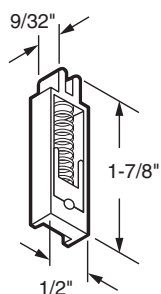

**B-591**

**Top Guide**

**Contents:** 2 guides; with springs and adjustment screws.

**Description:** Nylon guide with adjustment spring; fits on **Daryl PRI**® doors.

**\*Call For Availability**

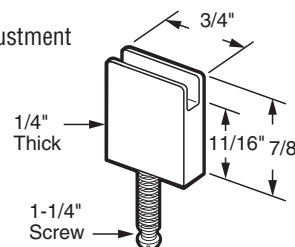

**B-597**

**Guide**

**Contents:** 2 guides.

**Description:** Nylon guide fits on **Tucker**® doors.

**Call For Availability**

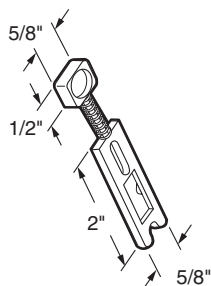

**B-595**

**Top Guide**

**Contents:** 2 guides.

**Description:** Nylon top guides; fits on **Pan Am**® doors.

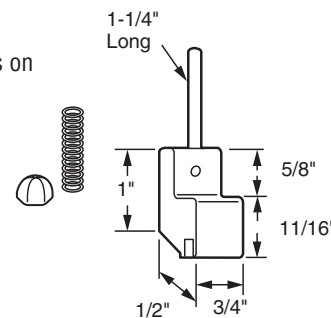

**B-599**

**Guide**

**Contents:** 2 guides.

**Description:** Nylon guide; fits on *Miller*® doors.

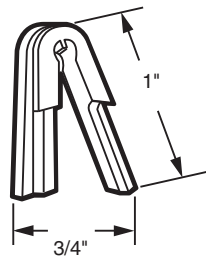

**B-593**

**Bottom Guide**

**Contents:** 4 guides.

**Description:** Nylon guide; fits on *Daryl*® doors.

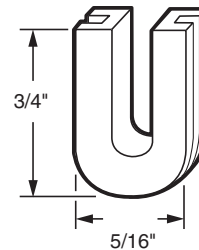

**B-594**

**Bottom Guide**

**Contents:** 2 guides.

**Description:** Nylon guide; fits on *Tucker*® doors.

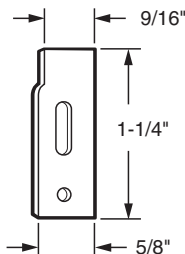

**B-596**

**Guide**

**Contents:** 2 guides.

**Description:** Nylon track guide used to prevent wear on door frame.

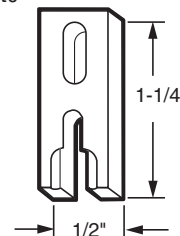

**B-603**

**Bottom Guide**

**Contents:** 2 guides.

**Description:** Nylon bottom guide; fits on *Crossly*® doors.

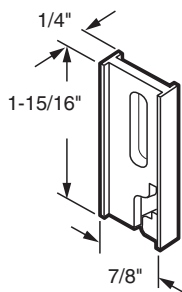

**B-590**

**Top Guide**

**Contents:** 2 guides.

**Description:** Nylon track guide; fits on *Crossly*® doors.

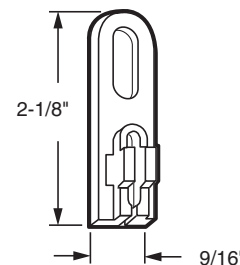

**B-602**

**Top Guide**

**Contents:** 2 guides.

**Description:** Nylon track guide; fits on *Crossly*® doors.

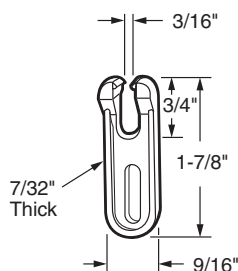

**B-589**

**Top Guide**

**Contents:** 4 guides; with fasteners.

**Description:** Nylon track guide; adjustable; used by many door manufacturers.

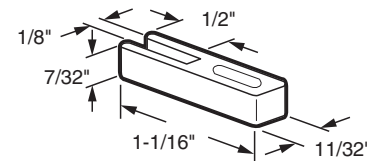

**B-573**

**Bottom Guide**

**Contents:** 4 guides.

**Description:** Clear plastic bottom track guide; prevents excessive wear on door frame; fits on doors by *Keller Industries*.

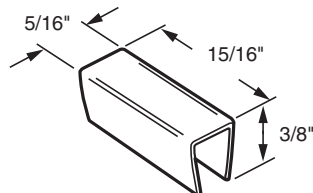

**B-630**

**Bottom Guide**

**Contents:** 2 guides; installation screws.

**Description:** Rigid vinyl guide; bottom mount; fits on *Croft*® series 701 and 702 doors.

Call For Availability

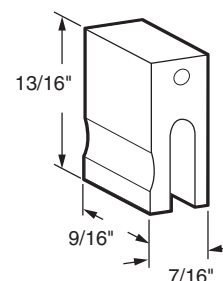

**B-628**

### Adjustment Screw Pack

**Contents:** 4 screws.

**Description:** 8-32 x 1-1/4" Phillips Pan machine screws; adjustment screws for spring tension rollers; used on B-516, B-518, B-608, and B-654.

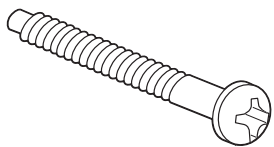

**B-700**

### Roller Adjustment Kit

**Contents:** 4 nylon sleeves; with fasteners.

**Description:** Adjustment screws and nylon sleeves fit on *Anjac*® style spring tension rollers; 7/16" length under head; most commonly used with B-512 style rollers.

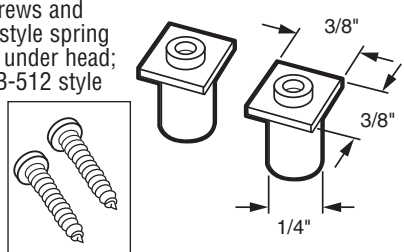

**B-623**

### Bolt Assembly

**Contents:** 4 - 1/4"-20 x 3/4" flat head carriage bolts; with hex nuts.

**Description:** Used with most bottom mount rollers having a 1/4" inside diameter.

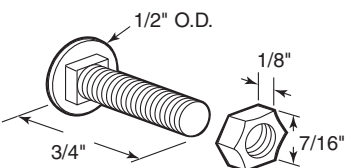

**B-561** (Steel)

**B-774** (Stainless Steel)

### Universal Bug Seal

**Contents:** 5 each per master box.

**Description:** Anodized aluminum molding; 1-1/4" wide vinyl flap is segmented into 1/4" strips you can tear to desired size; pre-punched for screws.

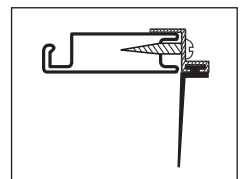
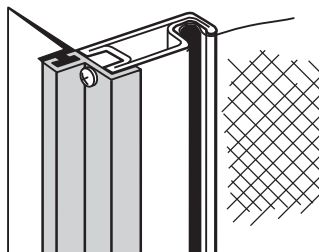

Typical installation on roll-formed door.

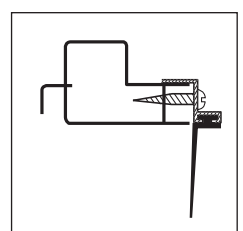

Typical installation on extruded door.

- B-613** (Clear - 84")
- B-614** (Clear - 96")
- B-615** (Black - 84")
- B-616** (Black - 96")
- B-801** (White - 84")
- B-802** (White - 96")

### Screen Door Bug Seal

**Contents:** 1 strip of vinyl.

**Description:** Black vinyl flap has tear strips to adjust width from 7/8" to 1-3/8"; flexible; seals against insects.

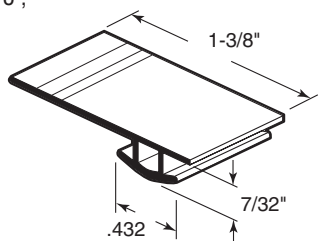

**B-621** (84")

**B-658** (96")

**PL-14697** (250')

### Screen Door Bug Seal

**Contents:** 1 strip of vinyl.

**Description:** Black vinyl flap has tear strips to adjust width from 7/8" to 1-3/8"; flexible; seals against insects.

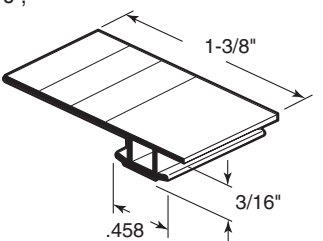

**B-660** (84")

**PL-16172** (100')

### Screen Door Bug Seal

**Contents:** 1 strip of vinyl.

**Description:** Black vinyl flap has tear strips to adjust width from 3/4" to 1-3/8"; flexible; seals against insects.

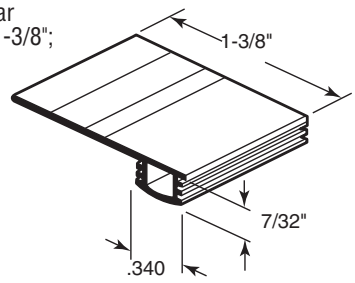

**B-705** (84")

**PL-16063** (100')

### Screen Door Bug Seal

**Contents:** 1 strip of vinyl.

**Description:** Black vinyl flap has tear strips to adjust width from 7/8" to 1-1/2"; flexible; seals against insects.

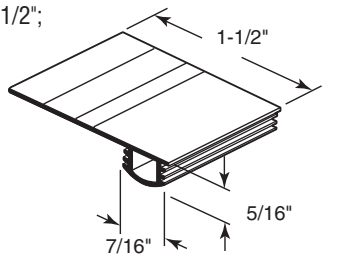

**B-716** (84")

**PL-16349** (100')

### Screen Door Bug Seal

**Contents:** 1 strip of vinyl.

**Description:** Black vinyl flap has tear strips to adjust width from 9/16" to 1-3/16"; flexible; seals against insects; fits *International*® on series No. 900, 925, 950, doors.

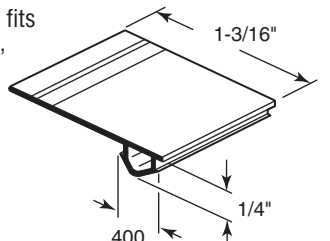

**B-708** (84")

**PL-16160** (100')

### Screen Door Bug Seal

**Contents:** 1 strip of vinyl.

**Description:** Black vinyl flap has tear strips to adjust width from 3/4" to 1 1/8"; flexible, seals against insects.

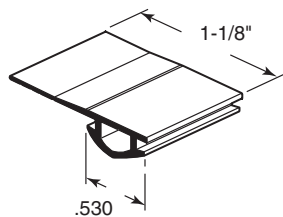

**B-771** (84")  
**PL-16173** (100')

### Screen Door Bug Seal

**Contents:** 1 strip of vinyl.

**Description:** Black vinyl flap has tear strips to adjust width from 1" to 1-3/4"; flexible, seals against insects.

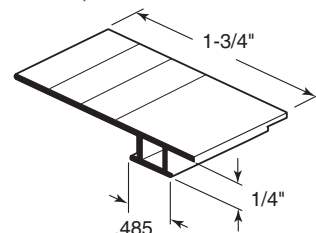

**B-791** (96")  
**PL-16067** (100')

### Screen Door Bug Seal

**Contents:** 1 strip of vinyl.

**Description:** Black vinyl flap has tear strips to adjust width from 7/8" to 1-1/2"; flexible, seals against insects.

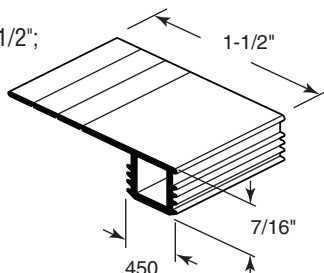

**B-800** (84")

### Screen Door Bug Seal

**Contents:** 1 strip of vinyl.

**Description:** Black vinyl flap has tear strips to adjust width from 7/8" to 1-1/2"; flexible, seals against insects.

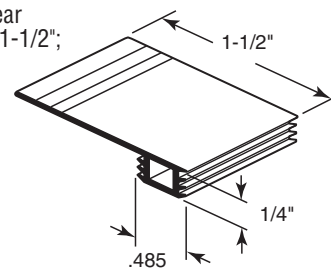

**B-787** (96")

### Door Closer

**Contents:** 1 closer; installation screws.

**Description:** Closes screen doors automatically; reliable and durable; helps keep out flies, moths, mosquitoes, etc; fully adjustable tension and closing speed; paintable aluminum construction; supplied with 2—1-1/4" nylon ball bearing rollers to replace rollers on doors that do not roll freely.

Tube length: 61"  
Tube diameter: 1"

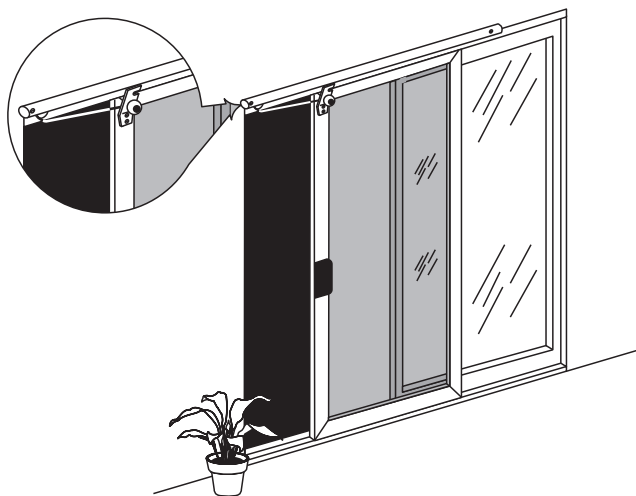

### Door Closer

**Contents:** 1 closer; installation screws.

**Description:** Patented screen door closer; installs in seconds; clock spring torque provides positive closing power; white plastic body will not rust; fits into bug seal channel at door bottom; adjustable tension.

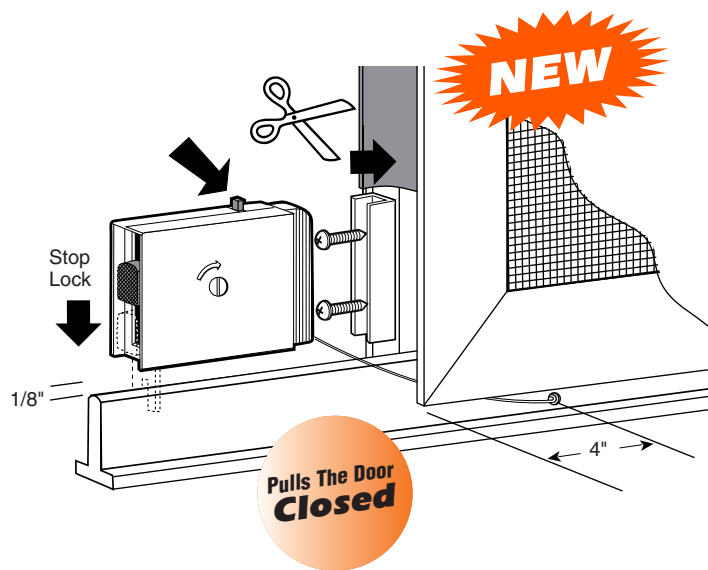

- PL-15535** (Satin Aluminum - Standard Duty)
- PL-15723** (Satin Aluminum - Lite Duty)
- PL-15536** (Bronze - Standard Duty)
- PL-15724** (Bronze - Lite Duty)
- PL-15537** (White - Standard Duty)
- PL-15725** (White - Lite Duty)

- B-784** (Bronze)
- B-757** (White)