

Roller

Contents: 2 rollers.

Description: Steel ball bearing roller; center grooved; 3/16" diameter hole.

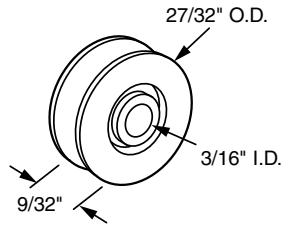

D-1638

Roller

Contents: 2 rollers.

Description: Nylon ball bearing roller; center grooved; 3/16" diameter hole.

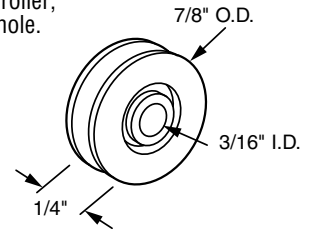

D-1639

Roller

Contents: 2 rollers; 2 axle pins; 2 roll pins; 2 carriage bolts with nuts; 2 rivets; 2 binder posts; (2) 8-32 x 1/2" screws.

Description: Steel ball bearing roller; center grooved; 1/4" diameter hole; includes bolt, axle, rivet kit, roll pin and binder post.

- D-1874** (1" O.D.)
- D-1795** (1-1/8" O.D.)
- D-1796** (1-1/4" O.D.)
- D-1797** (1-1/2" O.D.)

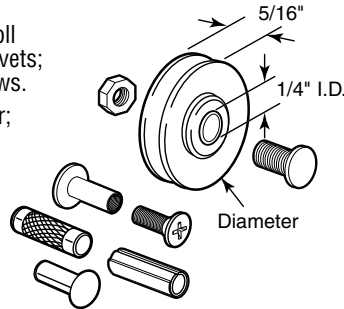

Roller

Contents: 2 rollers; installation bolts.

Description: Steel ball bearing roller; center grooved; 1/4" diameter hole; includes 1/4"-20 x 3/4" carriage bolt.

- D-1500** (1" O.D.)
- D-1501** (1-1/8" O.D.)
- D-1502** (1-1/4" O.D.)

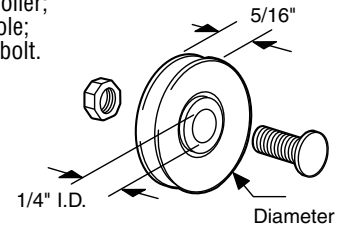

Roller

Contents: 2 rollers.

Description: Steel ball bearing roller; center grooved; 1/4" diameter hole.

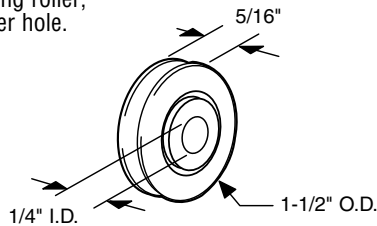

D-1503

Roller

Contents: 2 rollers.

Description: Precision bearing made from hardened steel; center groove wheel; sealed race.

- D-2032** (1-1/4" O.D.)
- D-2033** (1-1/2" O.D.)

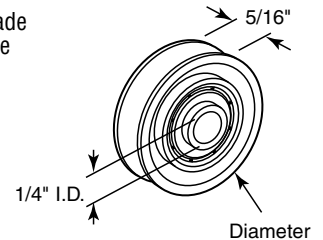

Roller

Contents: 2 rollers.

Description: Precision bearing made from hardened stainless steel; center groove wheel; sealed race.

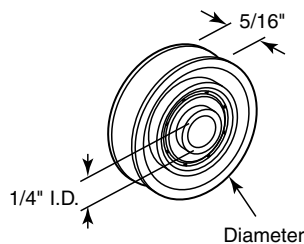

- D-2034** (1-1/4" O.D.)
- D-2035** (1-1/2" O.D.)

Roller

Contents: 2 rollers.

Description: Steel ball bearing roller; center grooved; zinc plated finish.

D-1725

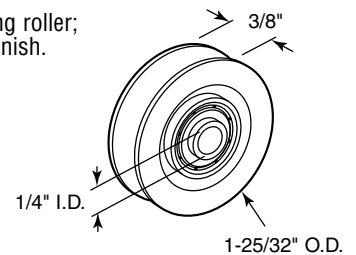

Roller

Contents: 2 rollers.

Description: Ball bearing roller; center grooved; includes built-in axle.

- D-1867** (1-1/8" O.D. - Nylon)
- D-1868** (1-1/4" O.D. - Nylon)
- D-1869** (1-1/2" O.D. - Nylon)
- D-1854** (1-1/8" O.D. - Steel)
- D-1765** (1-1/4" O.D. - Steel - precision)
- D-1766** (1-1/2" O.D. - Steel - precision)

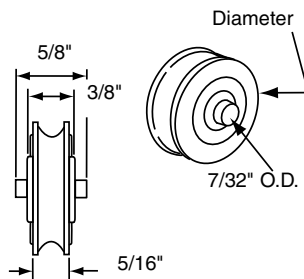

Roller

Contents: 2 rollers.

Description: Stainless steel ball bearing roller; center grooved; includes built-in axle.

- D-1838** (1-1/8" O.D.)
- D-1839** (1-1/4" O.D. Precision)
- D-1787** (1-1/2" O.D. Precision)

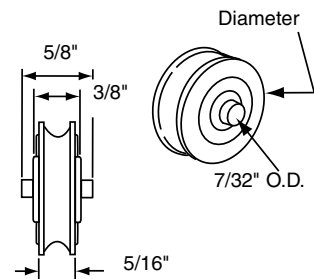

Roller

Contents: 1 roller.

Description: Steel ball bearing roller; center grooved; includes built-in axle; narrow axle.

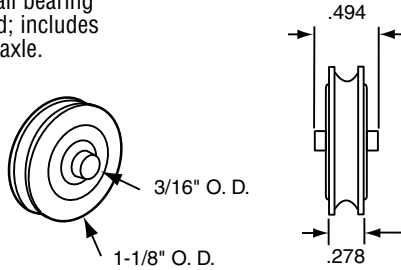

D-1913

Roller

Contents: 2 rollers.

Description: Stainless steel ball bearing roller; center grooved; 1/4" diameter hole.

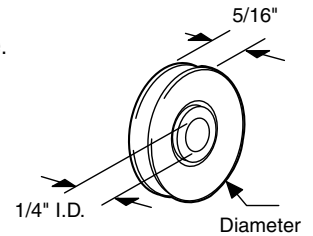

D-1692 (1-1/8" O.D.)
D-1693 (1-1/4" O.D.)
D-1694 (1-1/2" O.D.)

Roller

Contents: 2 rollers.

Description: Ball bearing roller; center grooved; 3/8" diameter hole.

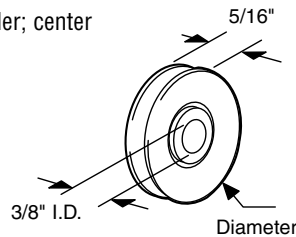

D-1703 (1-1/4" O.D. - Steel)
D-1704 (1-1/2" O.D. - Steel)

Roller

Contents: 2 rollers.

Description: Nylon wheel; steel ball bearing roller; center grooved; 3/16" diameter hole.

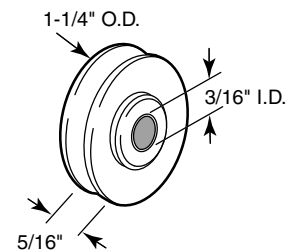

D-1881

Roller

Contents: 2 rollers; 2 axle pins; 2 roll pins; 2 carriage bolts with nuts; 2 rivets; 2 binder posts; (2) 8-32 x 1/2" screws.

Description: Nylon ball bearing roller; center grooved; 1/4" diameter hole; includes bolt, axle, rivet kit, roll pin and binder post.

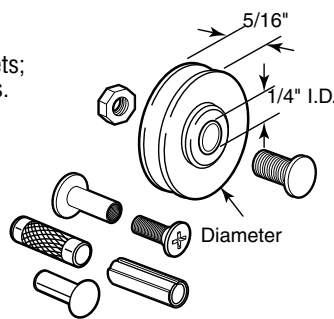

D-1798 (1-1/4" O.D.)
D-1799 (1-1/2" O.D.)

Roller

Contents: 2 rollers; installation bolts.

Description: Nylon wheel; steel ball bearing roller; center grooved; 1/4" diameter hole; includes 1/4"-20 x 3/4" carriage bolt.

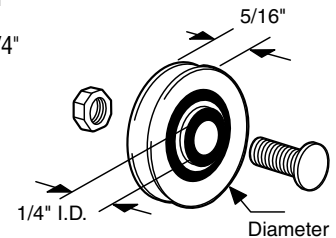

D-1865 (1-1/8" O.D.)
D-1504 (1-1/4" O.D.)

Roller

Contents: 2 rollers.

Description: Nylon wheel; steel ball bearing roller; center grooved; 1/4" diameter hole.

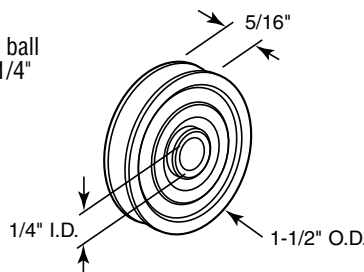

D-1506

Roller

Contents: 2 rollers; 2 axle pins; 2 roll pins; 2 carriage bolts with nuts.

Description: Nylon wheel; steel ball bearing roller; center grooved; 1/4" diameter hole; includes bolt, axle and rivet kit.

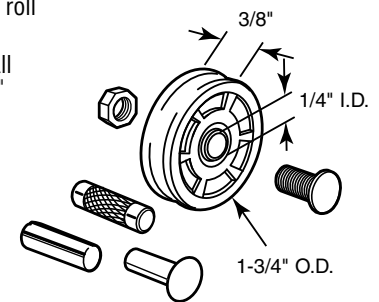

D-1800

Roller

Contents: 2 rollers.

Description: Nylon wheel; steel ball bearing roller; center grooved; 1/4" diameter hole; .432 wide hub.

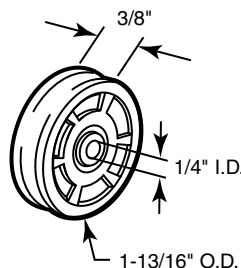

D-1507

Roller

Contents: 2 rollers.

Description: Nylon wheel; ball bearing roller; center grooved; 1/4" diameter hole; .475 wide hub.

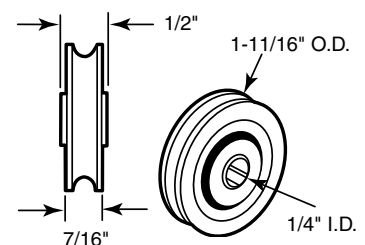

D-1716 (Steel race)
D-2037 (Stainless steel race)

Roller

Contents: 2 rollers; 2 axle assemblies w/locking rivets.

Description: Nylon wheel; steel ball bearing roller; center grooved; 1/4" diameter off-center hole for vertical adjustment.

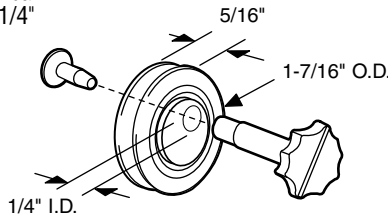

D-1505

Roller

Contents: 2 rollers.

Description: Nylon roller; non-bearing; center grooved; 3/8" diameter hole.

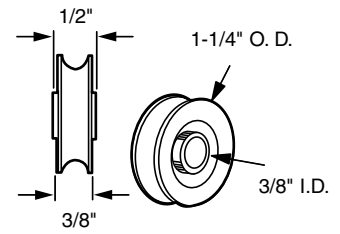

D-1713

Roller

Contents: 2 rollers.

Description: Flat steel ball bearing roller; 1/4" diameter hole.

Call For Availability

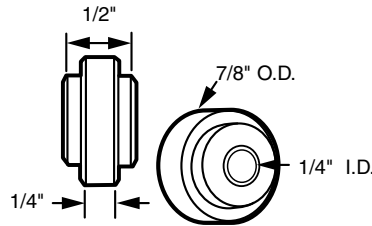

D-1712

Roller

Contents: 2 rollers; installation bolts.

Description: Flat steel ball bearing roller; 1/4" diameter hole; includes 1/4"-20 x 3/4" carriage bolt.

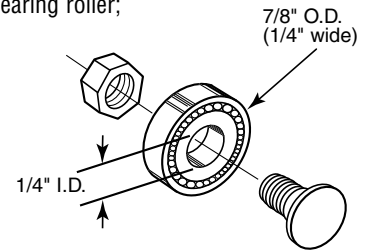

D-1760

Roller

Contents: 2 rollers.

Description: Flat nylon wheel; steel ball bearing roller only; for replacement onto existing diecast top bracket; fits on *Harrow*[®].

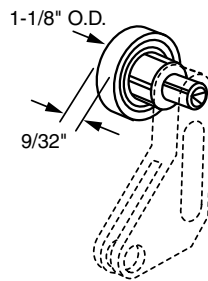

D-1641

Roller

Contents: 2 rollers with nylon housings.

Description: Steel ball bearing roller; nylon housing; fits on *Horizon*[®] and other patio door manufacturers.

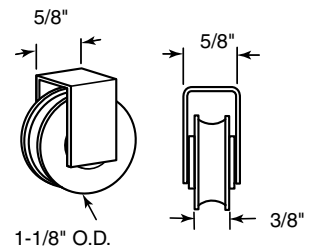

D-1567

Roller Housing

Contents: 2 brackets.

Description: Nylon housing used to hold D-1567 roller assembly; fits on *Horizon*[®] and other manufacturers.

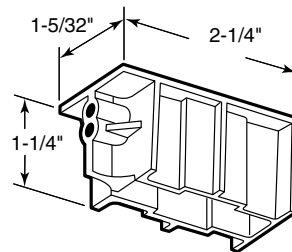

D-1566

Axle Repair Kit

Contents: 2 stepped axles; 2 roll pins; 2 standard 1/4" rivets; 2-1/4"-20 carriage bolts; 2-1/4"-20 hex nuts; 2- binder posts and screws.

Description: Stepped axles; roll pins; standard 1/4" rivets; 1/4"-20 carriage bolts; 1/4"-20 hex nuts; binder posts and screws.

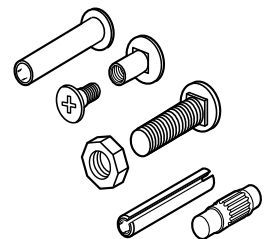

D-1861

Axle Pins

Contents: 2-.625" long pins; 2-.710" long pins; 2-.810" long pins.

Description: Axle pins are zinc plated; knurled surface for tight fit; 2-.625" long pins; 2-.710" long pins; 2-.810" long pins.

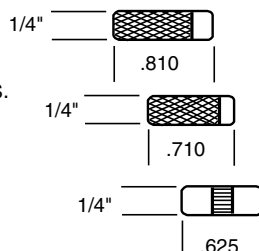

D-1642

Tandem Roller Assembly

Contents: 1 roller assembly.

Description: Ball bearing tandem roller assembly; side adjustable steel housing; used on vinyl and wood patio doors.

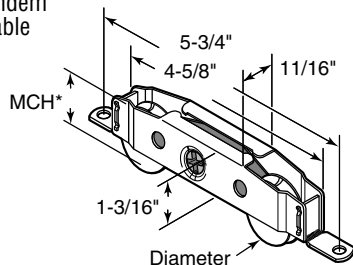

D-1730 (1-1/4" O.D. Nylon - 1-1/2" MCH)

D-1607 (1-1/4" O.D. Steel - 1-1/2" MCH)

D-1855 (1-1/2" O.D. Nylon - 1-3/4" MCH)

Tandem Roller Assembly

Contents: 1 roller assembly.

Description: Stainless steel ball bearing tandem roller assembly; side adjustable stainless steel housing; ideal for use in corrosive conditions.

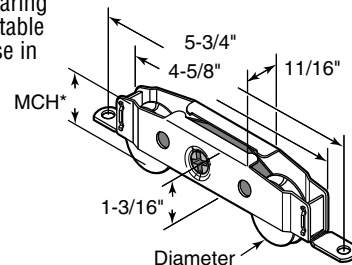

D-1607-SS (1-1/4" O.D. - 1-1/2" MCH)

D-1855-SS (1-1/2" O.D. - 1-3/4" MCH)

Tandem Roller Assembly

Contents: 1 roller assembly.

Description: Flat nylon ball bearing tandem roller assembly; side adjustable steel housing; used on vinyl and wood patio doors.

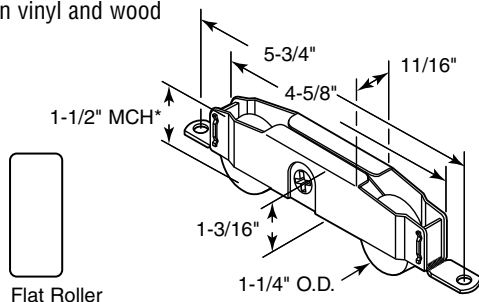

D-2036

Tandem Roller Assembly

Contents: 1 roller assembly.

Description: Nylon ball bearing tandem roller assembly; side adjustable steel housing; **offset mounting tabs**; used on vinyl and wood patio doors.

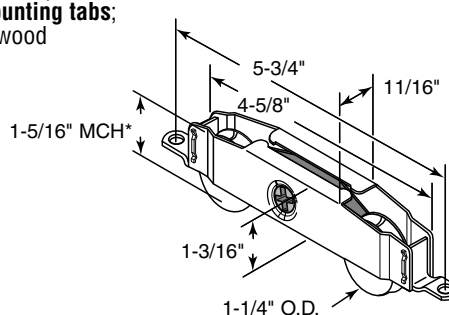

D-2000

Tandem Roller Assembly

Contents: 1 roller assembly.

Description: Steel ball bearing tandem roller assembly; side adjustable steel housing; used on vinyl and wood patio doors.

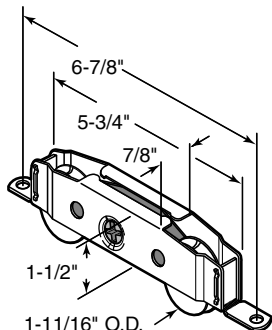

D-1994

Tandem Roller Assembly

Contents: 1 roller assembly.

Description: Steel ball bearing tandem roller assembly; side adjustable steel housing; **inverted mounting tabs**; used on vinyl and wood patio doors.

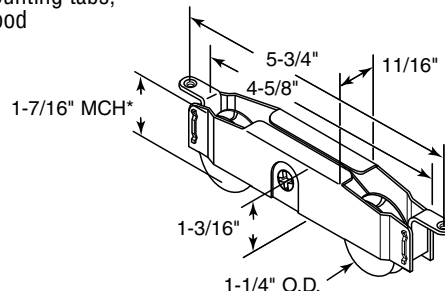

D-1882

Tandem Roller Assembly

Contents: 1 roller assembly.

Description: Stainless steel ball bearing tandem roller assembly; end adjustable stainless steel housing; ideal for use in corrosive conditions.

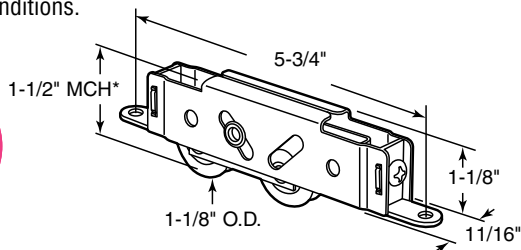

D-2006

Tandem Roller Assembly

Contents: 1 roller assembly.

Description: Steel ball bearing tandem roller assembly; end adjustable steel housing; used by several door manufacturers.

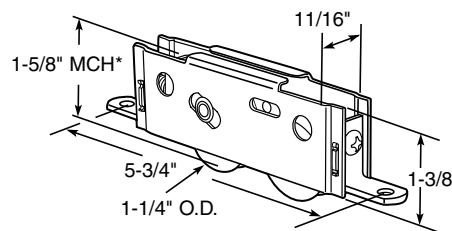

D-1990

Tandem Roller Assembly

Contents: 1 roller assembly.

Description: Steel ball bearing tandem roller assembly; end adjustable steel housing; used by several door manufacturers.

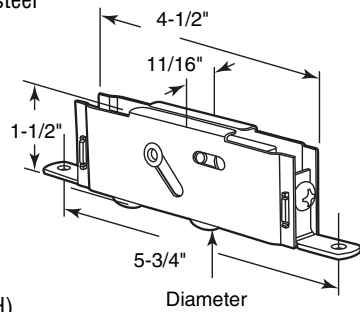

D-1980 (1" O.D. - 1-9/16" MCH)

D-1991 (1-1/4" O.D. - 1-11/16" MCH)

Roller Assembly Shim

Contents: 1 shim.

Description: Plastic shim for use with D-1607 style roller assemblies; shim is snapped onto top of roller housing to shim housing height; used on vinyl doors only.

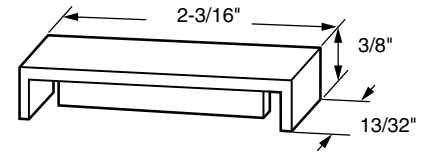

D-1992

Tandem Roller Assembly

Contents: 1 roller assembly.

Description: Steel ball bearing tandem roller assembly; side adjustable steel housing; fits Andersen® patio doors.

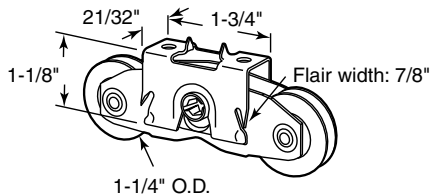

D-1971

Tandem Roller Assembly

Contents: 1 roller assembly.

Description: Steel ball bearing tandem roller assembly; adjustable steel housing; used by several manufacturers.

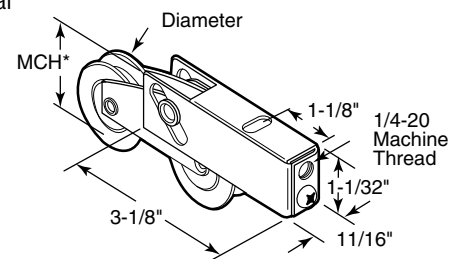

D-1979 (1" O.D. - 1-5/16" MCH)

D-1735 (1-1/4" O.D. - 1-9/32" MCH)

Tandem Roller Assembly

Contents: 1 roller assembly.

Description: Ball bearing tandem roller assembly; adjustable steel housing; used by several manufacturers.

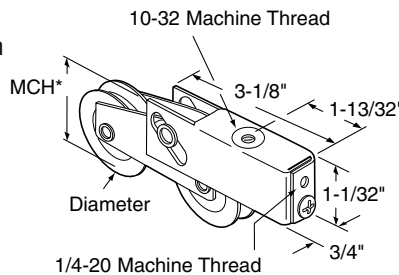

D-1739 (1-1/4" O.D. Nylon - 1-3/8" MCH)

D-1986 (1-1/4" O.D. Steel - 1-3/8" MCH)

D-1899 (1-1/2" O.D. Nylon - 1-1/2" MCH)

D-1754 (1-1/2" O.D. Steel - 1-1/2" MCH)

Tandem Roller Assembly

Contents: 1 roller assembly.

Description: Stainless steel ball bearing tandem roller assembly; adjustable stainless steel housing; ideal for use in corrosive conditions.

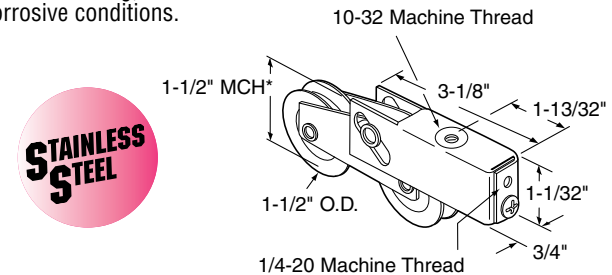

D-1754-SS

Tandem Roller Assembly

Contents: 1 roller assembly.

Description: Steel ball bearing tandem roller assembly; adjustable steel housing; used by several manufacturers.

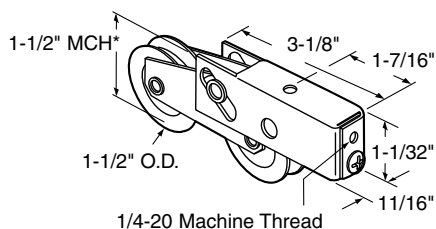

D-1987

Tandem Roller Assembly

Contents: 1 roller assembly.

Description: Steel ball bearing tandem roller assembly; adjustable steel housing; hooks snap into bottom door rail; fits on Smith Carry® doors and several other door manufacturers.

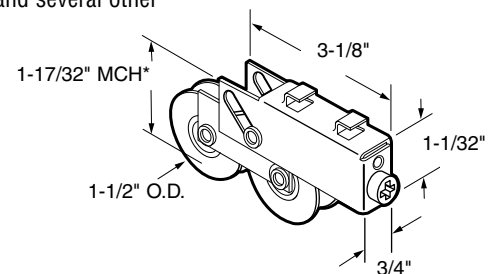

D-1736

Tandem Roller Assembly

Contents: 1 roller assembly.

Description: Steel ball bearing tandem roller assembly; adjustable steel housing.

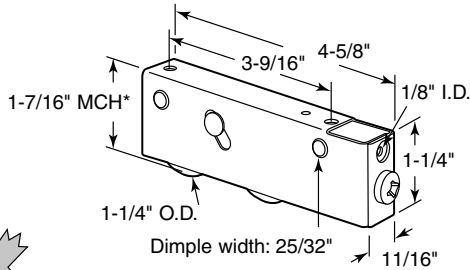

D-1938

Used primarily in Canada

Tandem Roller Assembly

Contents: 1 roller assembly.

Description: Ball bearing tandem roller assembly; diecast housing; fits on *Kawneer*® doors.

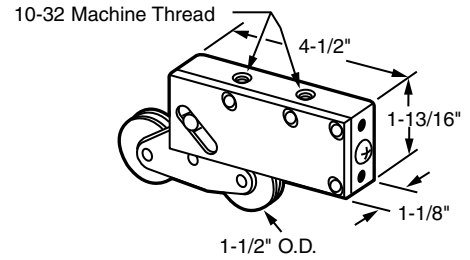

D-1586 (Steel)

D-1586-SS (Stainless steel)

Tandem Roller Assembly

Contents: 1 roller assembly.

Description: Steel ball bearing tandem roller assembly; adjustable steel housing; fits on *Armour Vue*® and *Atlas*® doors.

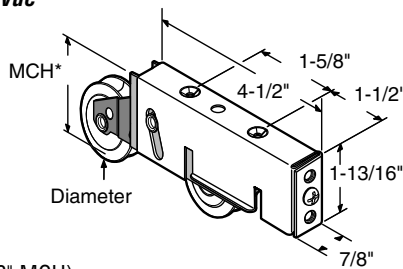

D-1549 (1-1/2" O.D. - 2-5/16" MCH)

D-1843 (1-13/16" O.D. - 2-13/32" MCH)

Tandem Roller Assembly

Contents: 1 roller assembly.

Description: Stainless steel ball bearing tandem roller assembly; adjustable stainless steel housing; fits on *Armour Vue*® and *Atlas*® doors.

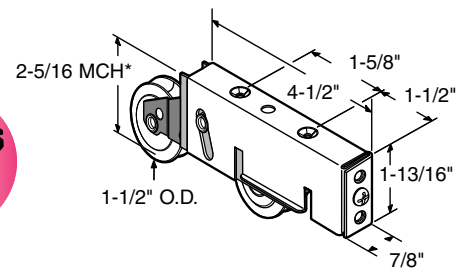

D-1549-SS

Tandem Roller Assembly

Contents: 1 roller assembly.

Description: Steel ball bearing tandem roller assembly; adjustable steel housing; used by several door manufacturers.

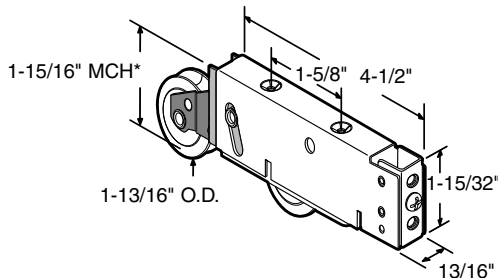

D-2007

Tandem Roller Assembly

Contents: 1 roller assembly.

Description: Steel ball bearing tandem roller assembly; adjustable steel housing; used by several door manufacturers.

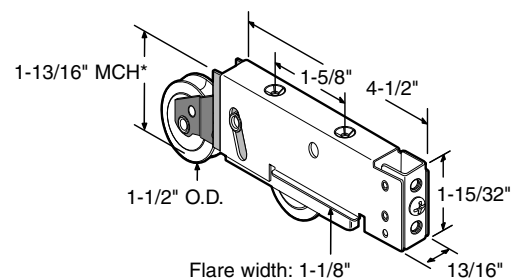

D-1924

Tandem Roller Assembly

Contents: 1 roller assembly.

Description:

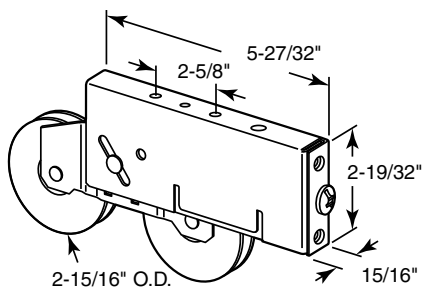

D-2038

Tandem Roller Assembly

Contents: 1 roller assembly.

Description: Steel ball bearing tandem roller assembly; adjustable steel housing; used by several door manufacturers.

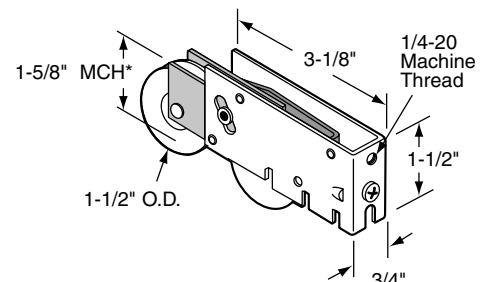

D-1904

Tandem Roller Assembly

Contents: 1 roller assembly.

Description: Steel ball bearing tandem roller assembly; adjustable steel housing; fits on Fleetwood® doors.

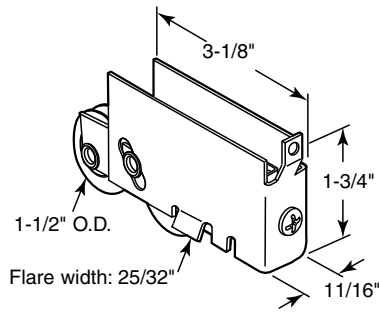

D-1862

Tandem Roller Assembly

Contents: 1 roller assembly.

Description: Stainless steel ball bearing tandem roller assembly; adjustable stainless steel housing; fits on Fleetwood® doors.

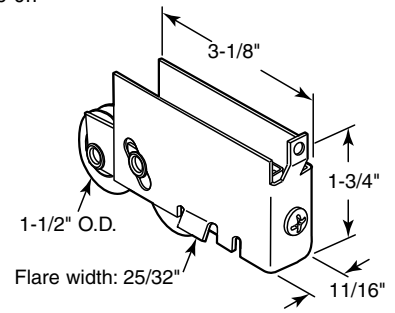

D-1862-SS

Tandem Roller Assembly

Contents: 1 roller assembly.

Description: Stainless steel ball bearing tandem roller assembly; extruded aluminum housing.

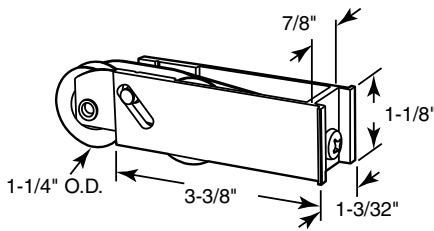

D-2015

Tandem Roller Assembly

Contents: 1 roller assembly.

Description: Nylon ball bearing tandem roller assembly; extruded aluminum housing; stainless steel inner carriage; used by several door manufacturers.

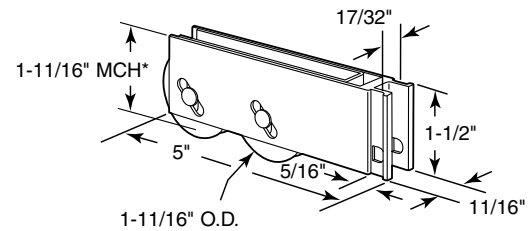

D-1995

Tandem Roller Assembly

Contents: 1 roller assembly.

Description: Nylon ball bearing tandem roller assembly; extruded aluminum housing; stainless steel inner carriage; unique track cleaner built into rear of housing.

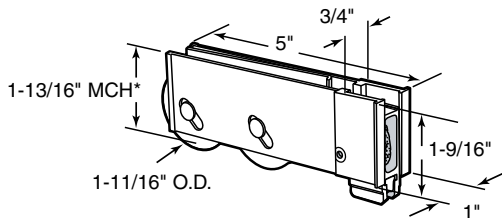

D-1993

Tandem Roller Assembly

Contents: 1 roller assembly.

Description: Steel ball bearing tandem roller assembly; adjustable steel housing; used on vinyl doors by several door manufacturers.

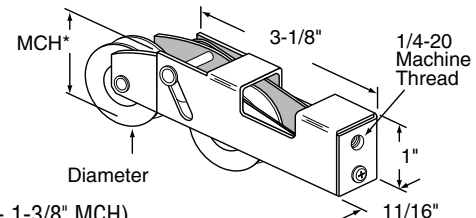

D-1858 (1-1/4" O.D. - 1-3/8" MCH)

D-1989 (1-1/2" O.D. - 1-1/2" MCH)

Tandem Roller Assembly

Contents: 1 roller assembly.

Description: Steel ball bearing tandem roller assembly; adjustable steel housing; used on vinyl doors by several door manufacturers.

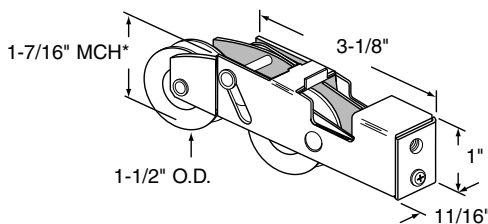

D-1988

Tandem Roller Assembly

Contents: 1 roller assembly.

Description: Ball bearing tandem roller assembly; adjustable steel housing; used on vinyl doors by several door manufacturers.

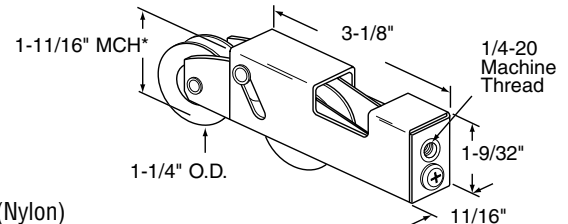

D-1920 (Nylon)

D-2050 (Steel)

Tandem Roller Assembly

Contents: 1 roller assembly.

Description: Ball bearing tandem roller assembly; adjustable steel housing; 1/4-20 mounting hole; used by several door manufacturers.

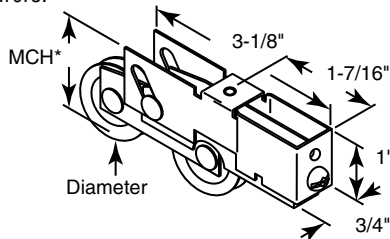

D-1791 (1-1/8" O.D. Steel - 1-5/16" MCH)

D-1940 (1-1/2" O.D. Nylon - 1-1/2" MCH)

Tandem Roller Assembly

Contents: 1 roller assembly.

Description: Steel ball bearing tandem roller assembly; adjustable steel housing; extruded mounting hole for a 10-24 self tapping screw; used by several door manufacturers.

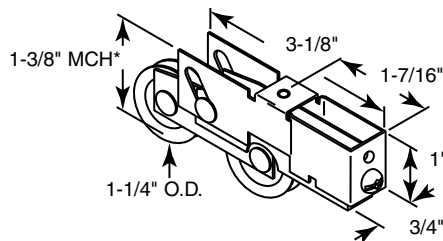

D-1808

Tandem Roller Assembly

Contents: 1 roller assembly.

Description: Ball bearing tandem roller assembly; adjustable steel housing; used by several door manufacturers.

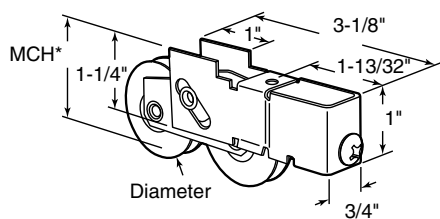

D-1919 (1-1/4" O.D. - 1-5/8" MCH)

D-1996 (1-1/2" O.D. - 1-25/32" MCH)

Tandem Roller Assembly

Contents: 1 roller assembly.

Description: Steel ball bearing tandem roller assembly; adjustable steel housing; used by several door manufacturers.

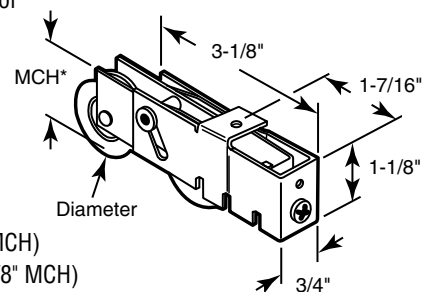

D-1982 (1" O.D. - 1-1/8" MCH)

D-1983 (1-1/4" O.D. - 1-3/8" MCH)

D-1984 (1-1/2" O.D. - 1-5/8" MCH)

Tandem Roller Assembly

Contents: 1 roller assembly.

Description: Steel ball bearing tandem roller assembly; adjustable steel housing; used by several door manufacturers.

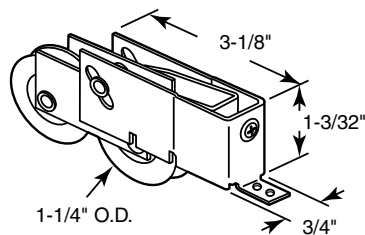

D-1916

Tandem Roller Assembly

Contents: 1 roller assembly.

Description: Steel ball bearing tandem roller; adjustable steel housing; low carriage allows for door removal; fits on Merzon® doors.

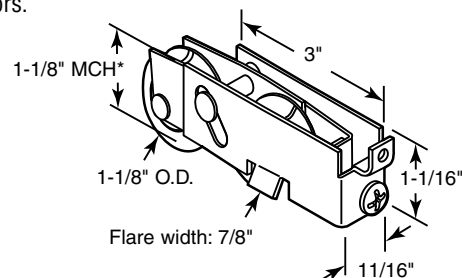

D-1908

Tandem Roller Assembly

Contents: 1 roller assembly.

Description: Ball bearing roller assembly; adjustable steel housing; fits on Pacific® and other patio door manufacturers.

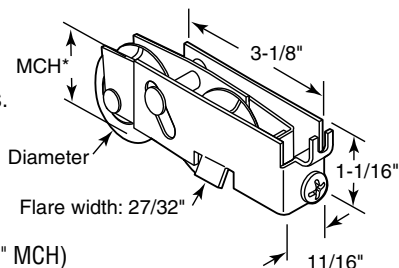

D-1985 (1" O.D. Steel - 1-1/4" MCH)

D-1551 (1-1/8" O.D. Steel - 1-5/16" MCH)

D-1852 (1-1/4" O.D. Nylon - 1-7/16" MCH)

D-1552 (1-1/4" O.D. Steel - 1-7/16" MCH)

D-1864 (1-1/4" O.D. Steel - 1-7/16" MCH - .740 width)

Tandem Roller Assembly

Contents: 1 roller assembly.

Description: Stainless steel ball bearing roller assembly; adjustable stainless steel housing; fits on Pacific® and other patio door manufacturers.

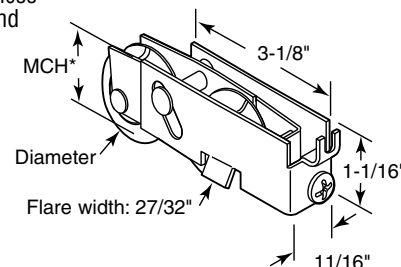

D-1551-SS (1-1/8" O.D. - 1-5/16" MCH)

D-1552-SS (1-1/4" O.D. - 1-7/16" MCH)

Tandem Roller Assembly

Contents: 1 roller assembly.

Description: Ball bearing roller assembly; adjustable steel housing; used by several door manufacturers.

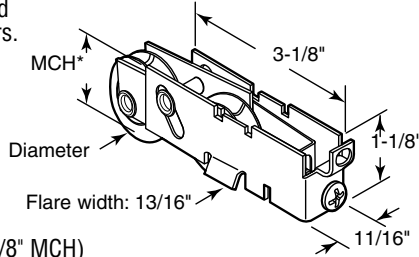

D-1846 (1" O.D. Steel - 1-1/8" MCH)

D-1847 (1-1/8" O.D. Steel - 1-5/16" MCH)

D-2049 (1-1/4" O.D. Nylon - 1-7/16" MCH)

D-1845 (1-1/4" O.D. Steel - 1-7/16" MCH)

Tandem Roller Assembly

Contents: 1 roller assembly.

Description: Ball bearing tandem roller assembly; adjustable steel housing; fits on *Fleetwood*® and other manufacturers.

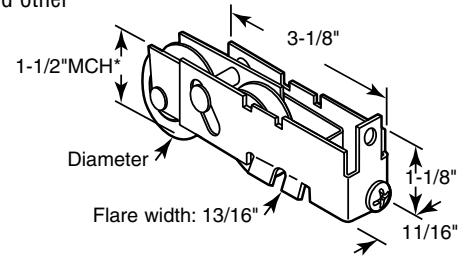

D-1553 (Nylon)

D-1844 (Steel)

Tandem Roller Assembly

Contents: 1 roller assembly.

Description: Stainless steel ball bearing tandem roller assembly; adjustable stainless steel housing; fits on *Fleetwood*® and other manufacturers.

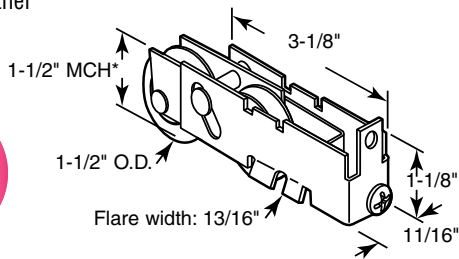

D-1844-SS

Tandem Roller Assembly

Contents: 1 roller assembly.

Description: Ball bearing tandem roller assembly; adjustable steel housing; used on vinyl doors by several door manufacturers.

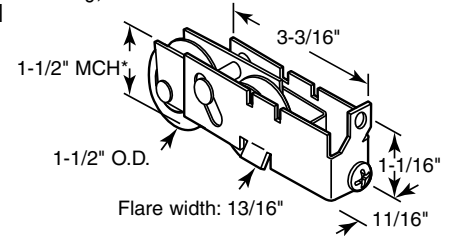

D-2014 (1-1/8" O.D. Steel - 1-1/4" MCH)

D-1738 (1-1/2" O.D. Nylon - 1-1/2" MCH)

Tandem Roller Assembly

Contents: 1 roller assembly.

Description: Steel ball bearing roller assembly; adjustable steel housing; used by several door manufacturers.

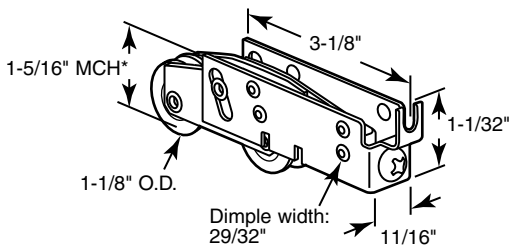

D-1981

Tandem Roller Assembly

Contents: 1 roller assembly.

Description: Ball bearing tandem roller assembly; adjustable steel housing; fits on *Fleetwood*® and other manufacturers.

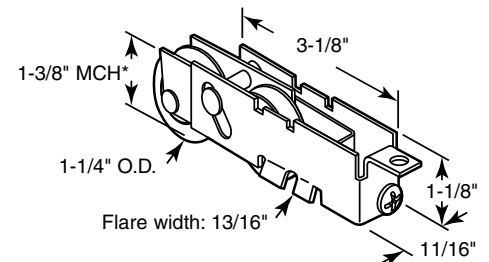

D-1880

Tandem Roller Assembly

Contents: 1 roller assembly.

Description: Ball bearing tandem roller assembly; adjustable steel housing; used by several door manufacturers.

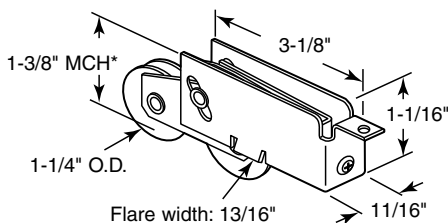

D-1915 (Nylon)

D-1775 (Steel)

Tandem Roller Assembly

Contents: 1 roller assembly.

Description: Steel ball bearing roller assembly; adjustable steel housing; used by several door manufacturers.

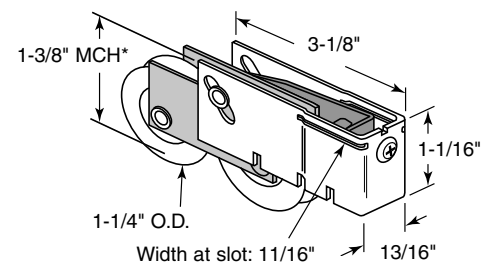

D-1917

Tandem Roller Assembly

Contents: 1 roller assembly.

Description: Steel ball bearing tandem roller assembly; adjustable steel housing; fits on *Bee Cee*® doors.

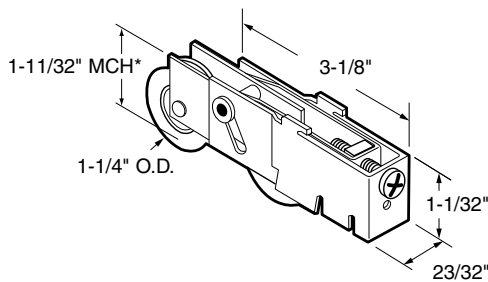

D-1689

Tandem Roller Assembly

Contents: 1 roller assembly.

Description: Ball bearing tandem roller assembly; adjustable steel housing; fits on *Window Master*® doors.

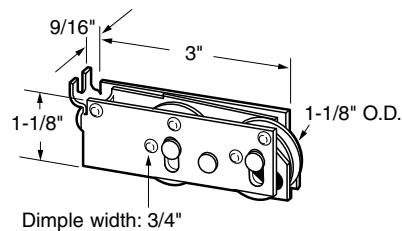

D-2011 (Nylon)

D-1727 (Steel)

Tandem Roller Assembly

Contents: 1 roller assembly.

Description: Ball bearing tandem roller assembly; adjustable stainless steel housing; fits on *Window Master*® doors.

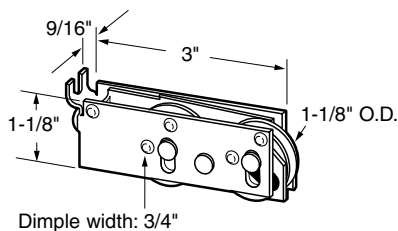

D-2012 (Nylon)

D-2013 (Stainless steel)

Tandem Roller Assembly

Contents: 1 roller assembly.

Description: Nylon rollers with aluminum housing; narrow 3/16" groove width.

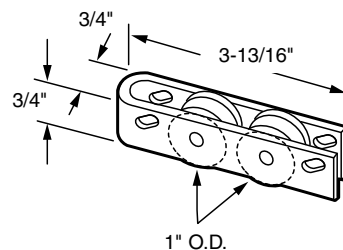

D-1643

Tandem Roller Assembly

Contents: 1 roller assembly.

Description: Ball bearing roller assembly; adjustable steel housing; fits on *Guaranteed Products*® doors.

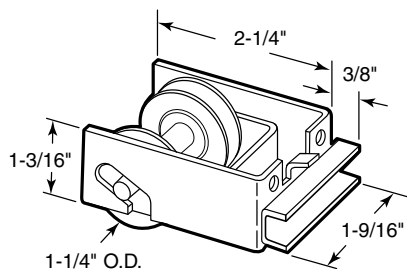

D-1547 (Nylon)

D-1548 (Steel)

Roller Assembly

Contents: 1 roller assembly.

Description: Steel ball bearing roller assembly; adjustable steel housing; used by several manufacturers.

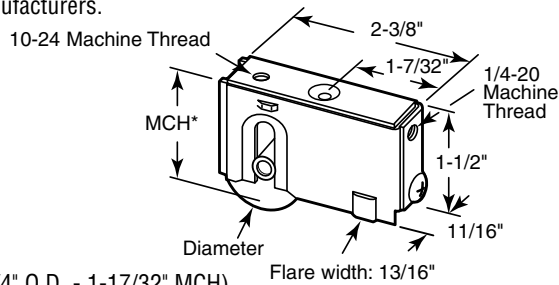

D-1542 (1-1/4" O.D. - 1-17/32" MCH)

D-1750 (1-1/2" O.D. - 1-23/32" MCH)

Roller Assembly

Contents: 1 roller assembly.

Description: Ball bearing roller assembly; adjustable steel housing; fits on *Blomberg*® and other patio door manufacturers.

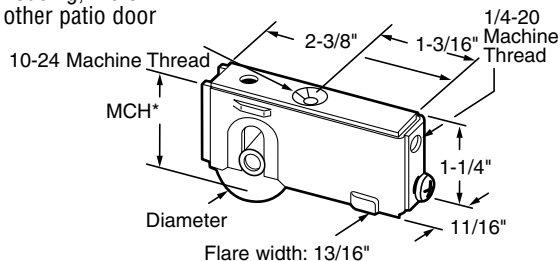

D-1541 (1-1/4" O.D. Steel - 1-7/16" MCH)

D-2008 (1-1/2" O.D. Nylon - 1-9/16" MCH)

Roller Assembly

Contents: 1 roller assembly.

Description: Ball bearing roller assembly; adjustable steel housing; fits on *Daryl*®, *Patio Magic*® and other patio door manufacturers.

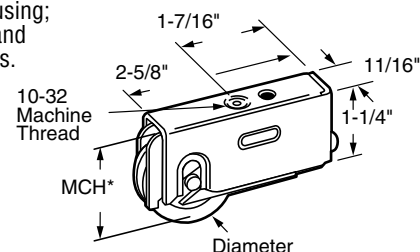

D-1896 (1-1/4" O.D. Steel - 1-1/2" MCH)

D-1597 (1-1/2" O.D. Nylon - 1-11/16" MCH)

D-1594 (1-1/2" O.D. Steel - 1-11/16" MCH)

Roller Assembly

Contents: 1 roller assembly.

Description: Stainless steel ball bearing roller assembly; adjustable stainless steel housing; fits on *Daryl*[®], *Patio Magic*[®] and other patio door manufacturers.

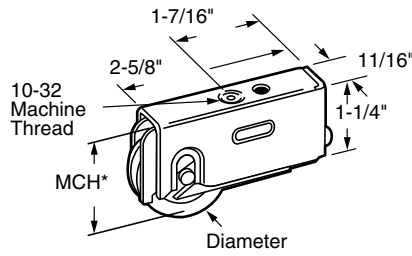

D-1594-SS

Roller Assembly

Contents: 1 roller assembly.

Description: Ball bearing roller assembly; adjustable steel housing; fits on *Air Control*[®], *Howmet*[®], *Krestmark*[®] and others.

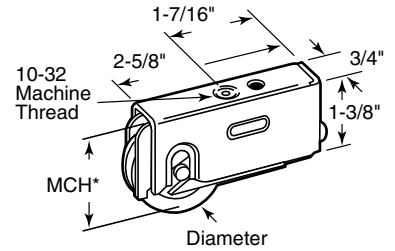

- D-1724** (1-1/4" O.D. Nylon - 1-3/8" MCH)
- D-1723** (1-1/4" O.D. Steel - 1-3/8" MCH)
- D-1786** (1-1/2" O.D. Nylon - 1-1/2" MCH)
- D-1563** (1-1/2" O.D. Steel - 1-1/2" MCH)

Roller Assembly

Contents: 1 roller assembly.

Description: Stainless steel ball bearing roller assembly; adjustable stainless steel housing; fits on *Air Control*[®], *Howmet*[®], *Krestmark*[®] and others.

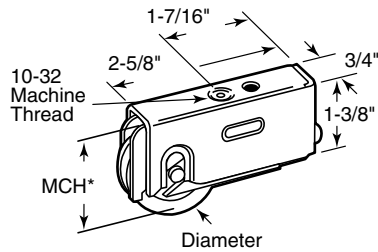

D-1563-SS

Roller Assembly

Contents: 1 roller assembly.

Description: Steel ball bearing roller assembly; adjustable steel housing; instructions show conversion from old style.

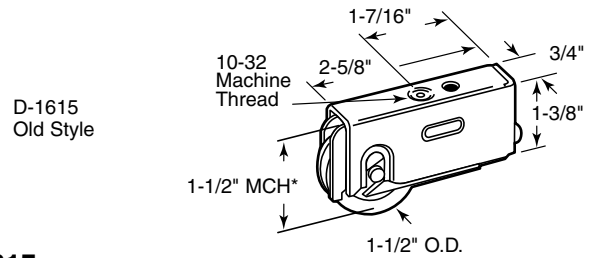

D-1615

Roller Assembly

Contents: 1 roller assembly.

Description: Ball bearing roller assembly; adjustable steel housing; used by many patio door manufacturers.

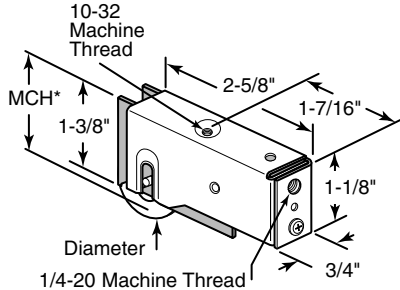

- D-1834** (1-1/4" O.D. Nylon - 1-17/32" MCH)
- D-1832** (1-1/4" O.D. Steel - 1-17/32" MCH)
- D-1833** (1-1/2" O.D. Nylon - 1-19/32" MCH)
- D-1831** (1-1/2" O.D. Steel - 1-19/32" MCH)

Roller Assembly

Contents: 1 roller assembly.

Description: Ball bearing roller assembly; adjustable steel housing; fits on several patio door manufacturers.

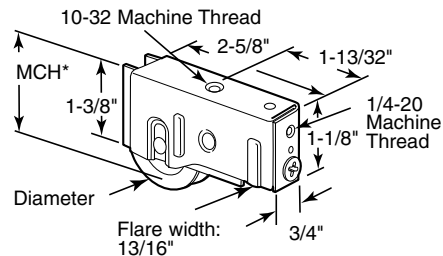

- D-1907** (1-1/4" O.D. Nylon - 1-1/2" MCH)
- D-1957** (1-1/2" O.D. Nylon - 1-9/16" MCH)
- D-1860** (1-1/2" O.D. Steel - 1-9/16" MCH)

Roller Assembly

Contents: 1 roller assembly.

Description: Steel ball bearing roller assembly; adjustable steel housing; used by many patio door manufacturers.

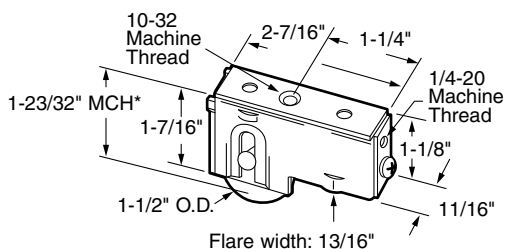

D-1947

Roller Assembly

Contents: 1 roller assembly.

Description: Stainless steel ball bearing roller assembly; adjustable stainless steel housing; used by many patio door manufacturers.

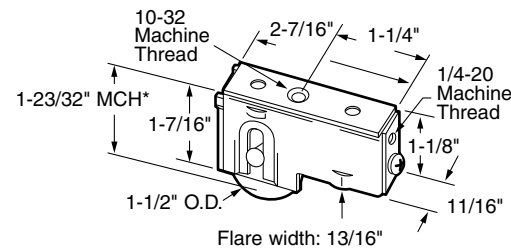

D-1948

Roller Assembly

Contents: 1 roller assembly.

Description: Ball bearing roller assembly; adjustable steel housing; fits on **Fleetwood®** and other patio door manufacturers.

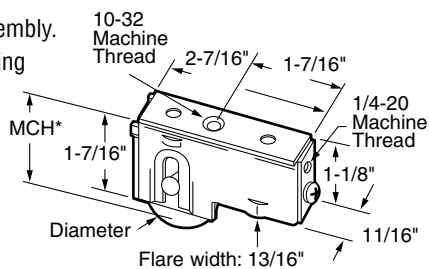

D-1748 (1-1/8" O.D. Steel - 1-19/32" MCH)

D-1849 (1-1/4" O.D. Nylon - 1-21/32" MCH)

D-1747 (1-1/4" O.D. Steel - 1-21/32" MCH)

D-1973 (1-1/2" O.D. Nylon - 1-23/32" MCH)

D-1537 (1-1/2" O.D. Steel - 1-23/32" MCH)

Roller Assembly

Contents: 1 roller assembly.

Description: Steel ball bearing roller assembly; adjustable steel housing; fits on **Acorn Door®** and other patio door manufacturers.

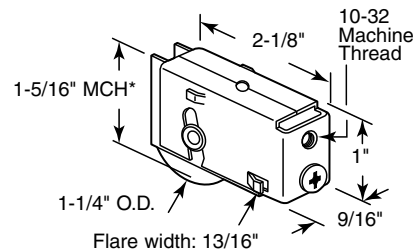

D-1554

Roller Assembly

Contents: 1 roller assembly.

Description: Steel ball bearing roller assembly; adjustable steel housing.

Call For Availability

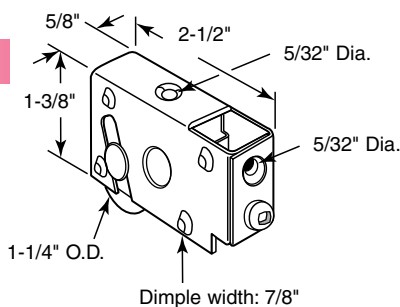

D-1807

Roller Housing

Contents: 1 roller housing.

Description: Steel outer housing; uses D-1619 inner housing; fits on **Empire Pacific®** and **Alwindor®** patio doors.

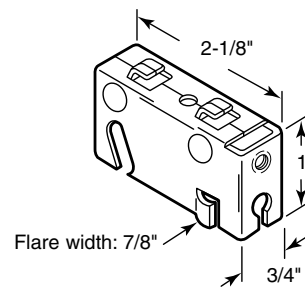

D-1618

Roller Assembly

Contents: 1 roller assembly.

Description: Steel ball bearing roller assembly; steel inner housing; uses D-1618 outer housing; fits on **Alwindor®** and **Empire Pacific®** patio doors.

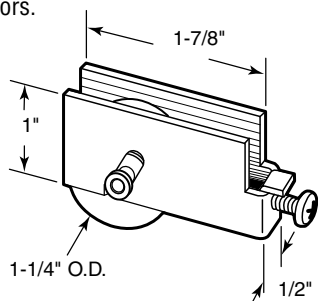

D-1619

Roller Assembly

Contents: 1 roller assembly.

Description: Steel ball bearing roller assembly; adjustable steel housing; fits on **Capitol®** doors.

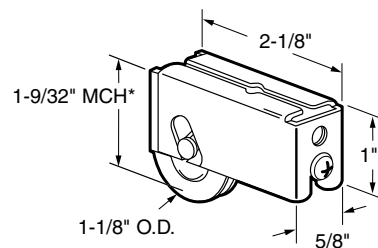

D-1596

Roller Assembly

Contents: 1 roller assembly.

Description: Nylon ball bearing roller assembly; adjustable steel housing; fits on **Regal®** and other patio door manufacturers.

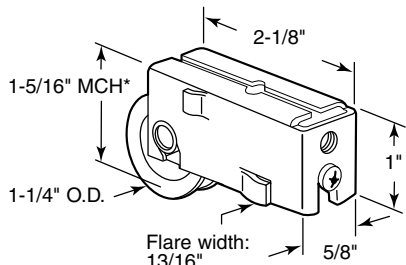

D-1536

Roller Assembly

Contents: 1 roller assembly.

Description: Ball bearing roller assembly; adjustable steel housing; fits on **Smith Carry®** and other patio door manufacturers.

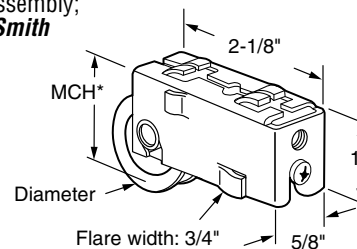

D-1848 (1-1/8" O.D. Steel - 1-1/4" MCH)

D-1535 (1-1/4" O.D. Nylon - 1-5/16" MCH)

D-1785 (1-1/4" O.D. Steel - 1-5/16" MCH)

Roller Assembly

Contents: 1 roller assembly.

Description: Steel ball bearing roller assembly; adjustable steel housing; fits on **Smith & Kelly**® doors and other patio door manufacturers.

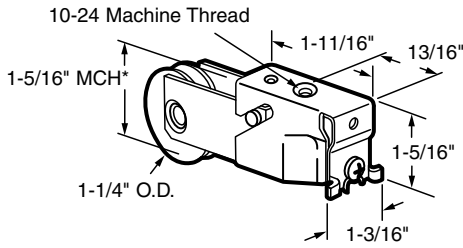

D-1560

Roller Assembly

Contents: 1 roller assembly.

Description: Ball bearing roller assembly; adjustable diecast housing; fits on **Fleetwood**® and **Fullview**® patio doors.

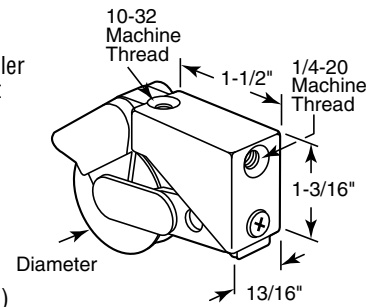

D-1620 (1-1/4" O.D. Nylon)
D-1532 (1-1/4" O.D. Steel)
D-1621 (1-1/2" O.D. Nylon)
D-1533 (1-1/2" O.D. Steel)
D-1533-SS (1-1/2" O.D. Stainless steel)

Roller Assembly

Contents: 1 roller assembly.

Description: Steel ball bearing roller assembly; adjustable diecast housing; used by several patio door manufacturers.



Used primarily in Canada

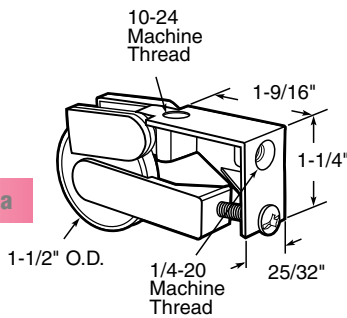

D-1934

Roller Assembly

Contents: 1 roller assembly.

Description: Steel ball bearing roller assembly; adjustable diecast housing; used by many patio door manufacturers.



Used primarily in Canada

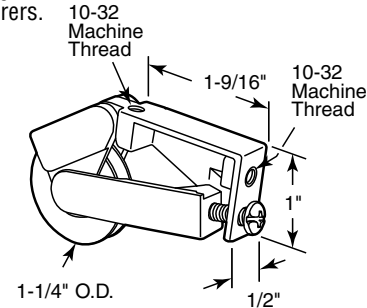

D-1794

Roller Assembly

Contents: 1 roller assembly.

Description: Steel ball bearing roller assembly; adjustable diecast housing; fits on "old style" **Acorn**® doors.

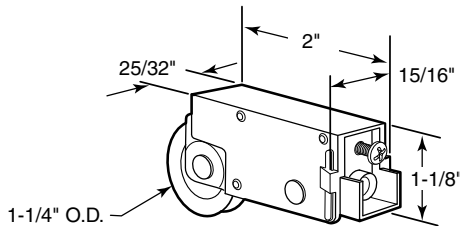

D-1842

Roller Assembly

Contents: 1 roller assembly.

Description: Steel ball bearing roller assembly; adjustable diecast housing; fits on **Crossly**® doors and other patio door manufacturers.

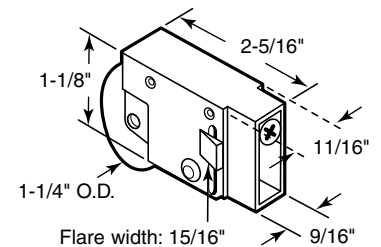

D-1603

Roller Assembly

Contents: 1 roller assembly.

Description: Steel ball bearing roller assembly; adjustable diecast housing; used by many patio door manufacturers.

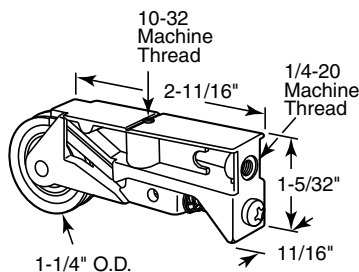

D-1640

Roller Assembly

Contents: 1 roller assembly.

Description: Steel ball bearing roller assembly; adjustable diecast housing; used by several patio door manufacturers.

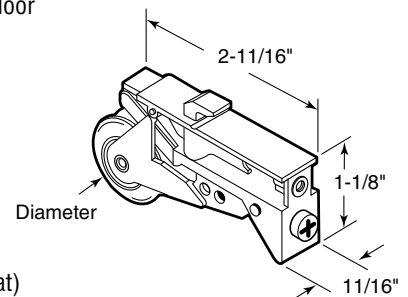

D-1962 (7/8" O.D. Flat)
D-1734 (1-1/4" O.D.)

Roller Assembly

Contents: 1 roller assembly.

Description: Ball bearing roller assembly; adjustable diecast housing; fits on *Trimview*® doors and many other manufacturers.

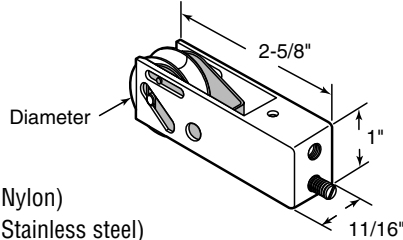

- D-1587** (1-1/4" O.D. Nylon)
- D-1932** (1-1/4" O.D. Stainless steel)
- D-1810** (1-1/2" O.D. Nylon)
- D-1825** (1-1/2" O.D. Steel)

Roller Housing

Contents: 1 roller housing.

Description: Diecast adjustable housing; no wheel; replace with D-1750.

Call For Availability

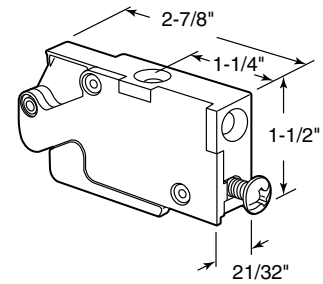

D-2001

Roller Assembly

Contents: 1 roller assembly.

Description: Flat roller assembly; adjustable diecast housing; used by several patio door manufacturers.

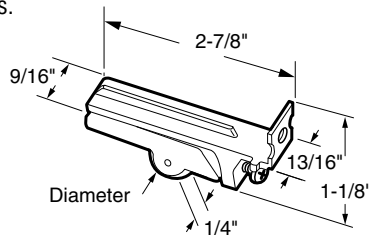

- D-1614** (5/8" O.D. Flat nylon with brass bushing)
- D-1613** (7/8" O.D. Flat steel ball bearing)

Roller Assembly

Contents: 1 roller assembly.

Description: Steel ball bearing roller assembly; steel roller housing.

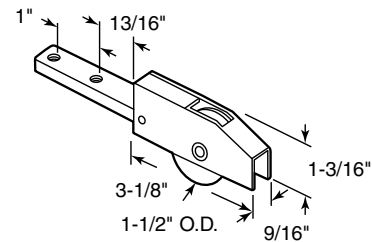

D-1893

Roller Assembly

Contents: 1 roller assembly.

Description: Nylon ball bearing roller assembly; adjustable diecast housing; fits on *Nudor*® doors and other patio door manufacturers.

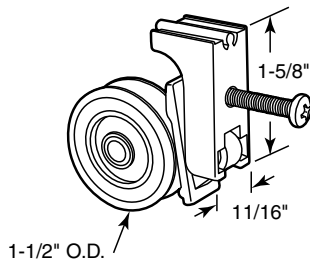

D-1550

Roller Assembly

Contents: 1 roller assembly.

Description: Nylon ball bearing roller assembly; adjustable diecast housing; fits on *Art Door*® patio doors.

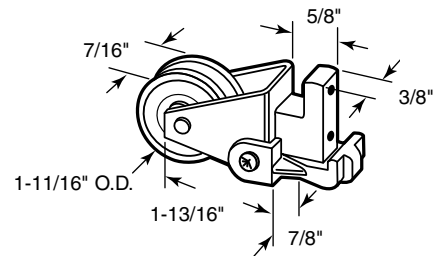

D-1555

Roller Assembly

Contents: 1 roller assembly.

Description: Steel ball bearing roller assembly; adjustable steel housing; used by several door manufacturers.

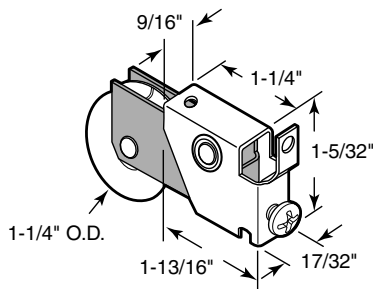

D-1906

Roller Assembly

Contents: 1 roller assembly.

Description: Ball bearing roller assembly; adjustable steel housing; used by several door manufacturers.

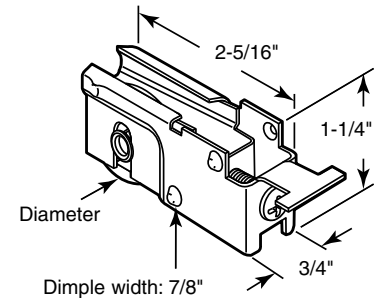

- D-1837** (1" O.D. Steel)
- D-1523** (1-1/8" O.D. Steel)
- D-1728** (1-1/4" O.D. Nylon)
- D-1923** (1-1/4" O.D. Steel)
- D-1789** (1-1/2" O.D. Nylon)
- D-1525** (1-1/2" O.D. Steel)

Roller Assembly

Contents: 1 roller assembly.

Description: Stainless steel ball bearing roller assembly; adjustable stainless steel housing; used by several door manufacturers.

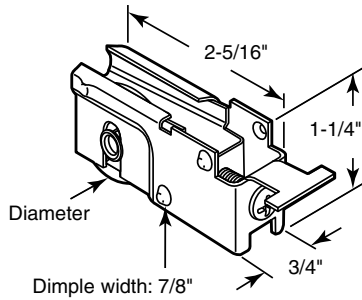

- D-1523-SS** (1-1/8" O.D.)
- D-1923-SS** (1-1/4" O.D.)
- D-1525-SS** (1-1/2" O.D.)

Roller Assembly

Contents: 1 roller assembly.

Description: Steel ball bearing roller assembly; adjustable steel housing; fits on *T.M Cobb*® and other patio door manufacturers.

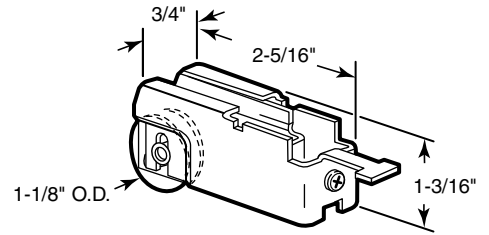

D-1524

Roller Assembly

Contents: 1 roller assembly.

Description: Steel ball bearing roller assembly; adjustable steel housing; used by several patio door manufacturers.

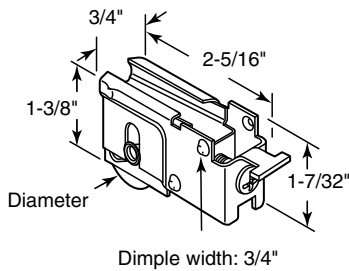

- D-1788** (1-1/8" O.D.)
- D-1878** (1-1/2" O.D.)

Roller Assembly

Contents: 1 roller assembly.

Description: Steel ball bearing roller assembly; adjustable steel housing; fits on *Solar Ind.*® and other patio door manufacturers.

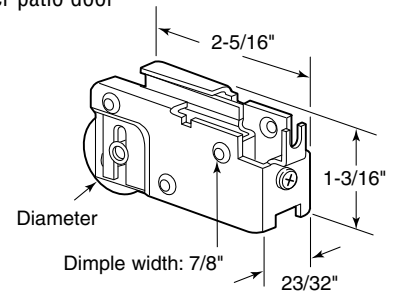

- D-1527** (1-1/8" O.D.)
- D-1526** (1-1/4" O.D.)

Roller Assembly

Contents: 1 roller assembly.

Description: Steel ball bearing roller assembly; adjustable steel housing; fits on *Northrop*® and other patio door manufacturers.

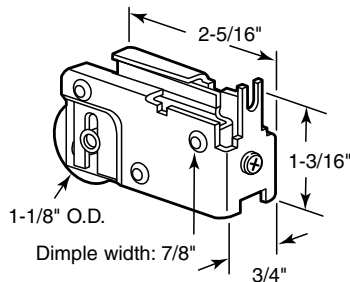

D-1529

Roller Assembly

Contents: 1 roller assembly.

Description: Steel ball bearing roller assembly; adjustable steel housing; used by several patio door manufacturers.

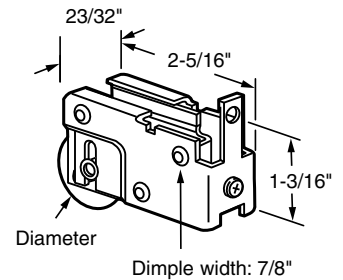

- D-1528** (1-1/8" O.D.)
- D-1925** (1-1/2" O.D.)

Roller Assembly

Contents: 1 roller assembly.

Description: Steel ball bearing roller assembly; adjustable steel housing; fits on *Northrop*® series 600 doors.

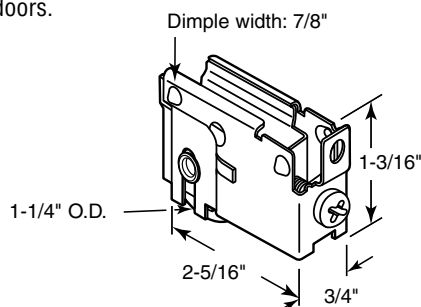

D-1811

Roller Assembly

Contents: 1 roller assembly.

Description: Steel ball bearing roller assembly; adjustable steel housing; fits on *Northrop*® and other patio door manufacturers.

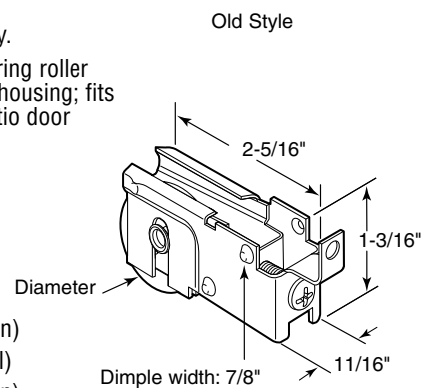

- D-1733** (1-1/4" O.D. Nylon)
- D-1584** (1-1/4" O.D. Steel)
- D-1929** (1-1/2" O.D. Nylon)
- D-1902** (1-1/2" O.D. Steel)

Roller Assembly

Contents: 1 roller assembly.

Description: Ball bearing roller assembly; adjustable steel housing; fits on *Lupton*® and other patio door manufacturers.

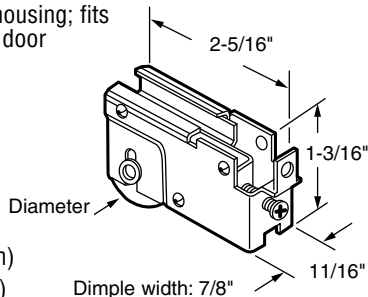

- D-1840** (1" O.D. Steel)
- D-1539** (1-1/4" O.D. Nylon)
- D-1918** (1-1/4" O.D. Steel)
- D-1974** (1-1/2" O.D. Nylon)
- D-1975** (1-1/2" O.D. Steel)

Roller Assembly

Contents: 1 roller assembly.

Description: Nylon ball bearing roller assembly; adjustable steel housing; used by several door manufacturers.

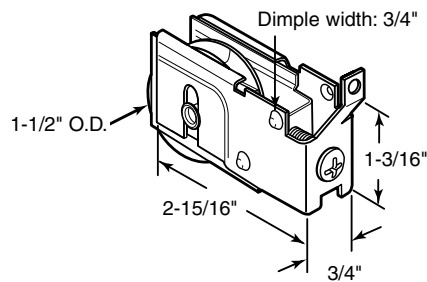

D-1737

Roller Assembly

Contents: 1 roller assembly.

Description: Steel ball bearing roller assembly; adjustable steel housing; fits on *Peachtree*® *Citation III* series patio doors.

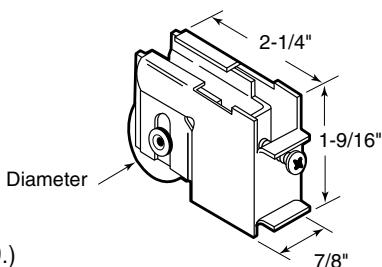

- D-1813** (1-1/8" O.D.)
- D-1611** (1-1/4" O.D.)

Roller Assembly

Contents: 1 roller assembly.

Description: Ball bearing roller assembly; steel housing; fits on *Arcadia*® doors and other patio door manufacturers.

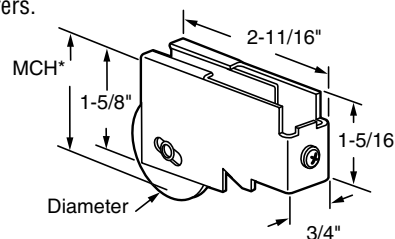

- D-1557** (1-11/16" O.D. Nylon - 2" MCH)
- D-1726** (1-13/16" O.D. Steel - 2-1/16" MCH)

Roller Assembly

Contents: 1 roller assembly.

Description: Ball bearing roller assembly; steel housing; fits on *Arcadia*® doors and other patio door manufacturers.

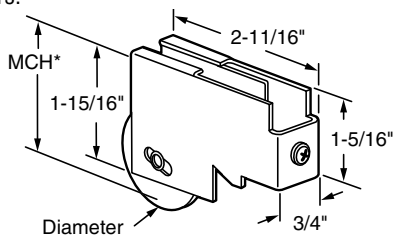

- D-1731** (1-11/16" O.D. Nylon - 2-1/4" MCH)
- D-1793** (1-13/16" O.D. Steel - 2-5/16" MCH)

Roller Assembly

Contents: 1 roller assembly.

Description: Ball bearing roller assembly; adjustable steel housing; fits on *Lumidor*®, *C.E. Stanley*® doors and other patio door manufacturers.

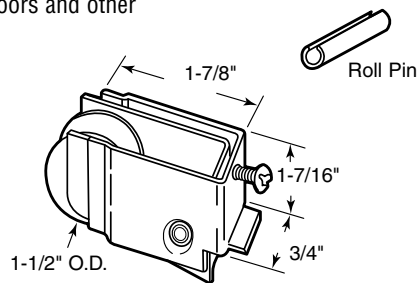

- D-1595** (Nylon)
- D-1749** (Steel)

Roller Assembly

Contents: 1 roller assembly.

Description: Ball bearing roller assembly; adjustable steel housing; fits on *International*® doors.

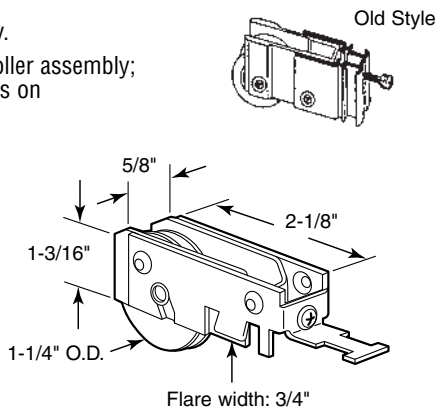

- D-1720** (Nylon)
- D-1518** (Steel)

Roller Assembly

Contents: 1 roller assembly.

Description: Stainless steel ball bearing roller assembly; adjustable stainless steel housing; ideal for use in corrosive conditions; fits on *International*® doors.

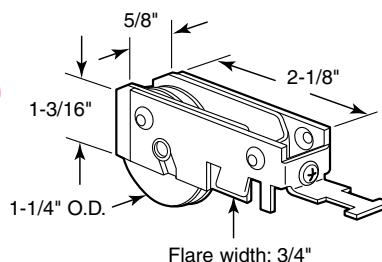

D-1518-SS

Roller Assembly

Contents: 1 roller assembly.

Description: Ball bearing roller assembly; adjustable aluminum housing; aluminum housing resist corrosion; fits on *International*® doors.

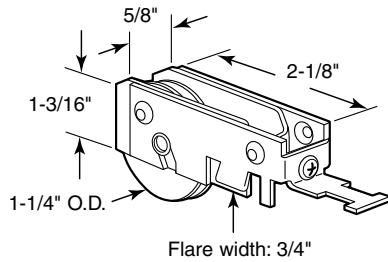

- D-1777** (Nylon)
- D-1778** (Stainless steel)

Roller Assembly

Contents: 1 roller assembly.

Description: Ball bearing roller assembly; adjustable steel housing; fits on *Window Master*® patio doors.

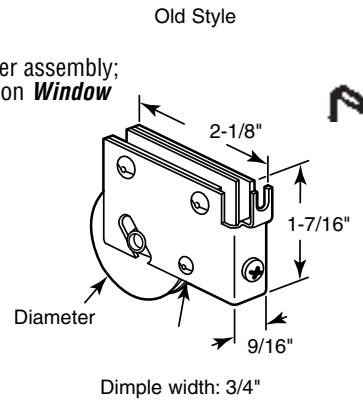

- D-1817** (1-1/4" O.D. Nylon)
- D-1756** (1-1/4" O.D. Steel)
- D-1589** (1-1/2" O.D. Nylon)
- D-1588** (1-1/2" O.D. Steel)

Roller Assembly

Contents: 1 roller assembly.

Description: Ball bearing roller assembly; adjustable steel housing; fits on *Doormaster*® and other patio door manufacturers.

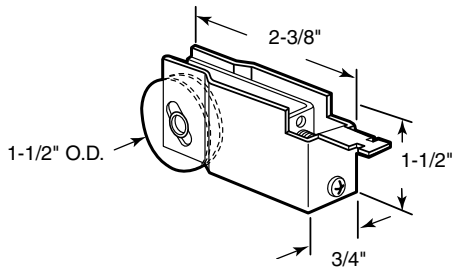

- D-1516** (Nylon)
- D-2039** (Steel)

Roller Assembly

Contents: 1 roller assembly.

Description: Ball bearing roller assembly; adjustable steel housing; used by several patio door manufacturers.

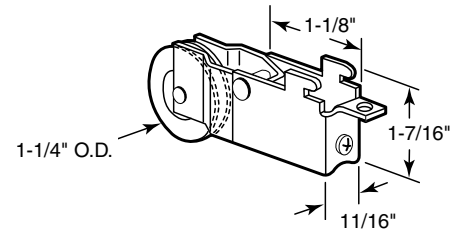

- D-1512** (Nylon)
- D-1886** (Steel)

Roller Assembly

Contents: 1 roller assembly.

Description: Ball bearing roller; adjustable steel housing; fits on *Ador Hilite*® patio doors; roller or housing can be bought separately.

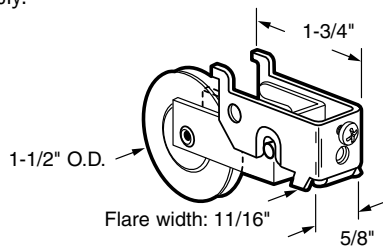

- D-1683** (Nylon)
- D-1685** (Steel)

Roller Assembly

Contents: 1 roller assembly.

Description: Ball bearing roller; steel mounting bracket; for use with D-1545 housing; combine to create D-1683 or D-1685.

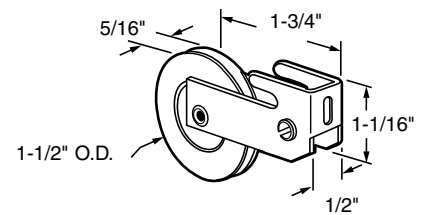

- D-1546** (Nylon)
- D-1585** (Steel)

Roller Housing

Contents: 1 roller housing.

Description: Steel housing for use with D-1546 or D-1585 roller; fits on *Ador Hilite*® patio doors; can be bought as a set, D-1683 or D-1685.

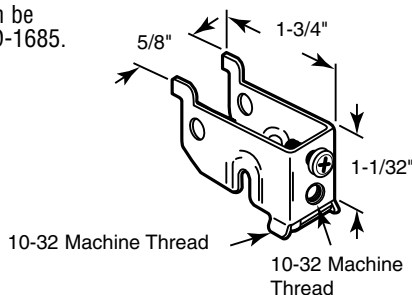

D-1545

Roller Assembly

Contents: 1 roller assembly.

Description: Steel ball bearing roller assembly; adjustable steel housing; used on *H & D Industries*® patio doors; housing can be bought separately, D-1543; D-1544 inner housing no longer available, use D-1546 or D-1585.

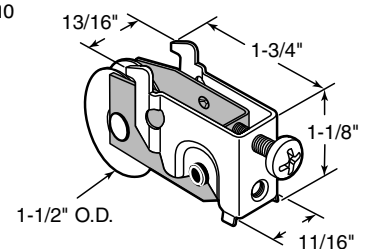

D-1853

Roller Housing

Contents: 1 roller housing.

Description: Steel housing for use with D-1544 roller, however, D-1544 inner housing is no longer available, use D-1546 or D-1585.; fits on **H & D Industries**® patio doors; can be bought as a set, D-1853.

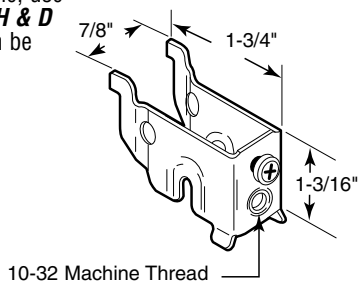

D-1543

Roller Assembly

Contents: 1 roller assembly.

Description: Ball bearing roller assembly; adjustable steel housing; fits on **Premier**® patio doors.

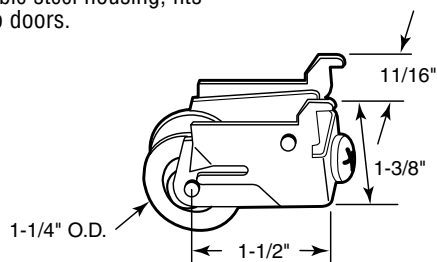

D-1522 (Nylon)

D-1752 (Steel)

Roller Assembly

Contents: 1 roller assembly.

Description: Stainless steel ball bearing roller assembly; adjustable stainless steel housing; fits on **Premier**® patio doors.

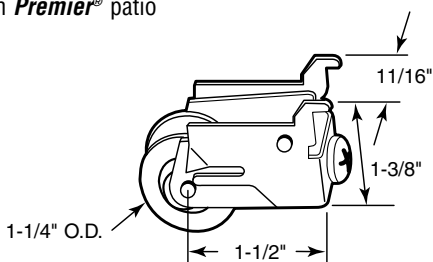

D-1752-SS

Roller Assembly

Contents: 1 roller assembly.

Description: Steel ball bearing roller assembly; adjustable steel housing; used by many patio door manufacturers.

Call For Availability

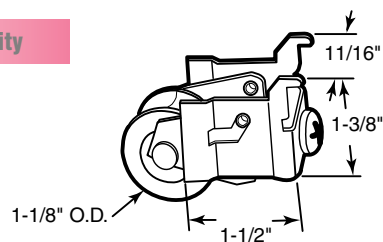

D-1715

Roller Assembly

Contents: 1 roller assembly.

Description: Steel ball bearing roller assembly; adjustable steel housing; used by many patio door manufacturers.

Call For Availability

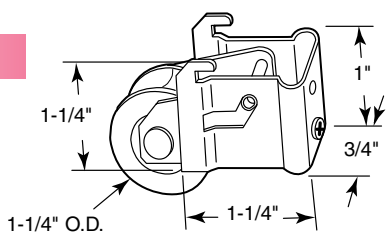

D-2004

Roller Assembly

Contents: 1 roller assembly.

Description: Steel ball bearing roller assembly; adjustable steel housing; fits on **Noranda Building Products**®, **Three Rivers Aluminum**® and **Bee Cee**® doors.

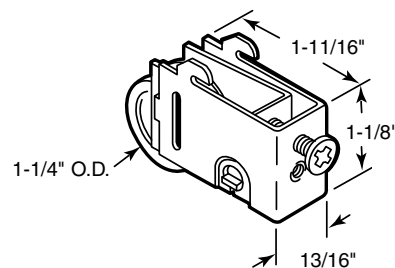

D-1687

Roller Assembly

Contents: 1 roller assembly.

Description: Ball bearing roller assembly; adjustable steel housing; fits on **Northrop**® patio doors.

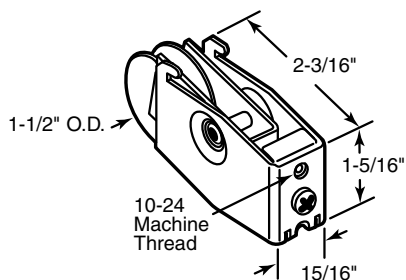

D-1556 (Nylon)

D-1950 (Steel)

Roller Assembly

Contents: 1 roller assembly.

Description: Steel ball bearing roller assembly; adjustable steel housing; fits on **Guaranteed Products**® and **The Jordan Company**® doors.

Call For Availability

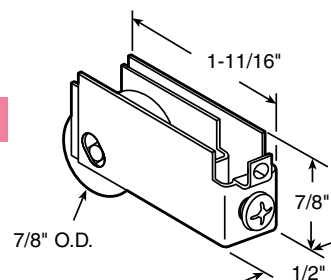

D-1776

Roller Assembly

Contents: 1 roller assembly.

Description: Nylon ball bearing roller assembly; adjustable steel housing; used by several patio door manufacturers.

Call For Availability

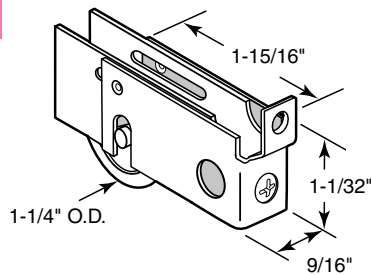

D-1898

Roller Assembly

Contents: 1 roller assembly.

Description: Steel ball bearing roller assembly; adjustable steel housing; fits on *Christian Porter*, *Fullview* and other patio door manufacturers.

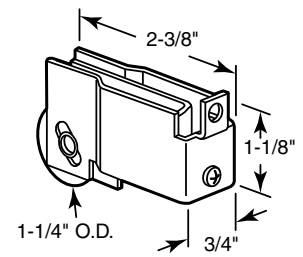

D-1515

Roller Assembly

Contents: 1 roller assembly.

Description: Nylon ball bearing roller; adjustable steel housing assembly; used by several patio door manufacturers.

Call For Availability

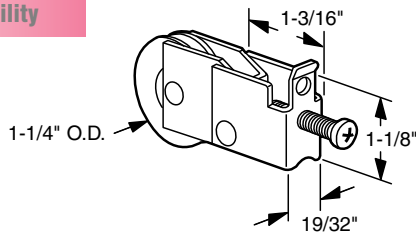

D-1508

Roller Assembly

Contents: 1 roller assembly.

Description: Nylon ball bearing roller assembly; adjustable steel housing; fits on *Ador HiLite* and other patio door manufacturers.

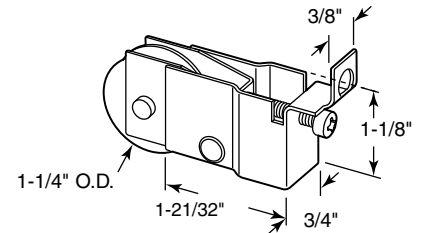

D-1521

Roller Assembly

Contents: 1 roller assembly.

Description: Nylon ball bearing roller assembly; adjustable steel housing; fits on *Ador HiLite* and other patio door manufacturers; original roller housing was made entirely out of nylon.

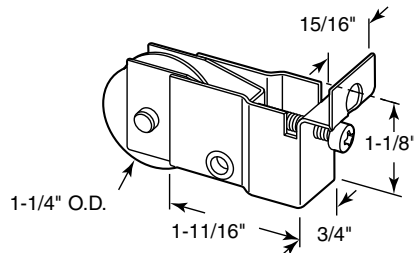

D-1520

Roller Assembly

Contents: 1 roller assembly.

Description: Steel ball bearing roller assembly; adjustable steel housing; fits on *Sun Valley*, *Fullview*, *Glasco* and other patio door manufacturers.

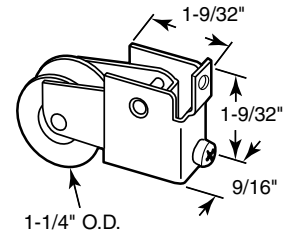
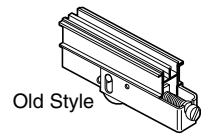

D-1509

Roller Assembly

Contents: 1 roller assembly.

Description: Nylon ball bearing roller assembly; adjustable steel housing; fits on *Rebco-West* doors.

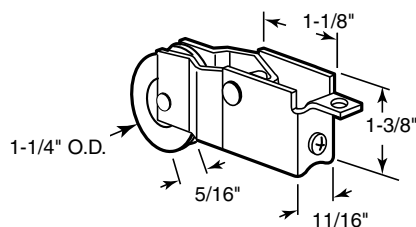

D-1513

Roller Assembly

Contents: 1 roller assembly.

Description: Ball bearing roller assembly; adjustable steel housing; fits on *Starlite*, *Doormaster* and other patio door manufacturers.

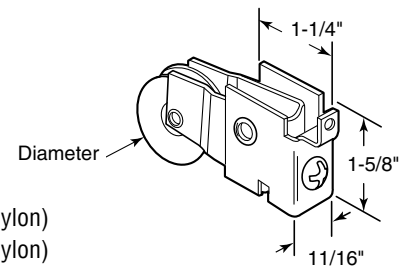

D-1510 (1-1/4" O.D. Nylon)

D-1511 (1-1/2" O.D. Nylon)

D-1772 (1-1/2" O.D. Steel)

Roller Assembly

Contents: 1 roller assembly.

Description: Ball bearing roller assembly; adjustable steel housing; fits on **Marshall**[®] and other patio door manufacturers.

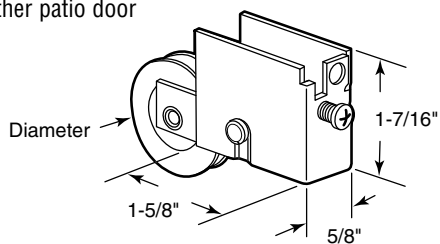

D-1931 (1-1/4" Stainless steel)

D-1558 (1-1/2" Nylon)

D-1976 (1-1/2" Steel)

Roller Assembly

Contents: 1 roller assembly.

Description: Steel ball bearing roller assembly; adjustable steel housing; fits on **Hollyview**[®], **Fullview**[®] and other patio door manufacturers.

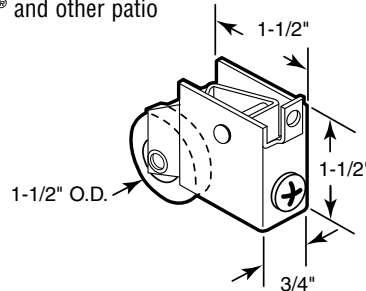

D-1531

Roller Assembly

Contents: 1 roller assembly.

Description: Steel ball bearing roller assembly; adjustable steel housing; used by several patio door manufacturers.

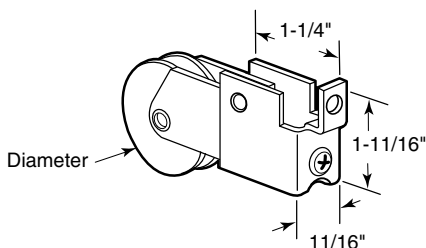

D-1578 (1-1/4" O.D.)

D-1790 (1-1/2" O.D.)

Roller Assembly

Contents: 1 roller assembly.

Description: Steel ball bearing roller assembly; adjustable steel housing; fits on **Schooner**[®] and other patio door manufacturers.

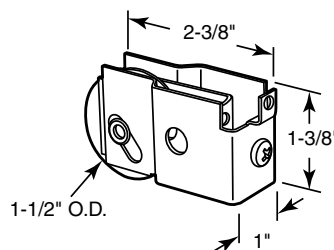

D-1530

Roller Assembly

Contents: 1 roller assembly.

Description: Steel ball bearing roller assembly; adjustable steel housing; fits on **Mid-Continent**[®] and other patio door manufacturers.

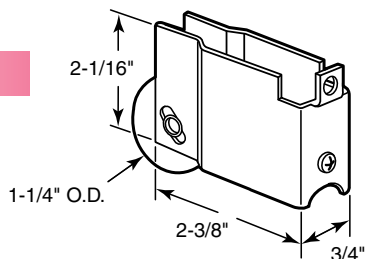

D-1517

Roller Assembly

Contents: 1 roller assembly.

Description: Flat steel ball bearing roller assembly; adjustable steel housing; fits on **Capitol**[®] doors.

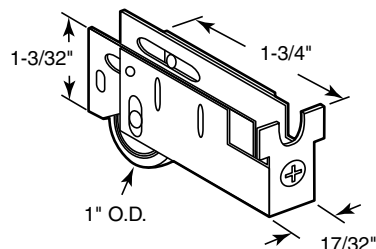

D-1774

Roller Assembly

Contents: 1 roller assembly.

Description: Ball bearing roller assembly; adjustable steel housing; used by several sliding door manufacturers.

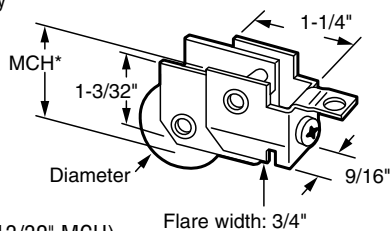

D-1696 (1-1/8" O.D. Steel - 1-13/32" MCH)

D-1698 (1-1/4" O.D. Nylon - 1-7/16" MCH)

D-1697 (1-1/4" O.D. Steel - 1-7/16" MCH)

D-1841 (1-1/2" O.D. Steel - 1-15/32" MCH)

Roller Assembly

Contents: 1 roller assembly.

Description: Ball bearing roller assembly; adjustable steel housing; used by several patio and mirror door manufacturers.

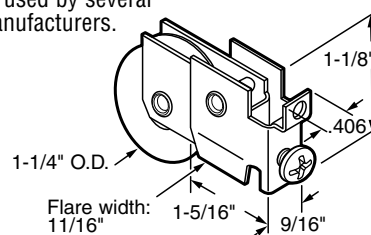

D-1936 (Nylon)

D-1686 (Steel)

Roller Assembly

Contents: 1 roller assembly.

Description: Ball bearing roller assembly; adjustable steel housing; inner and outer housings are held together with a flush pin (not a rivet); housing has smooth sides, no flares.

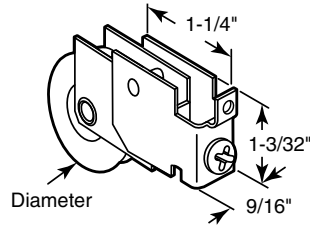

- D-1887** (1-1/4" O.D. Nylon)
- D-1773** (1-1/4" O.D. Steel)
- D-1879** (1-1/2" O.D. Nylon)

Roller Assembly

Contents: 1 roller assembly.

Description: Steel ball bearing roller assembly; adjustable steel housing; used by many mirror and wardrobe manufacturers.

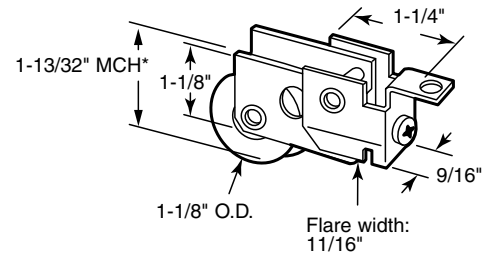

D-1812

Roller Assembly

Contents: 1 roller assembly.

Description: Steel ball bearing roller assembly; adjustable steel housing; used by many mirror and wardrobe manufacturers.

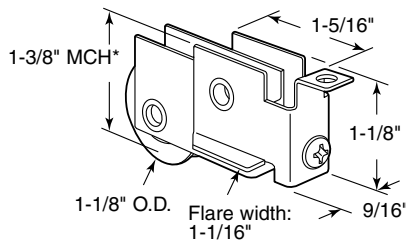

D-1909

Roller Assembly

Contents: 1 roller assembly.

Description: Ball bearing roller assembly; adjustable steel housing; fits on *King Mirror*® doors and other door manufacturers.

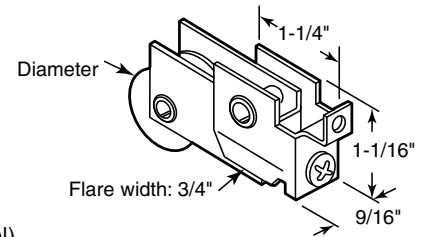

- D-1753** (1" O.D. Steel)
- D-1815** (1-1/4" O.D. Nylon)
- D-1740** (1-1/2" O.D. Steel)

Roller Assembly

Contents: 1 roller assembly.

Description: Steel ball bearing roller assembly; adjustable steel housing; fits on *Viking*® and other patio door manufacturers.

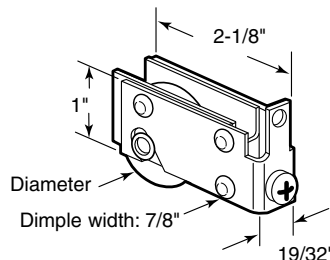

- D-1540** (1-1/8" O.D.)
- D-1729** (1-1/4" O.D.)

Roller Assembly

Contents: 1 roller assembly.

Description: Steel ball bearing roller assembly; adjustable steel housing; used by several patio door manufacturers.

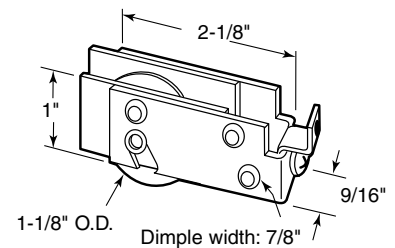

D-1699

Roller Assembly

Contents: 1 roller assembly.

Description: Ball bearing roller assembly; adjustable steel housing; fits on *Ador HiLite*® doors.

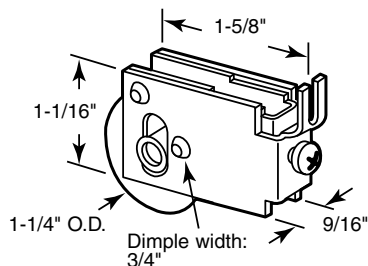

- D-1690** (Nylon)
- D-1691** (Steel)

Roller Assembly

Contents: 1 roller assembly.

Description: Steel ball bearing roller assembly; adjustable steel housing; fits on *Fullview*® patio doors.

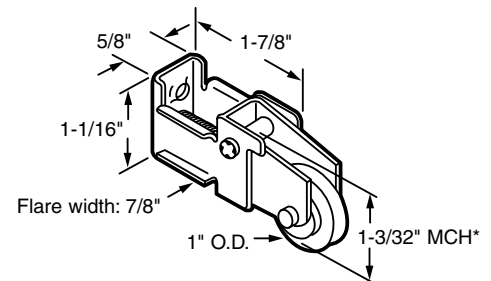

D-1590

Roller Assembly

Contents: 1 roller assembly.

Description: Steel ball bearing roller assembly; adjustable steel housing; fits on **Christian Porter**® and other patio door manufacturers.

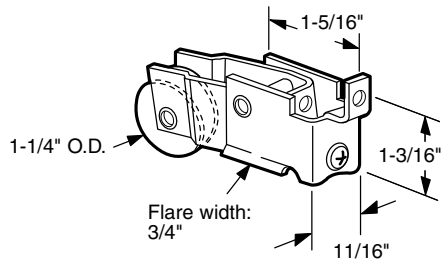

D-1514

Roller Assembly

Contents: 1 roller assembly.

Description: Steel ball bearing roller assembly; adjustable steel housing; fits **International**® doors.

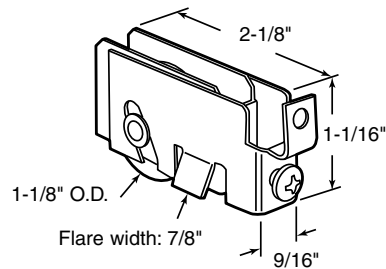

D-1942

Roller Assembly

Contents: 1 roller assembly.

Description: Steel ball bearing roller assembly; adjustable steel housing; fits **Rylock**® doors.

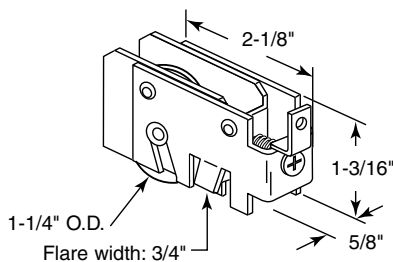

D-1856

Roller Assembly

Contents: 1 roller assembly.

Description: Ball bearing roller assembly; adjustable steel housing; used by several patio door manufacturers and will replace old style **Cupples**® door roller.

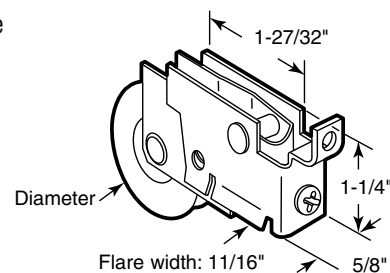

D-1978 (1-1/4" O.D. Nylon)

D-1519 (1-1/4" O.D. Steel)

D-1870 (1-1/2" O.D. Nylon)

D-1977 (1-1/2" O.D. Steel)

Roller Assembly

Contents: 1 roller assembly.

Description: Ball bearing roller assembly; adjustable steel housing; fits on **Window Master**® patio doors.

Old Style

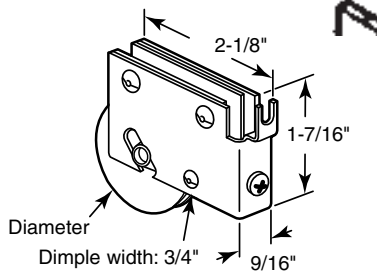

D-1817 (1-1/4" O.D. Nylon)

D-1756 (1-1/4" O.D. Steel)

D-1589 (1-1/2" O.D. Nylon)

D-1588 (1-1/2" O.D. Steel)

Roller Assembly

Contents: 1 roller assembly.

Description: Nylon ball bearing roller assembly; adjustable steel housing; used by several patio door manufacturers.

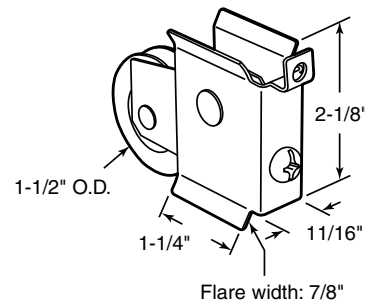

D-1905

Roller Assembly

Contents: 1 roller assembly.

Description: Nylon ball bearing roller; adjustable steel housing; fits on **Patio Enclosures**®.

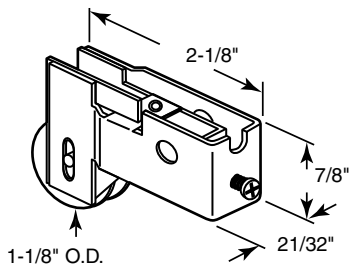

D-1771

Roller Assembly

Contents: 1 roller assembly.

Description: Steel ball bearing roller assembly; adjustable steel housing; fits on **Better-Bilt**® and other manufacturers.

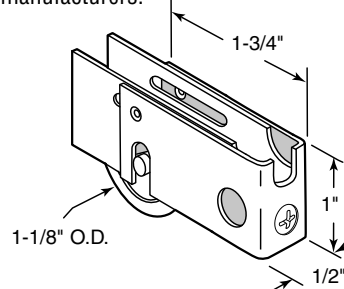

D-1758

Roller Assembly

Contents: 1 roller assembly.

Description: Ball bearing roller assembly; adjustable steel housing; fits on **Better-Bilt**® doors and other patio door manufacturers.

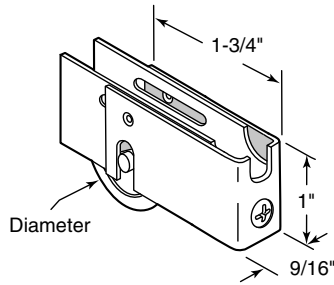

- D-1965** (1-1/8" O.D. Steel)
- D-1871** (1-1/4" O.D. Nylon)
- D-1768** (1-1/4" O.D. Steel)
- D-1873** (1-1/2" O.D. Nylon)
- D-1872** (1-1/2" O.D. Steel)

Roller Assembly

Contents: 1 roller assembly.

Description: Steel ball bearing roller assembly; adjustable steel housing; fits on **Daryl**® and other patio door manufacturers.

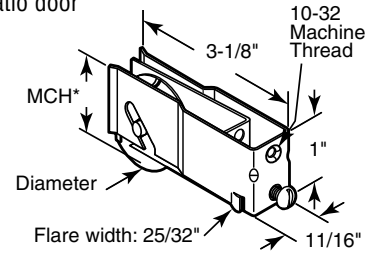

- D-1850** (1-1/4" O.D. - 1-1/4" MCH)
- D-1952** (1-1/2" O.D. - 1-5/16" MCH)

Roller Assembly

Contents: 1 roller assembly.

Description: Steel ball bearing roller; adjustable steel housing assembly; fits on **Capitol**® patio doors.

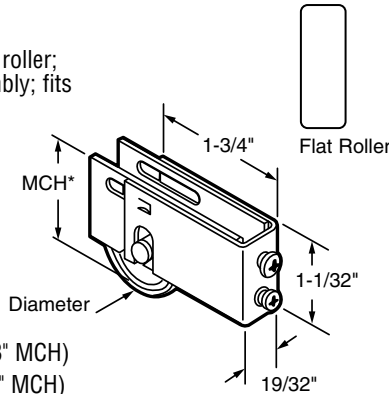

- D-1757** (1" O.D. - Flat - 1-1/8" MCH)
- D-1964** (1-1/8" O.D. - 1-3/16" MCH)
- D-1883** (1-1/4" O.D. - 1-1/4" MCH)

Roller Assembly

Contents: 1 roller assembly.

Description: Steel ball bearing roller assembly; adjustable steel housing; used by several patio door manufacturers.

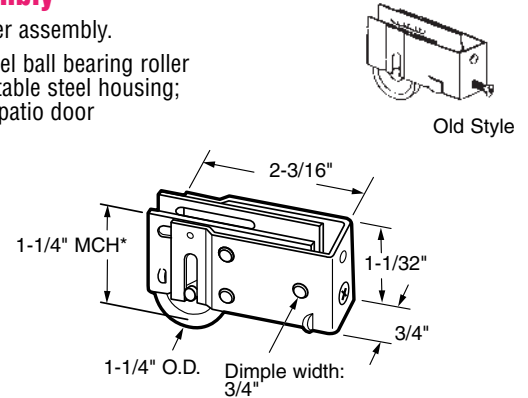

D-1707

Roller Assembly

Contents: 1 roller assembly.

Description: Steel ball bearing roller assembly; adjustable steel housing; used by several patio door manufacturers.

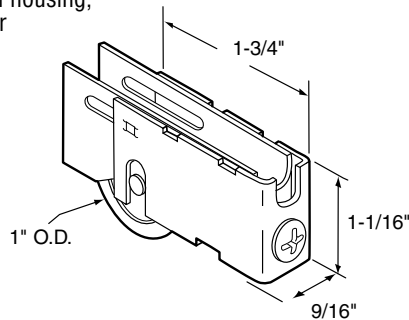

D-1829

Roller Assembly

Contents: 1 roller assembly.

Description: Steel ball bearing roller; adjustable steel housing assembly.

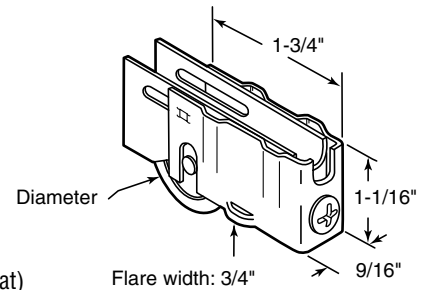

- D-1818** (1" O.D. - Flat)
- D-1755** (1-1/8" O.D.)

Roller Assembly

Contents: 1 roller assembly.

Description: Steel ball bearing roller assembly; adjustable steel housing; fits on **Crossly**® doors and other patio door manufacturers.

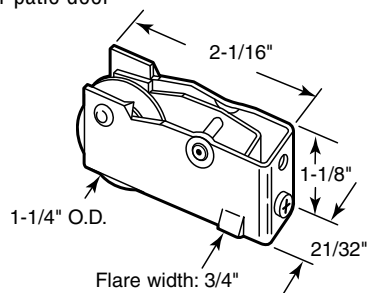

D-1601

Roller Assembly

Contents: 1 roller assembly.

Description: Steel ball bearing roller assembly; adjustable steel housing; fits on **Acorn**® and **Wells Aluminum**®.

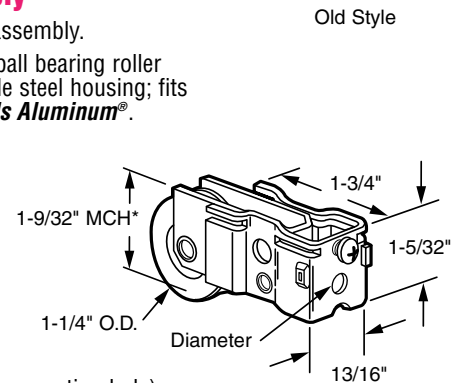

- D-1911** (.161 Dia. mounting hole)
- D-1559** (.228 Dia. mounting hole)

Roller Assembly

Contents: 1 roller assembly.

Description: Flat steel ball bearing roller assembly; adjustable steel housing; used by several patio door manufacturers.

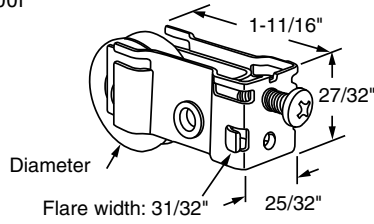

D-1889 (7/8" O.D. Flat - 1-9/32" MCH)

D-1890 (1-1/8" O.D. - 1-11/32" MCH)

Roller Assembly

Contents: 1 roller assembly.

Description: Flat steel ball bearing roller assembly; adjustable steel housing.

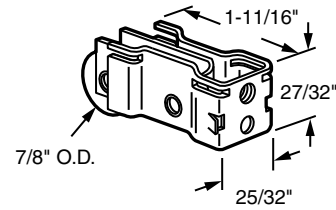

D-1963

Roller Assembly

Contents: 1 roller assembly.

Description: Steel ball bearing roller assembly; adjustable steel housing; used by several patio door manufacturers.

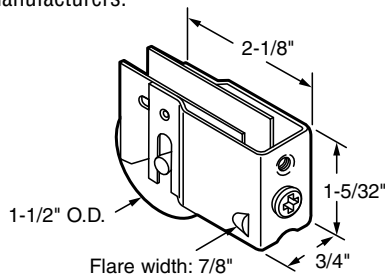

D-1826

Roller Assembly

Contents: 1 roller assembly.

Description: Steel ball bearing roller assembly; adjustable steel housing; fits on **Lausell Aluminum**® doors and other patio door manufacturers.

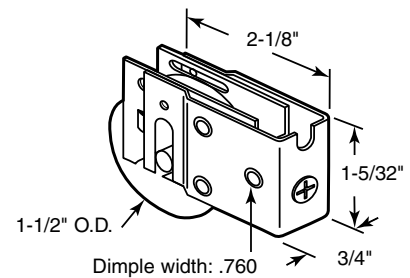

D-1781

Roller Assembly

Contents: 1 roller assembly.

Description: Steel ball bearing roller; adjustable steel housing assembly.

Call For Availability

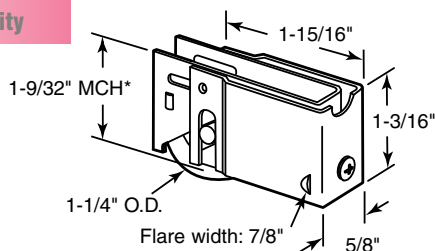

D-1819

Roller Assembly

Contents: 1 roller assembly.

Description: Steel ball bearing roller assembly; adjustable steel housing; fits on **Nu-Air**® doors and other patio door manufacturers.

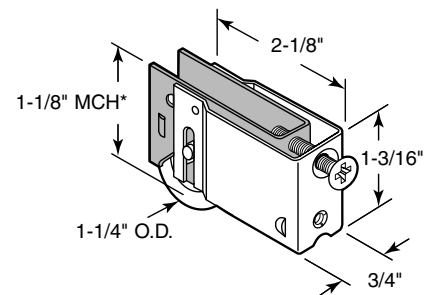

D-1762

Roller Assembly

Contents: 1 roller assembly.

Description: Steel ball bearing roller; adjustable steel housing assembly.

Call For Availability

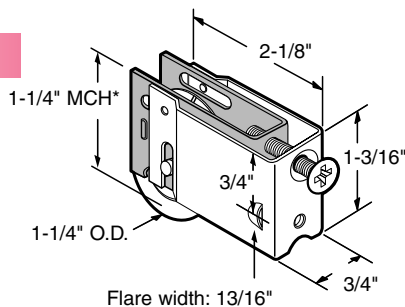

D-1823

Roller Assembly

Contents: 1 roller assembly.

Description: Steel ball bearing roller assembly; adjustable steel housing; fits on **Harcar**®, **Bee Cee**® doors and other patio door manufacturers.

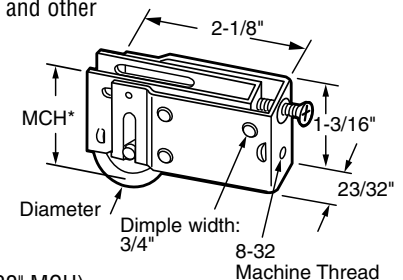

D-1708 (1-1/4" O.D. - 1-9/32" MCH)

D-1835 (1-1/2" O.D. - 1-15/32" MCH)

Roller Assembly

Contents: 1 roller assembly.

Description: Steel ball bearing roller assembly; adjustable steel housing; used by several patio door manufacturers.

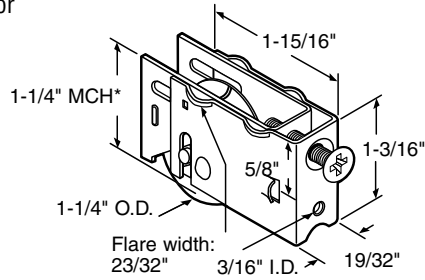

D-1820

Roller Assembly

Contents: 1 roller assembly.

Description: Steel ball bearing roller assembly; adjustable steel housing; fits on *Nu-Air*®, *Bennings*®, and *Scotty*® patio doors.

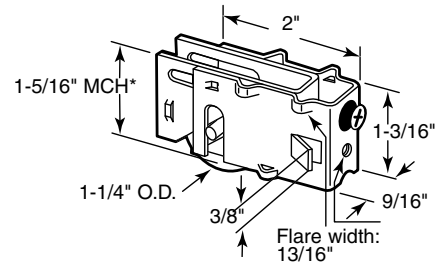

D-1688

Roller Assembly

Contents: 1 roller assembly.

Description: Ball bearing roller assembly; adjustable steel housing; used by several patio door manufacturers.

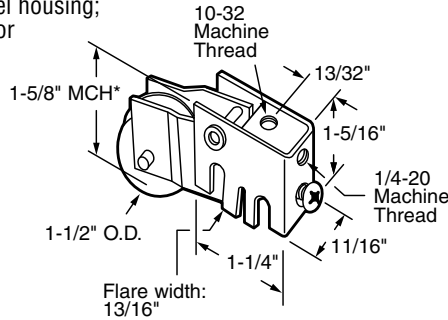

D-1805 (Nylon)
D-1534 (Steel)

Roller Assembly

Contents: 1 roller assembly.

Description: Ball bearing roller assembly; adjustable steel housing; fits on *Marshall Aluminum*® doors and other patio door manufacturers.

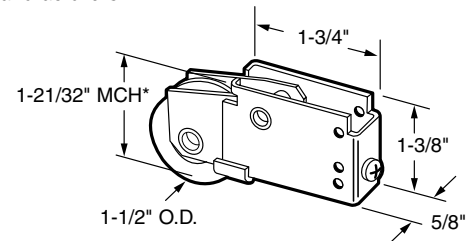

D-1599 (Nylon)
D-1901 (Steel)

Roller Assembly

Contents: 1 roller assembly.

Description: Steel ball bearing roller; adjustable steel housing; fits on *Harcar*®, *Bee Cee*® and other patio door manufacturers.

Call For Availability

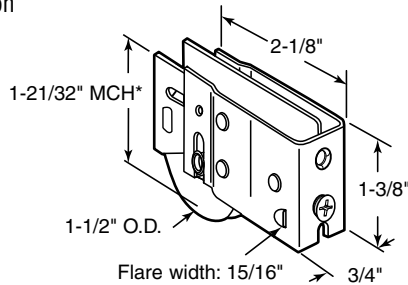

D-1770

Roller Assembly

Contents: 1 roller assembly.

Description: Steel ball bearing roller assembly; adjustable steel housing; fits on *Crown Manufacturing*® and *Penco*® doors.

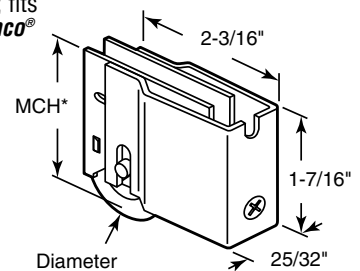

D-1782 (1-1/4" O.D. - 1-1/2" MCH)
D-1824 (1-1/2" O.D. - 1-5/8" MCH)

Roller Assembly

Contents: 1 roller assembly.

Description: Steel ball bearing roller assembly; adjustable steel housing; fits on several patio door manufacturers.

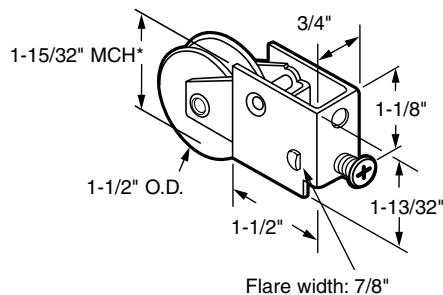

D-1608

Roller Assembly

Contents: 1 roller assembly.

Description: Steel ball bearing roller assembly; adjustable steel housing; used by several patio door manufacturers.

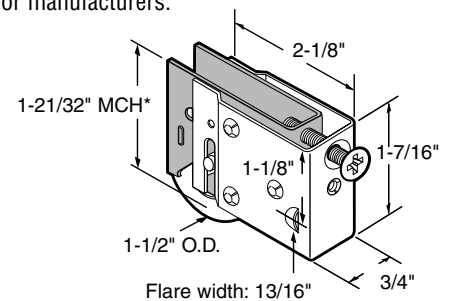

D-1828

Roller Assembly

Contents: 1 roller assembly.

Description: Steel ball bearing roller assembly; adjustable steel housing; fits on **Pan Am**® doors and other patio door manufacturers.

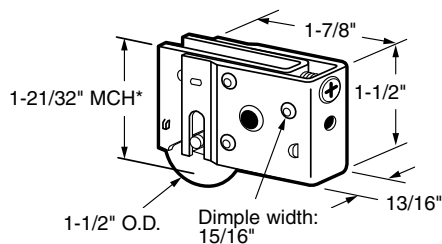

D-1763

Roller Assembly

Contents: 1 roller assembly.

Description: Steel ball bearing roller assembly; adjustable steel housing; used by several patio door manufacturers.

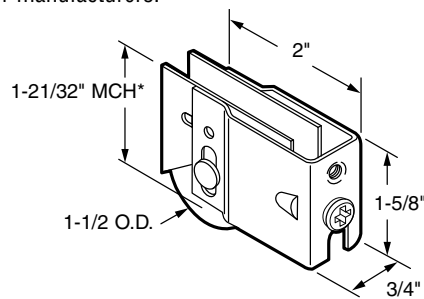

D-1751

Roller Assembly

Contents: 1 roller assembly.

Description: Steel ball bearing roller assembly; adjustable steel housing; fits on **Keller**® doors and other patio door manufacturers.

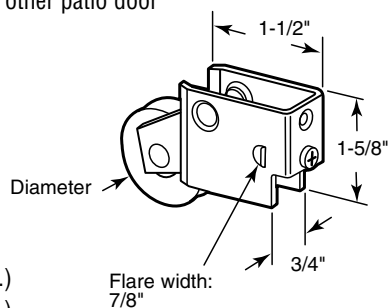

D-1561 (1-1/4" O.D.)
D-1562 (1-1/2" O.D.)

Roller Assembly

Contents: 1 roller assembly.

Description: Steel ball bearing roller assembly; adjustable steel housing; fits on **Keller** and other patio door manufacturers.

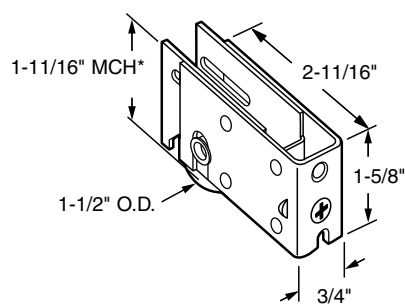

D-1759

Roller Assembly

Contents: 1 roller assembly.

Description: Steel ball bearing roller assembly; adjustable steel housing; used by several patio door manufacturers.

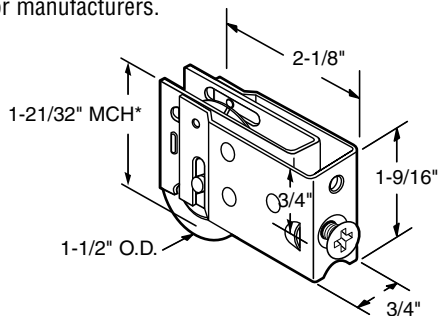

D-1822

Roller Assembly

Contents: 1 roller assembly.

Description: Ball bearing roller assembly; adjustable steel housing; fits on **Harcar**® doors and other patio door manufacturers.

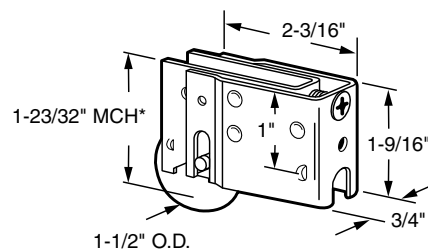

D-1930 (Nylon)
D-1600 (Steel)

Roller Assembly

Contents: 1 roller assembly.

Description: Steel ball bearing roller assembly; adjustable steel housing; used by several patio door manufacturers.

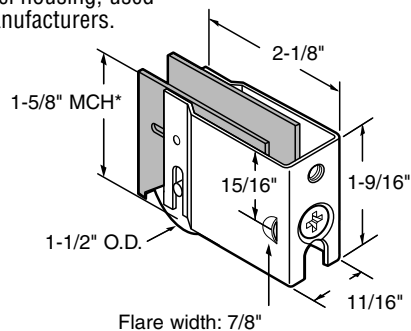

D-1830

Roller Assembly

Contents: 1 roller assembly.

Description: Stainless steel ball bearing roller assembly; adjustable stainless steel housing; used by several patio door manufacturers.

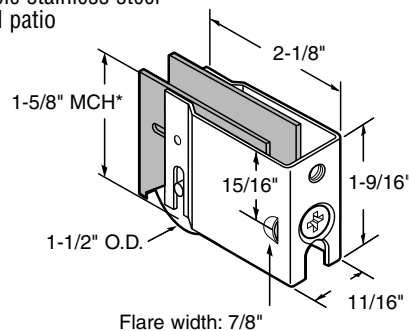

D-1830-SS

Roller Assembly

Contents: 1 roller assembly.

Description: Steel ball bearing roller assembly; adjustable steel housing; fits on **Crown Windows®** and other patio door manufacturers.

Call For Availability

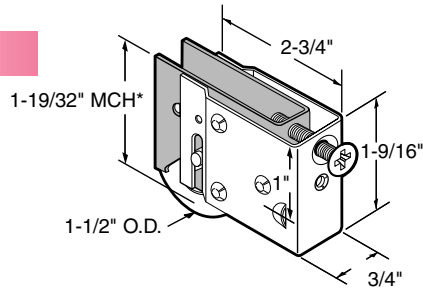

D-1761

Roller Assembly

Contents: 1 roller assembly.

Description: Steel ball bearing roller assembly; adjustable steel housing; used by several patio door manufacturers.

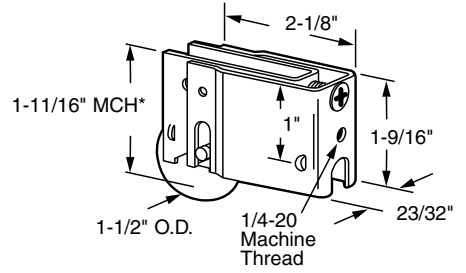

D-1949

Roller Assembly

Contents: 1 roller assembly.

Description: Ball bearing roller assembly; adjustable extruded aluminum housing; fits on **Miller®** Industries and other patio door manufacturers.

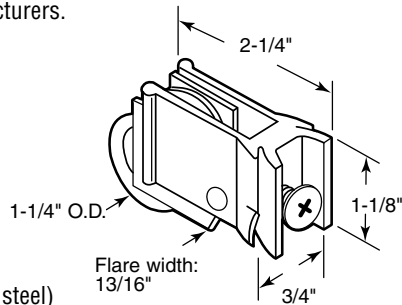

D-1602 (Steel)
D-1969-SS (Stainless steel)

Roller Assembly

Contents: 1 roller assembly.

Description: Ball bearing roller assembly; adjustable extruded aluminum housing; used by several door manufacturers.

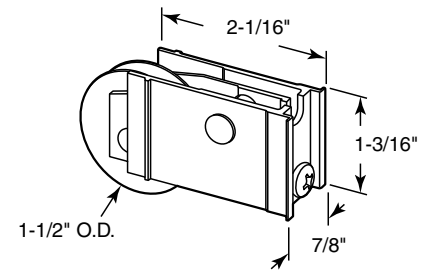

D-1955 (Nylon)
D-1863 (Steel)

Roller Assembly

Contents: 1 roller assembly.

Description: Steel ball bearing roller assembly; adjustable extruded aluminum housing; used by several door manufacturers.

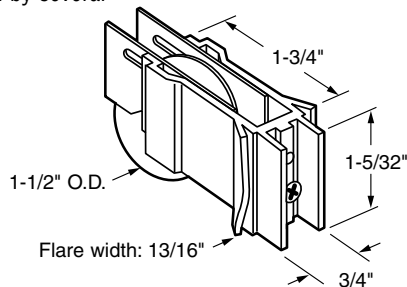

D-1767

Roller Assembly

Contents: 1 roller assembly.

Description: Steel ball bearing roller assembly; adjustable extruded aluminum housing; used by several door manufacturers.

Call For Availability

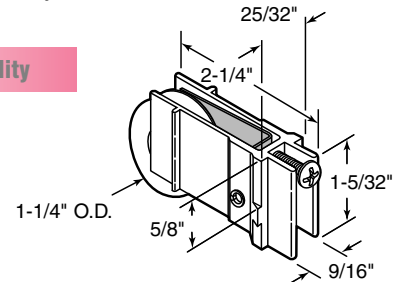

D-1885

Roller Assembly

Contents: 1 roller assembly.

Description: Steel ball bearing roller assembly; adjustable extruded aluminum housing; used by several door manufacturers.

Call For Availability

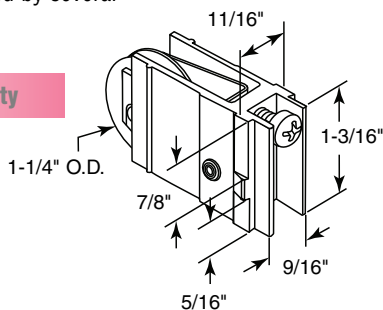

D-1958

Roller Assembly

Contents: 1 roller assembly.

Description: Ball bearing roller assembly; adjustable extruded aluminum housing; used by several door manufacturers.

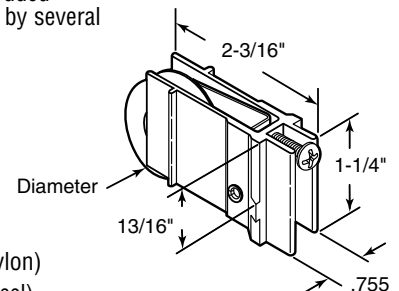

D-1953 (1-1/4" O.D. Nylon)
D-1732 (1-1/4" O.D. Steel)
D-1912 (1-1/2" O.D. Steel)

Roller Assembly

Contents: 1 roller assembly.

Description: Steel ball bearing roller assembly; adjustable extruded aluminum housing; used by several door manufacturers.

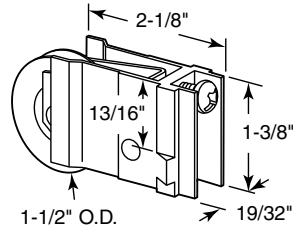

D-1960

Roller Assembly

Contents: 1 roller assembly.

Description: Steel ball bearing roller assembly; adjustable extruded aluminum housing; fits on *Pan American*[®], *AAA Aluminum*[®] and other patio door manufacturers.

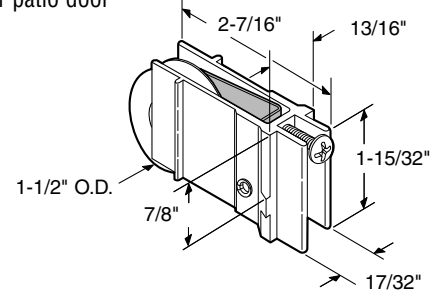

D-1598

Roller Assembly

Contents: 1 roller assembly.

Description: Nylon ball bearing roller assembly; adjustable extruded aluminum housing; used by several door manufacturers.

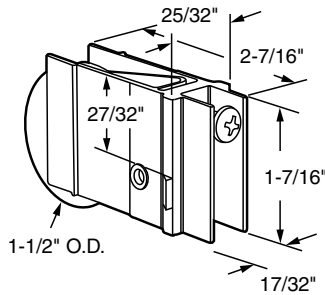

D-1769

Roller Assembly

Contents: 1 roller assembly.

Description: Ball bearing roller assembly; adjustable extruded aluminum housing; fits on *Lawson*[®] doors.

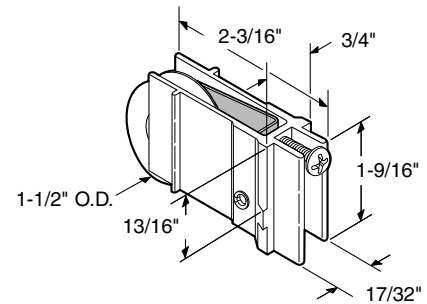

D-1954 (Nylon)
D-1956 (Steel)

Roller Assembly

Contents: 1 roller assembly.

Description: Steel ball bearing roller assembly; adjustable extruded aluminum housing; used by several door manufacturers.

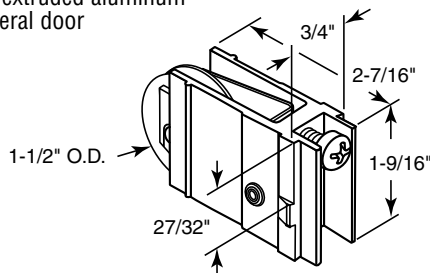

D-1959

Roller Assembly

Contents: 1 roller assembly.

Description: Nylon ball bearing roller assembly; adjustable extruded aluminum housing; used by several door manufacturers.

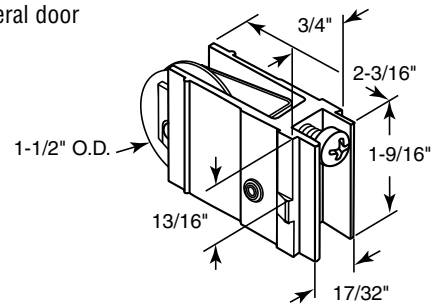

D-1961

Roller Assembly

Contents: 1 roller assembly.

Description: Ball bearing roller assembly; adjustable extruded aluminum housing; fits on *Peachtree*[®] "Command 5" series doors.

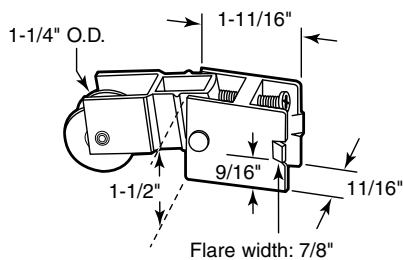

D-1967 (Nylon)
D-1616 (Steel)

Roller Assembly

Contents: 1 roller assembly.

Description: Steel ball bearing roller assembly; adjustable extruded aluminum housing; fits on *Peachtree*[®] "Citation 2" single glazed doors.

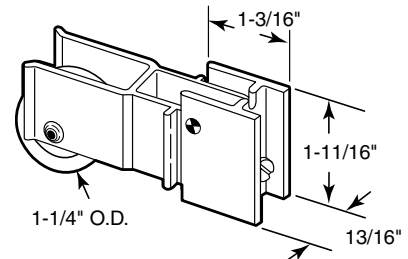

D-1610

Roller Assembly

Contents: 1 roller assembly.

Description: Steel ball bearing roller assembly; adjustable extruded aluminum housing; fits on **Peachtree®** "Citation 2" single glazed doors.

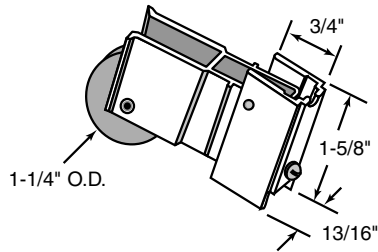

D-1609

Roller Assembly

Contents: 1 roller assembly.

Description: Nylon ball bearing roller assembly; adjustable extruded aluminum housing; fits on **Daryl®**, **Plaza Door®** and other patio door manufacturers.

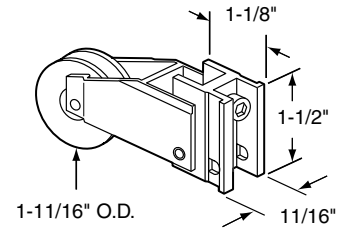

D-1591

Roller Assembly

Contents: 1 roller assembly.

Description: Nylon ball bearing roller assembly; extruded aluminum housing; nylon track cleaner; fits on **Alcan®** patio doors.

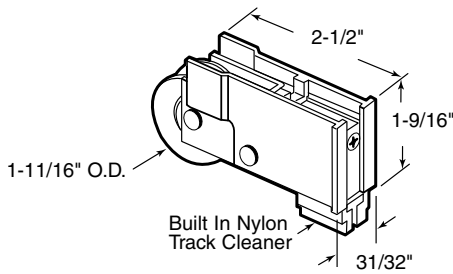

D-1764

Roller Assembly

Contents: 1 roller assembly.

Description: Nylon ball bearing roller; aluminum housing; fits on **Western®** patio doors.

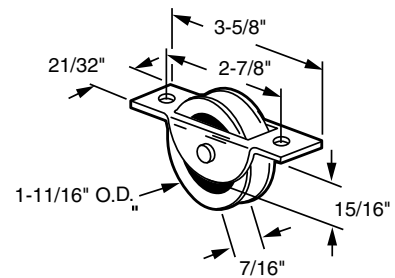

D-1564

Roller Assembly

Contents: 1 roller assembly.

Description: Steel ball bearing roller assembly; steel housing; fits on **Silverline®**.

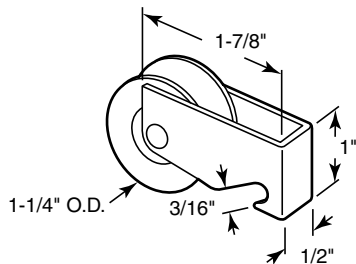

D-1966

Roller Assembly

Contents: 1 roller assembly.

Description: Nylon ball bearing roller assembly; diecast housing.

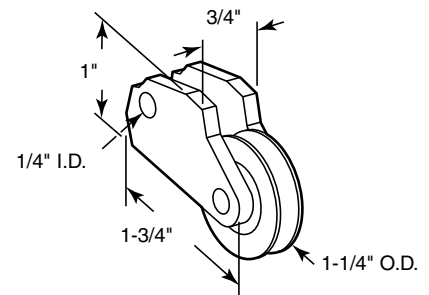

D-1970

Roller Assembly

Contents: 1 roller assembly.

Description: Steel ball bearing roller; stamped steel housing; use with D-1560 to replace inner roller assembly.

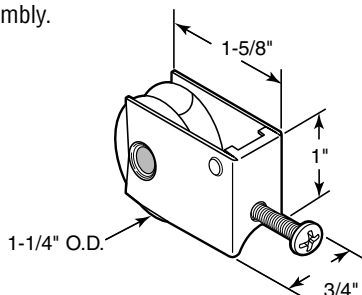

D-1836

Roller Assembly

Contents: 1 roller assembly.

Description: Steel ball bearing roller assembly; steel housing.

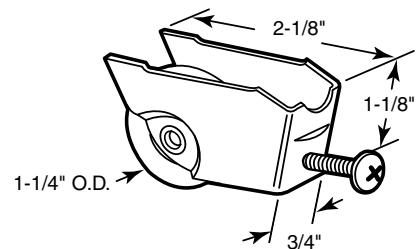

D-1721

Roller Assembly

Contents: 1 roller assembly.

Description: Nylon roller with bushing axle; non-adjustable nylon housing; fits on *Likit*® patio doors.

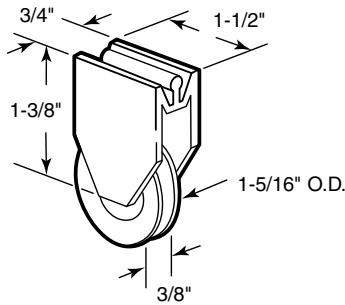

D-1565

Roller Assembly

Contents: 1 roller assembly.

Description: Steel ball bearing roller assembly; plastic housing.

Call For Availability

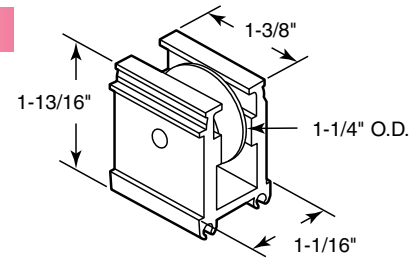

D-1968

Roller Assembly

Contents: 1 roller assembly.

Description: N

Call For Availability

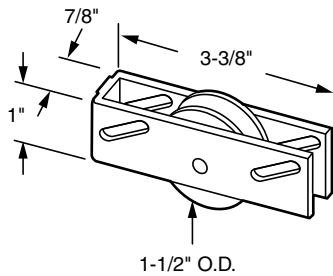

D-1972

Roller Assembly

Contents: 1 roller assembly.

Description: Steel ball bearing roller assembly; steel housing (side plate on each side of bearing); steel gear with adjustment screws.

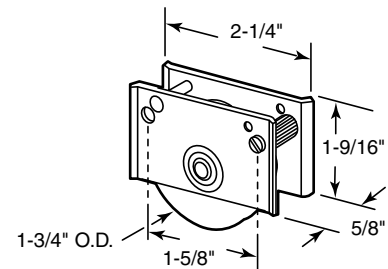

D-1637

Roller Assembly

Contents: 1 roller assembly.

Description: Ball bearing roller assembly; adjustable steel inner housing; fits on *Capitol Door*® products.

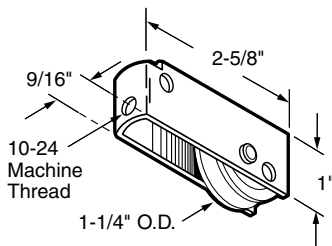

D-1617 (Nylon)

D-1892 (Steel)

Roller Assembly

Contents: 1 roller assembly.

Description: Steel ball bearing roller assembly; galvanized steel housing.

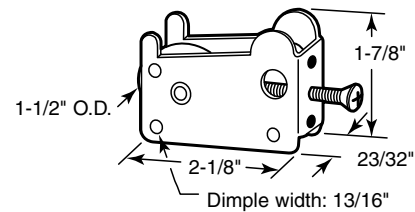

D-1722

Bumper

Contents: 2 bumpers, installation fasteners.

Description: Rubber bumper mounted on steel "L" bracket; universal design.

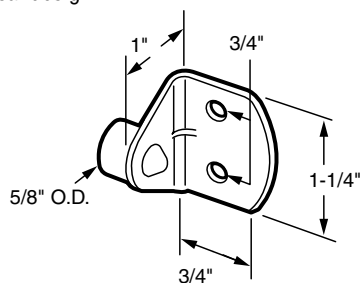

D-1702

Bumper

Contents: 4 bumpers, installation fasteners.

Description: Rubber bumper; reduces damage and noise; used by many manufacturers.

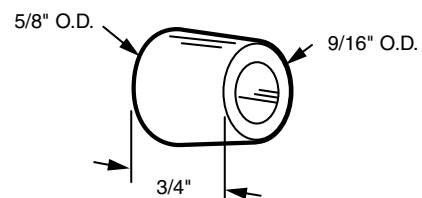

D-1714