

Section 2 COMBINATION SILL-THRESHOLDS

<p>Standard Sizes: 30", 32", 36", 42", 48", 60", 64", 72" (cut exact).</p> <p>Other lengths are available. (Extra cost over 73") Drop In Sills are cut to exact length ordered.</p> <p>Center holes are countersunk, 1 per door for routed nail-on sill; or, approximately 1 per 12" for drop-in sill. Sills can be ordered without center holes, if desired.</p>	<p>Special fabrications to ease installation with ordering information are described on page 14:</p> <ul style="list-style-type: none"> Rout for nail-on jambs (3/8" - 1-1/4") Mullion rout (MR) Rout for metal/mortised frame (RMF) Sill trim notch (SN) Nail-on rabbet <p>#10 phillips flathead screws are included, length per industry standard.</p>	<p>All Sills can be packaged with any door bottom to create a packaged set.</p> <p>Sill Covers and Sill Risers are on page 17.</p> <p>Special anchors for concrete are available at extra cost, see page 34.</p> <p>End Holes are provided with sills routed for nail-on jambs.</p>
---	---	---

SILL-THRESHOLD SELECTION GUIDE

PRODUCT #	WIDTH	HEIGHT	SLOPE	JAMB WIDTH
542	4⁹/₁₆"	1¹/₈"	6°	4¹/₈ to 5
650	5³/₄"	1¹/₈"	9°	4³/₈ to 5¹/₂
569	5⁵/₈"	1¹/₄"	6°	4³/₈ to 5¹/₂
775	7³/₄"	1¹/₄"	9°	6 to 7¹/₈
520	5⁵/₈"	1³/₈"	5°	4³/₈ to 5¹/₂
522	7³/₄"	1³/₈"	5°	6 to 7¹/₈
585	5¹/₈"	1³/₈"	9°	4 to 4⁷/₈
680	6¹³/₁₆"	1³/₈"	9°	5¹/₂ to 6¹/₂

NOTE: Each profile also available for continuous level floor.

THERMAL-BREAK THRESHOLD

Thermal-Break Threshold for Modular Homes (#520 & #522). Heavy wall thickness for strength and rigidity. Screw-bosses for attaching to frame (fasteners not included). End Seals available.

520 A

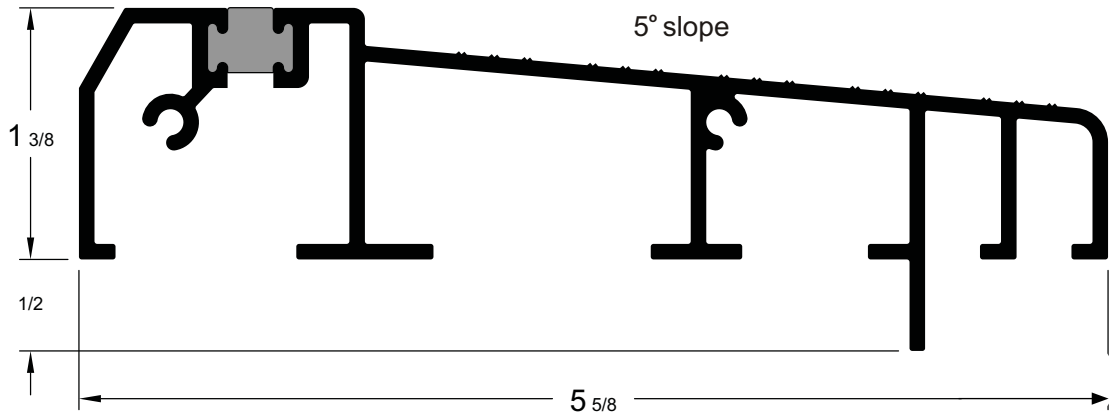

522 A

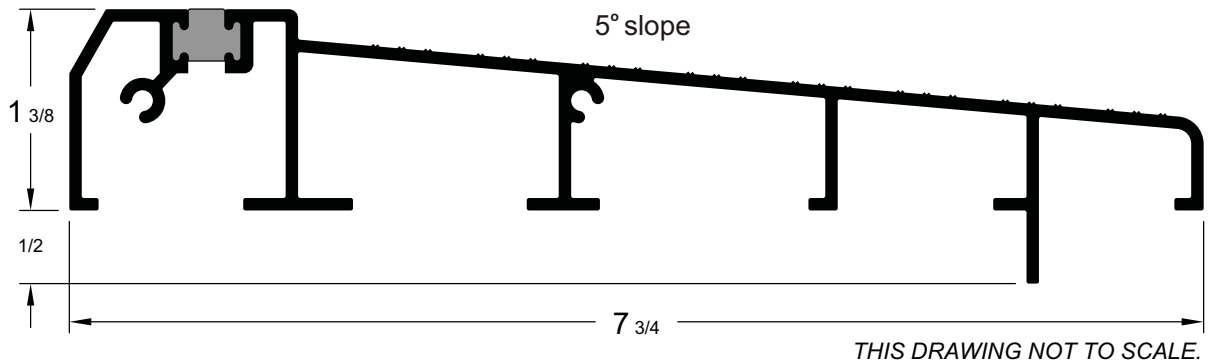

THIS DRAWING NOT TO SCALE.

INSERT SILL-THRESHOLD

COMPOSITE & WOOD SUBSTRATE AVAILABLE

542 A, B

For jambs:
4-1/8" to 5" wide.
For doors 1-3/4" and over
**Will accept extenders
834 and 836
shown on page 27.**

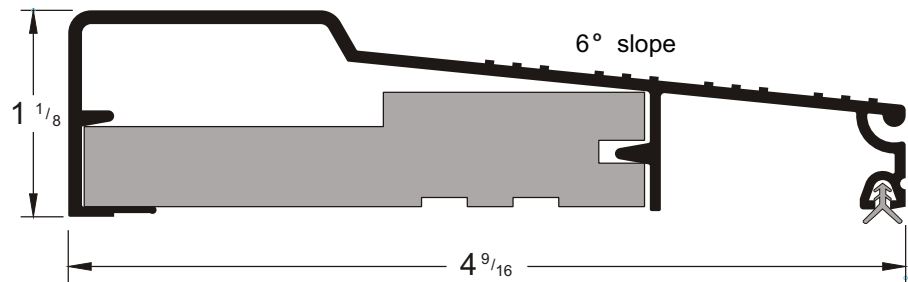

Full length wood or composite insert for glue down or nail-on applications

▽ Indicates location of standard fastener hole.

**PRODUCTS ARE SHOWN ACTUAL SIZE
(EXCEPT AS NOTED)**

“COMBO SILLS”

564 A

For jambs:
4-1/8" to 5" wide.

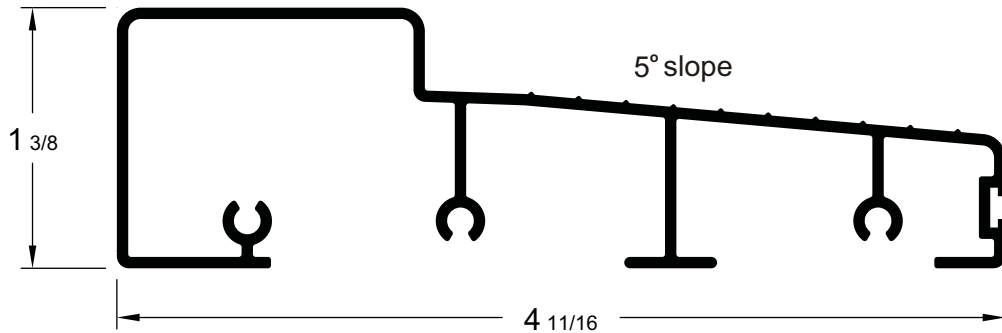

566 A

For jambs:
5-1/2" to 6-1/2" wide.

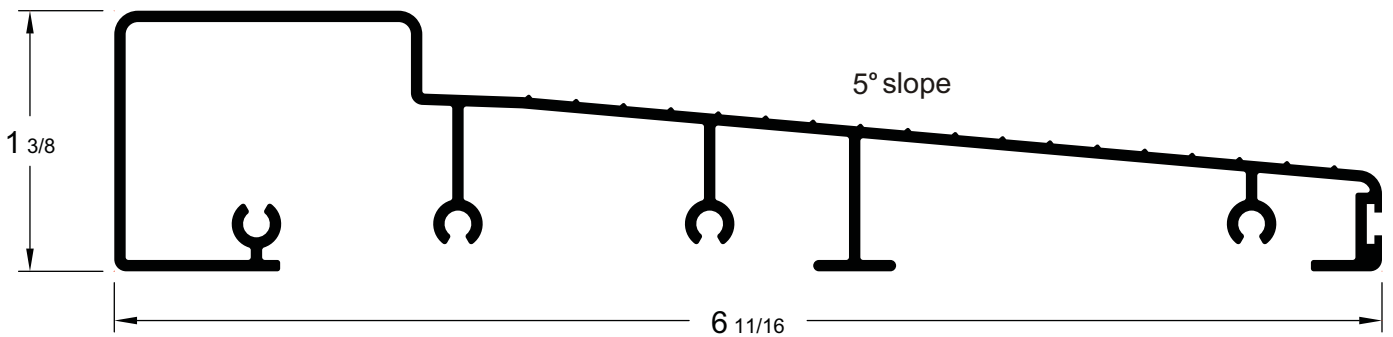

569 B

For jambs:
4-3/8" to 5-1/2" wide.

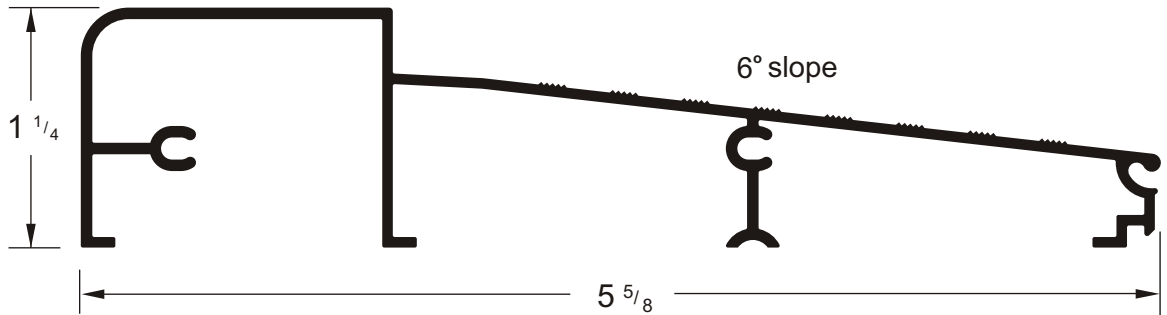

585 A, B

For jambs:
4" to 4-7/8" wide;
For doors 1-3/4" and
over. 10 x 2-1/2" phillips
flathead screws
are included.

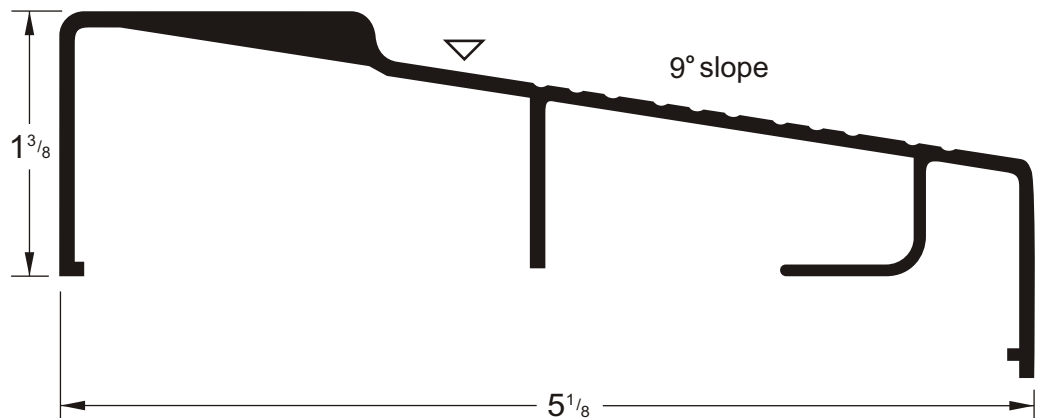

▽ Indicates location of standard fastener hole.

586 A, B

For jambs:
4" to 4-7/8" wide &
continuous level floor.
For doors 1-3/4" and
over. 10 x 2-1/2" phillips
flathead screws are included.

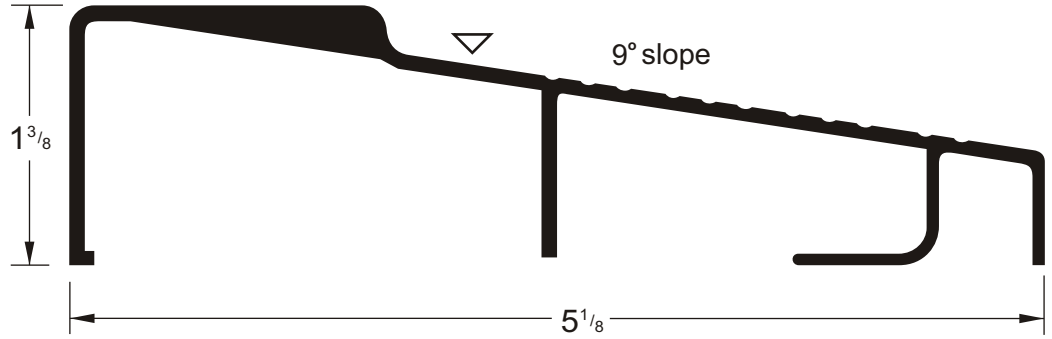

650 A, B

For jambs:
4-3/8" to 5-1/2"
wide. 10 X 2"
phillips flathead
screws are included.

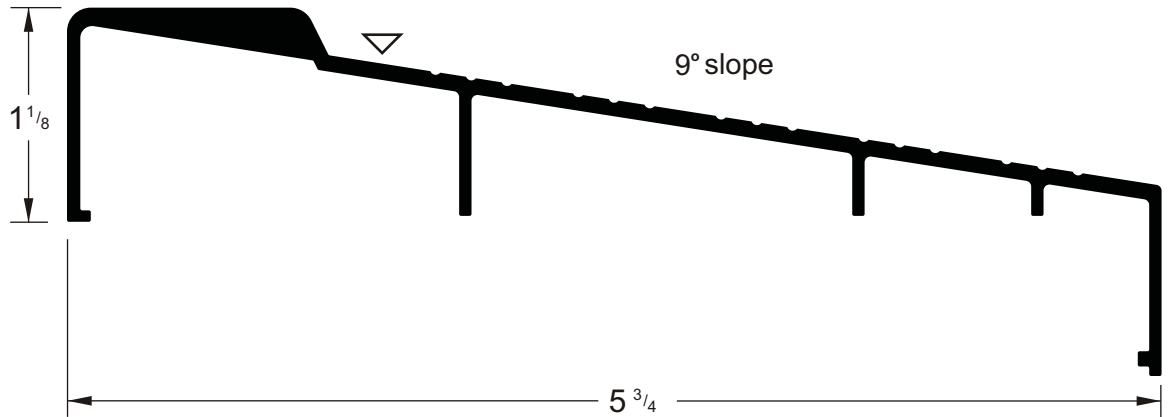

651 A, B

For jambs:
4-3/8" to 5-1/2" wide
& continuous level
floor. 10 X 2"
phillips flathead
screws are included.

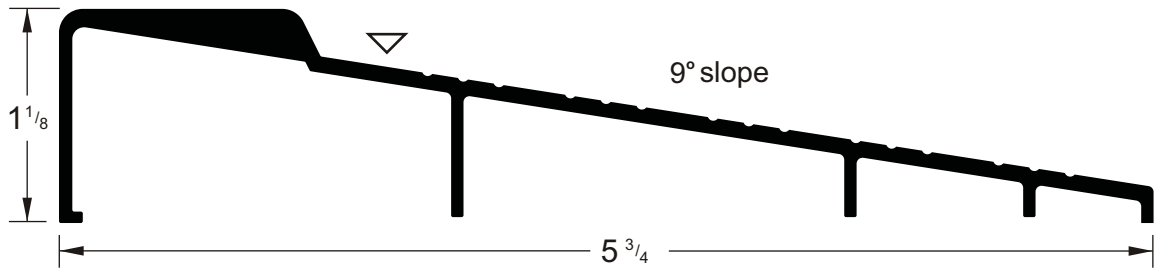

680 A, B

For jambs: 5-1/2" to 6-1/2" wide. 9° slope.
For doors 1-3/4" and over. 10 X 2-1/2" phillips
flathead screws are included.

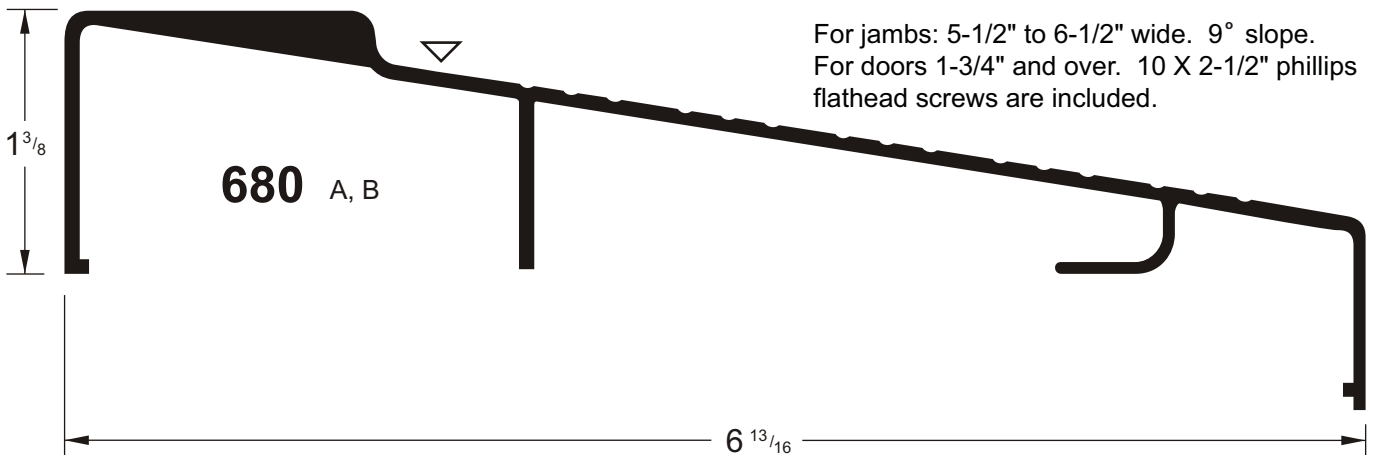

▽ Indicates location of standard fastener hole.

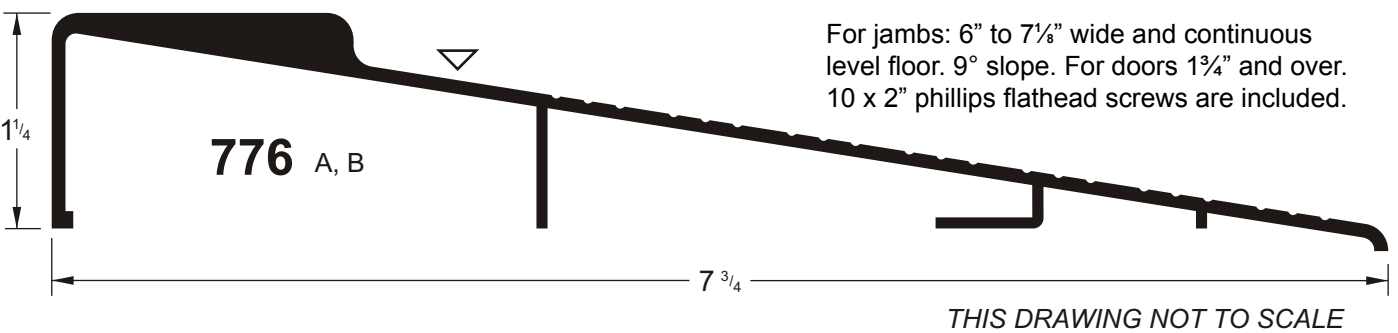
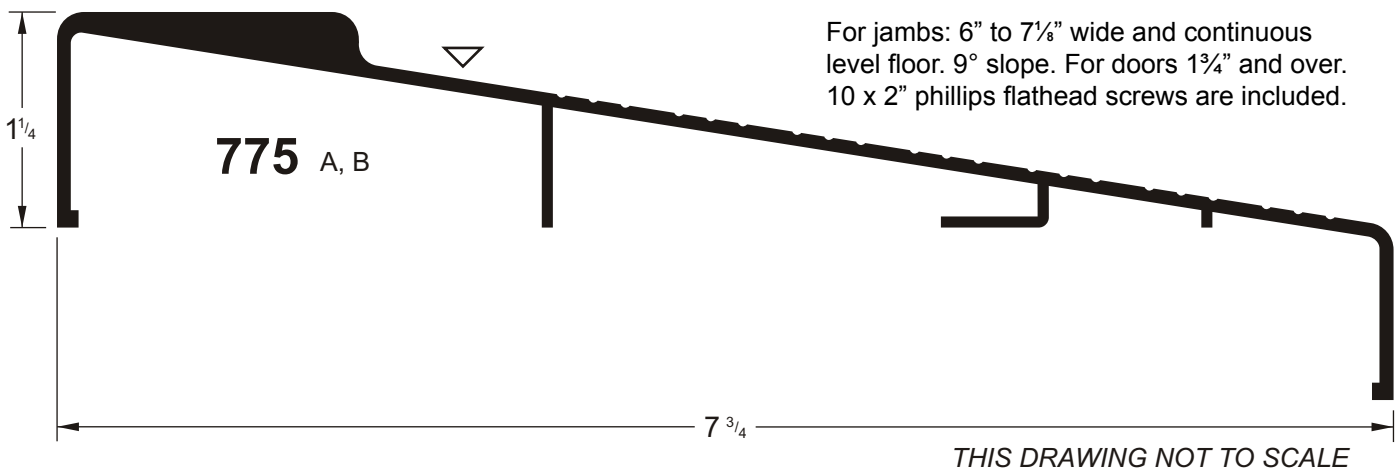
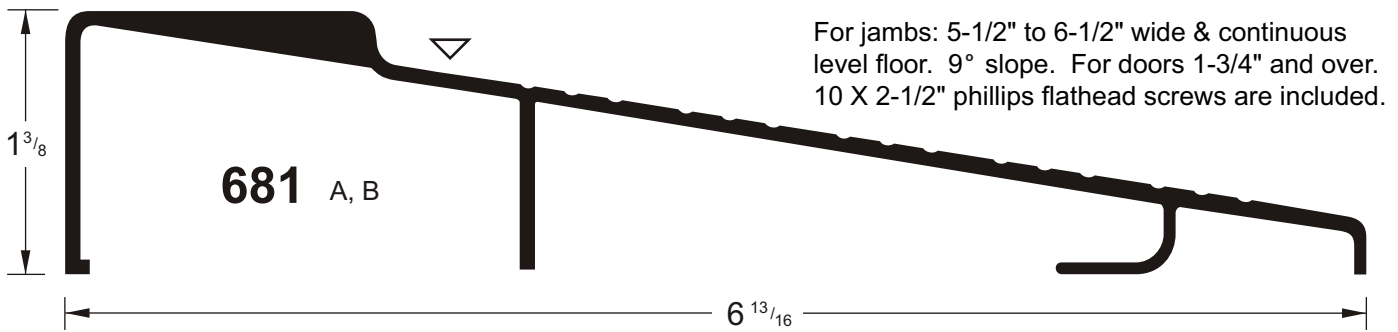

▽ Indicates location of standard fastener hole.