

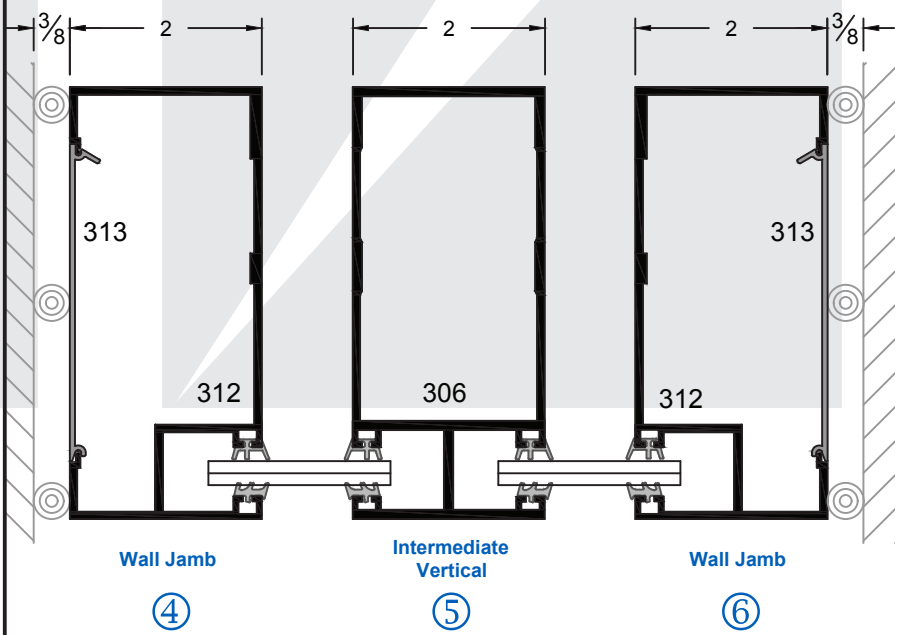

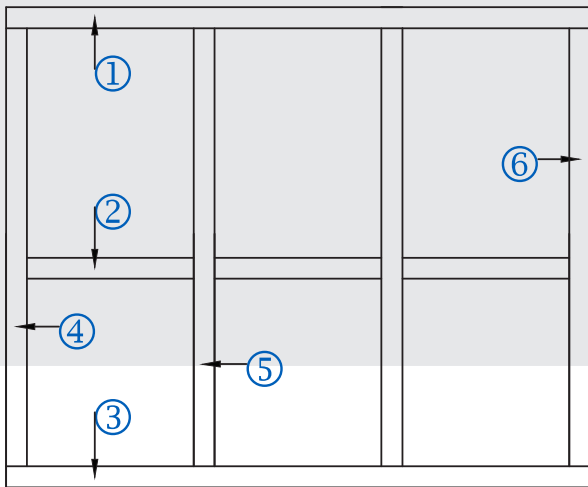

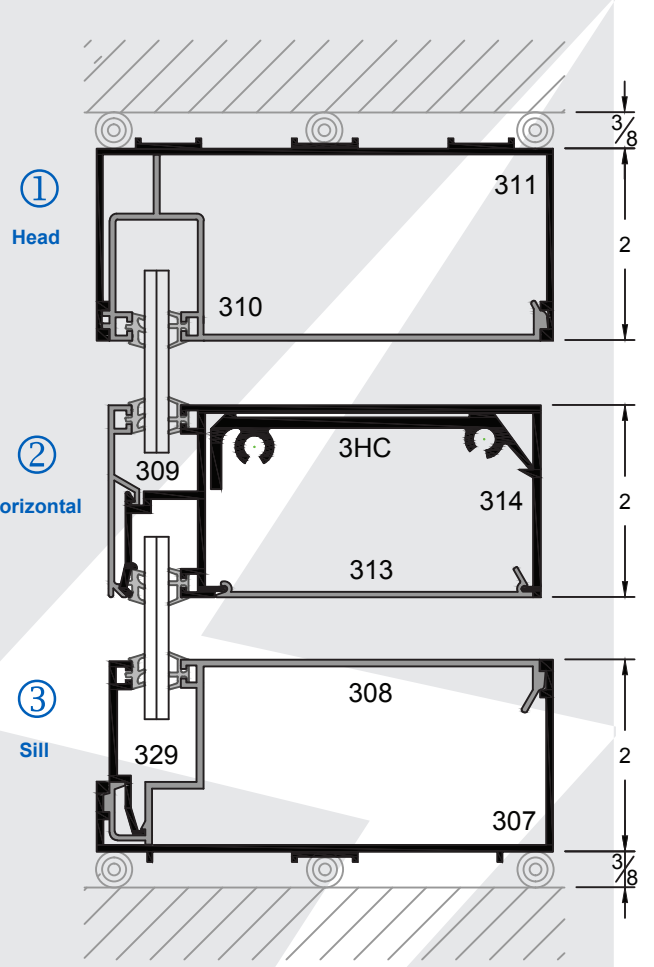

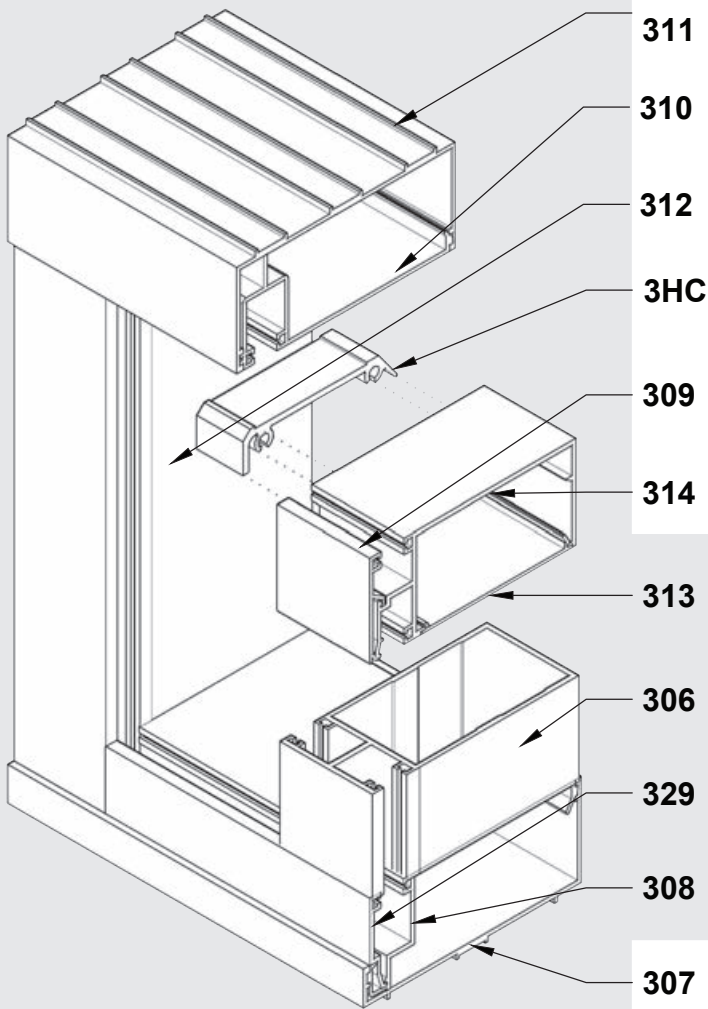











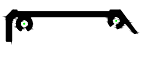

# STOREFRONT EXTRUSIONS 300 SERIES

(2" x 4 1/2" x 1/4" OFFSET GLAZED SYSTEM)



## PARTS: 300 SERIES

(2" x 4 1/2" x 1/4" OFFSET GLAZED SYSTEM)

PART NO.	DESCRIPTION	DRAWING	PART NO.	DESCRIPTION	DRAWING
CE311	Head Can		CE312	Wall Jamb	
CE310	Head Can Filler		CE304	Vertical	
CE307	Sill Can		CE306	Intermediate Vertical	
CE308	Sill Can Insert				 
CE329	Glass Stopper for Sill Can		CE3HC	Horizontal Clip	
CE314	Horizontal		CE317	90° Corner Post (Offset)	 
CE313	Horizontal Filler/ Wall Jamb Filler		CE318	90° Corner Post (Offset)	 
CE309	Glass Stopper for Horizontal		CE319	90° Corner Post (Offset)	 

FINISH: CA = CLEAR ANODIZED BA = BRONZE ANODIZED