

THE
MILLENNIUM[®]
COLLECTION

DECORATIVE
INTERIOR WOOD DOORS



Interior doors that transform.



State-of-the-art design and environmentally friendly construction techniques mean endless design flexibility for your architectural design.

The Millennium Collection consists of four distinct interior door products that each fit a specific demand in the world of design and construction. Encore, Ovation, Infinity, and Bravo doors are all manufactured of renewable composite wood fiber materials for stability and reliability. Our state-of-the-art design and environmentally friendly construction techniques mean endless flexibility for your architectural design. The Millennium Collection will provide unique solutions to any paint grade door application requirement. Take a moment to go through this catalog and you will begin to understand the value and excitement that these doors can bring to your project.

TABLE OF CONTENTS

ENCORE®

Router Carved Doors04

OVATION®

Layered Panel Doors12

INFINITY®

Inlaid Molding Doors22

BRAVO®

Traditional Stile & Rail Doors28

Modern Shapes™

Modern Shapes by Millennium®32

Specialty

Textured Glass Doors34

White Laminated Doors35

Mirror Doors35

Chalkboard & Dry Erase Doors36

Louver Doors36

Barn Doors37

Bifold Doors38

Arch Top & Radius Top Doors38

90-Minute Fire Rated Doors39

Warranty & Installation

Warranty41

Care, Finishing & Installation42



THE
MILLENNIUM®
COLLECTION

ENCORE®

Router Carved

OVATION®

Layered Panel

INFINITY®

Inlaid Molding

BRAVO®

Traditional Stile & Rail



ENCORE[®]
Router Carved Doors

ENCORE® DOORS

Each Encore door is individually carved to exacting tolerances by our CNC computer-driven equipment and is constructed of laminated MDF with our patented Integra-Lok® stiles for maximum screw-holding performance. The result is a beautiful door that offers extreme design flexibility. The unique construction process of our Encore router carved doors allows for intricate and virtually unlimited design possibilities.



- Dramatic raised panels or grooved options
- Traditional molding profiles
- Custom design flexibility
- 152 designs available
- Solid surface construction
- No possibility of stile and rail separation
- State-of-the-art production capability
- Factory primed
- Integra-Lok® stiles for screw holding performance
- Environmentally friendly recycled material may help earn LEED credits
- Made in the USA
- Limited Lifetime warranty

We offer 152 standard designs or you may create your own special design. Our engineering lab will be happy to review any custom request. Encore router carved doors, with foam core or optional solid MDF core, are available in 1-3/4" and 1-3/8" thickness.

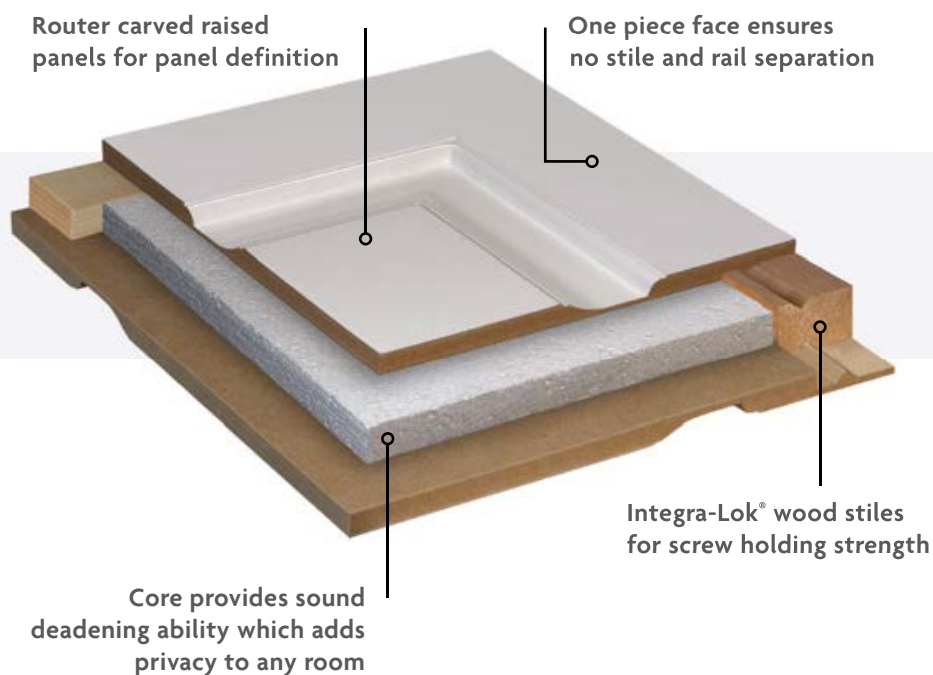

ENCORE® DOORS

Fire Rating:

Up to 90-minute positive pressure fire ratings available with solid intumescent core. For more detailed fire rating information, visit our website at millenniumdoors.com.

STC (Sound Transmission Class):

Encore door panels carry comparably high ratings per ASTM E90-90. Our standard 1-3/4" MDF solid core door was certified at STC 36 with several seal systems available. Other STC information can be seen on our website at millenniumdoors.com or by speaking to one of our sales representatives.

Encore Sticking Profiles:



Standard Sticking



Ogee Sticking

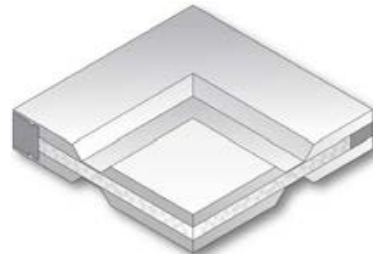

Bevel Sticking



INP Sticking



No Sticking

Specifications:

- Traditional router raised panels provides uniform structural support. Seamless stile and rail design with no possibility of separation. Will not shrink, split, or warp.
- Doors available in both 1-3/8" or 1-3/4" thicknesses.
- Doors available up to 4/0 in width and 8/0 in height.
- Moisture resistant type 1 glue internal construction.
- Foam core design creates architecturally correct door weight, consistent with standard stile and rail doors.
- Primed all six sides, ready to start the finishing process (see care & finishing instructions).
- One or both sides routed or separate designs on each side.

The Integra-Lok® wood edge
U.S. PATENT #7,210,274

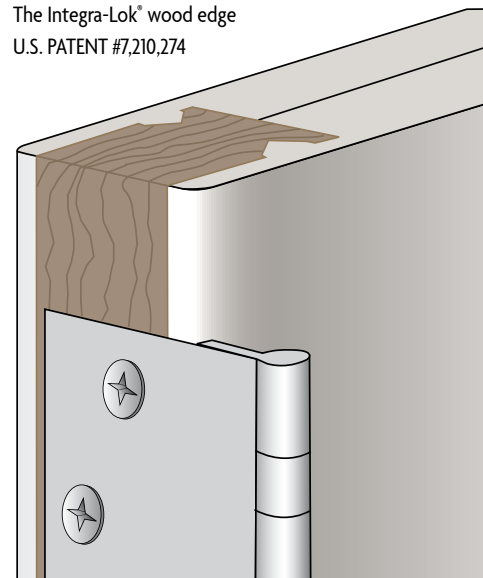







ENCORE® STANDARD DESIGNS

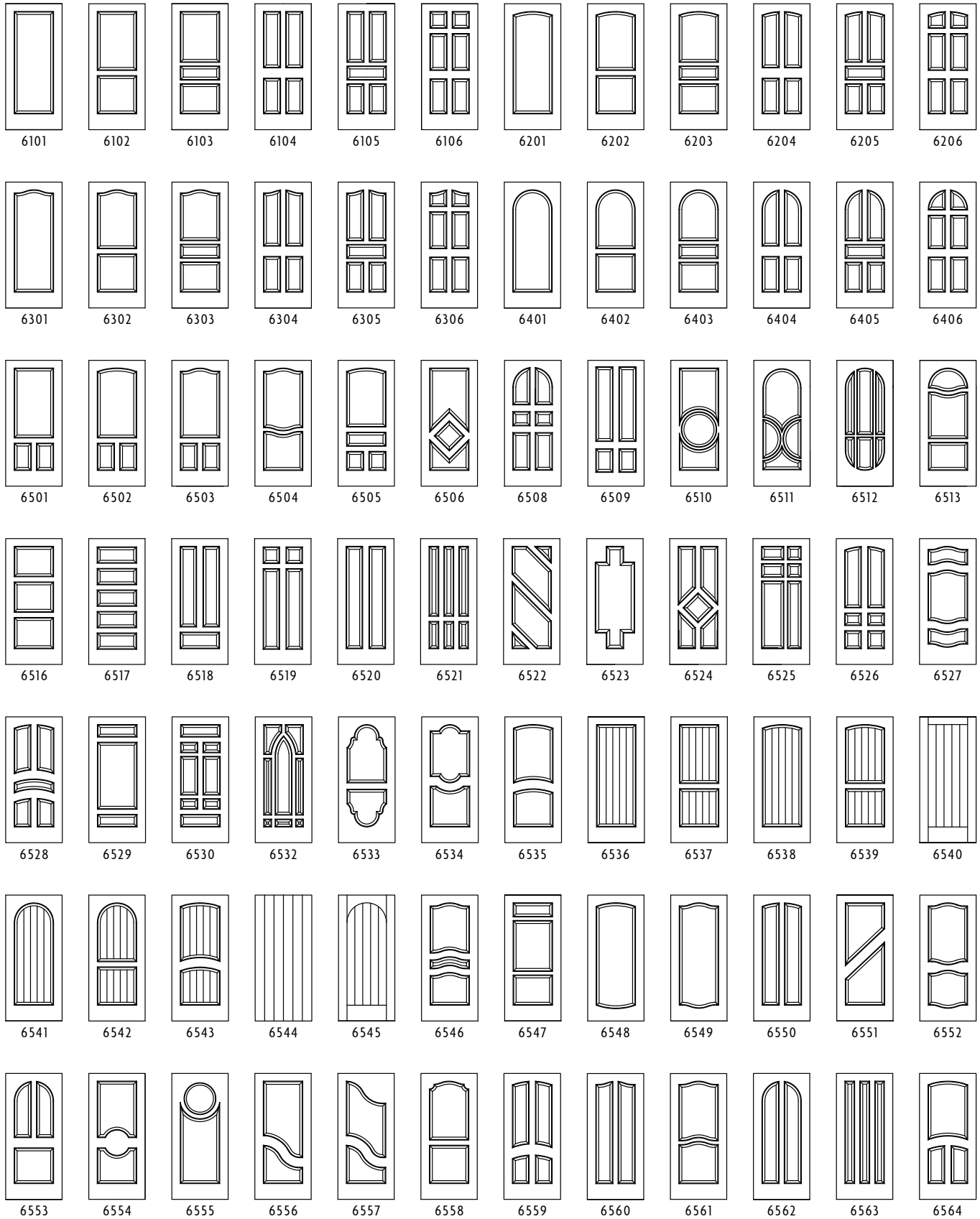

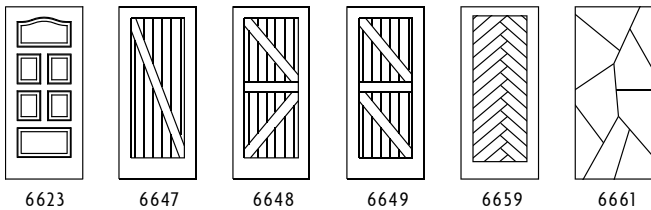
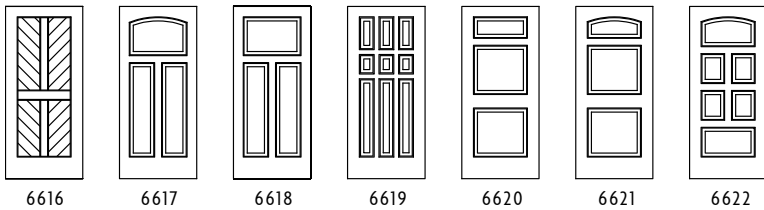
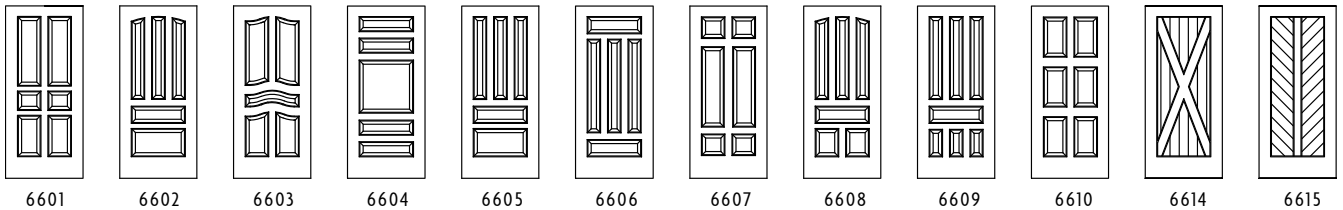
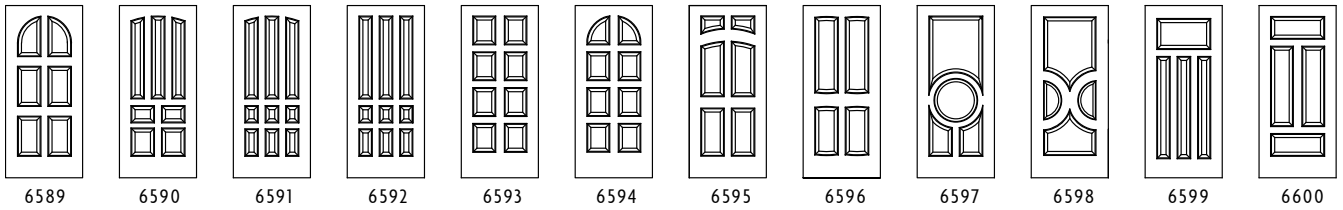
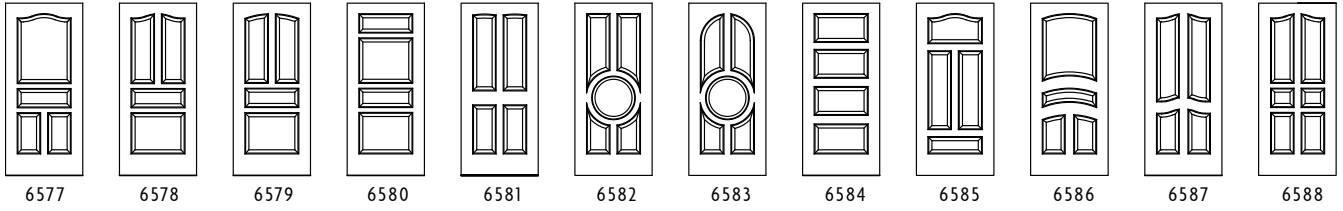
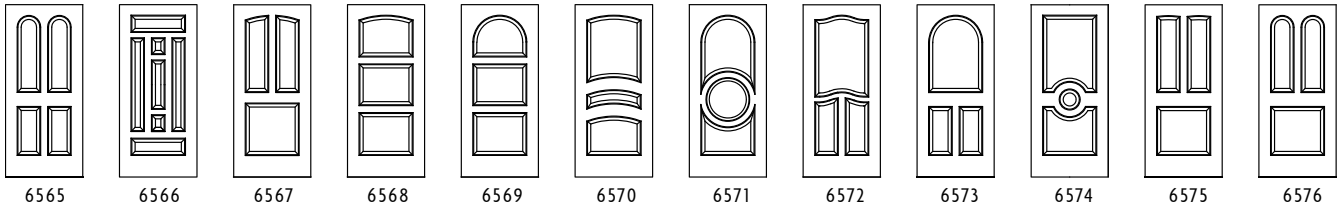

CONTEMPORARY DESIGNS

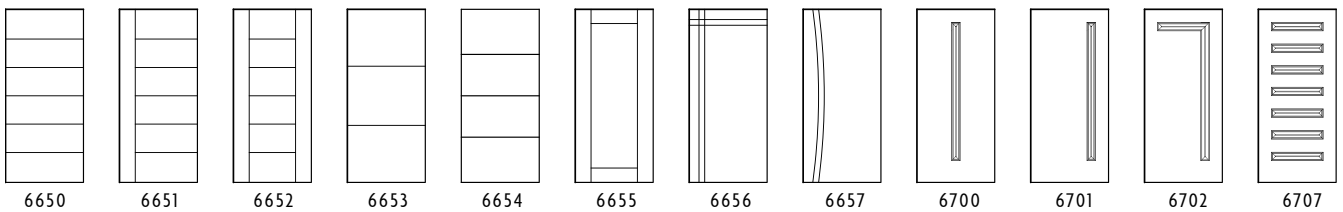



OVATION®

Layered Panel Doors

OVATION® DOORS

The revolutionary Ovation Door is precision-crafted from components made of medium density fiberboard (MDF). This stable wood-based material is an environmentally friendly substrate that will not split or warp, and provides a smooth paintable surface.



- Uniquely layered construction
- 146 standard designs, plus custom design flexibility
- Doors available in both 1-3/8" or 1-3/4" thicknesses
- Doors available up to 4'0" in width and 8'0" in height
- Integra-Lok® wood edge for screw holding strength
- Factory primed
- Environmentally friendly recycled material may help earn LEED credits
- Made in the USA
- Limited Lifetime warranty

Crafted from an environmentally friendly substrate for a smooth paintable surface

One piece face ensures no stile and rail separation

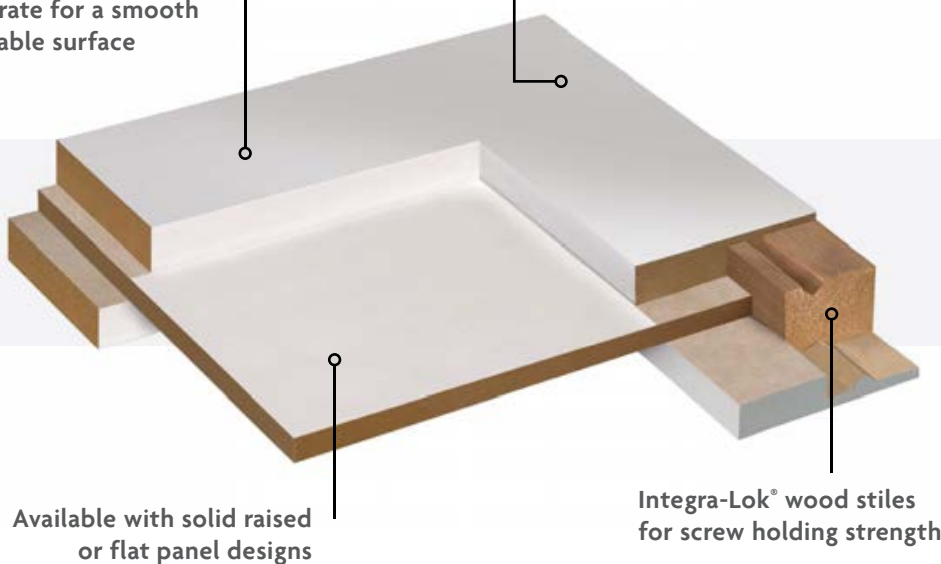

Available with solid raised or flat panel designs

Integra-Lok® wood stiles for screw holding strength

OVATION® DOORS

The Fiberfuse® process bonds the pre-machined sheets into a layered composite under extreme pressure. Exterior grade type one glue is utilized for strength and durability. Technology, engineering, and craftsmanship come together to make the Ovation Door superior to any other composite door product on the market.

Our patented Integra-Lok® wood edge is keyed and bonded into the edge of every Ovation Door utilizing our Fiberfuse® process. This unique design feature will not allow the wood edge to pull out and ensures screw holding strength.

Fire Rating:

Up to 90-minute positive pressure fire ratings available with 5/8" flat panel single doors, 7/8" flat panel pairs. Maximum size 20-minute up to 8/0 x 8/0 pairs. 45 thru 90-minute up to 7/0 x 8/0 pairs. For more detailed fire rating information, visit our website at millenniumdoors.com.

STC (Sound Transmission Class):

Ovation door with 1-1/4" raised panels carry comparably high ratings per ASTM E90-90. Our 1-3/4" door with 1-1/4" raised panel was certified at STC 34 and our 90-minute intumescent core door had a STC rating of 34 both using approved seals and approved automatic door bottom. Millennium doors were tested and certified by Intertek in Courtland, NY. Other STC information can be seen on our website at millenniumdoors.com or by speaking to one of our sales representatives.

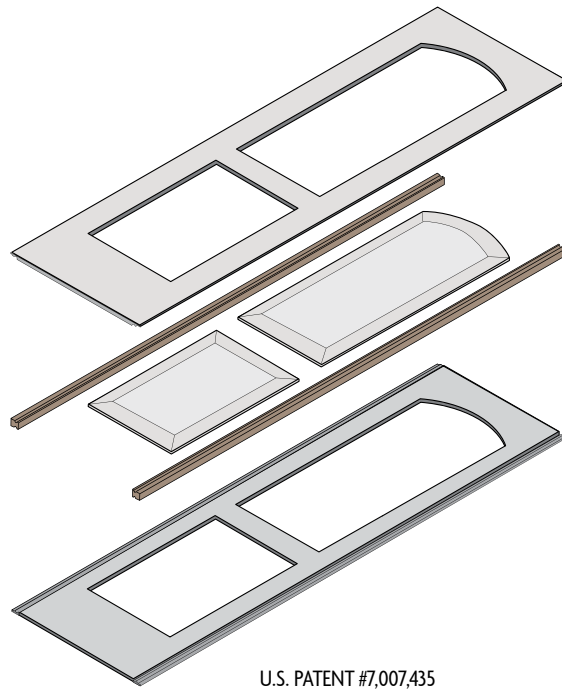

The Integra-Lok® wood edge
U.S. PATENT #7,210,274

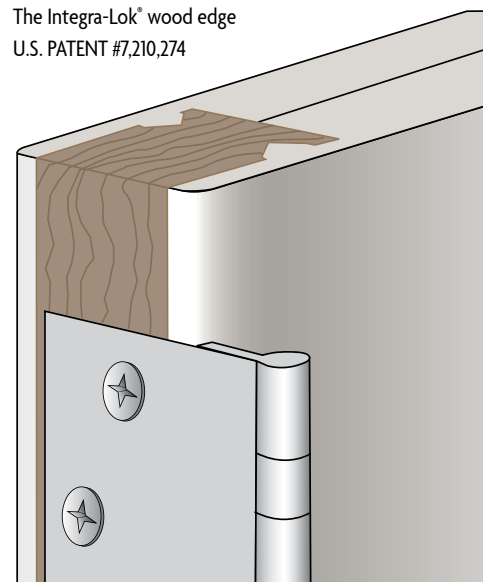



Ovation Sticking Profiles:

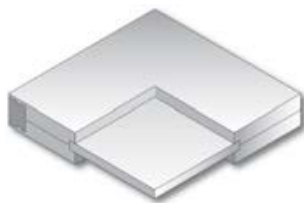

No Sticking
Shown with flat panel option



No Sticking
Shown with raised panel option*

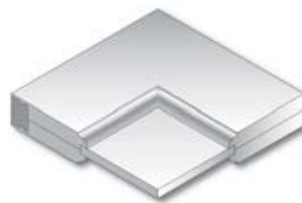

Round Sticking
Shown with flat panel option



Round Sticking
Shown with raised panel option*



Square Sticking
Shown with flat panel option



Square Sticking
Shown with v-groove scoop panel option

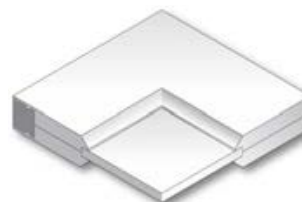

Bevel Sticking
Shown with flat panel option

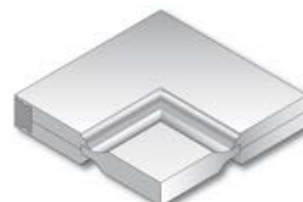

Ogee Sticking
Shown with raised panel option*



Ovation Modern Step
Shown with flat panel option

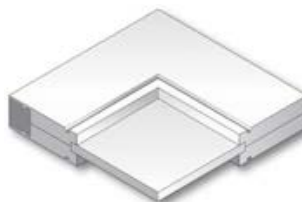

No Sticking & Quirk Dado
Shown with flat panel option

*Also available in scoop raised panel



OVATION® BOLECTION MOLDING

Customize your look even further by incorporating bolection molding into your Ovation door. Offered in two sizes, these moldings are inlaid around the edge of the door panels. While some designs are limited due to space, bolection moldings add another layer of depth – beautifully complimenting the appearance of the door and bringing special detail to your project or home.



Bolection Sticking Profiles:

(all shown with flat panel option)

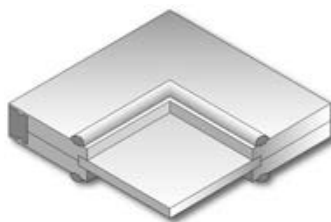

No Sticking
Small Bolection

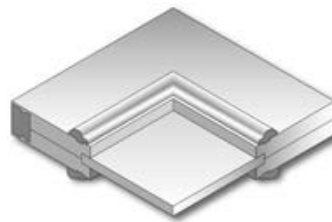

No Sticking
Large Bolection

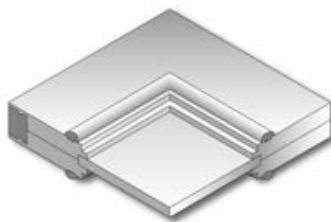

Square Sticking
Small Bolection

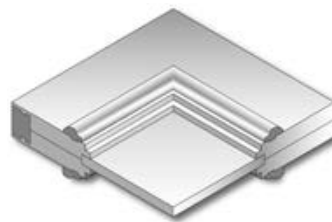

Square Sticking
Large Bolection



Round Sticking
Small Bolection

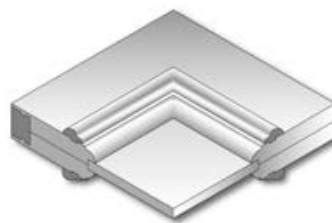

Round Sticking
Large Bolection



Ogee Sticking
Small Bolection

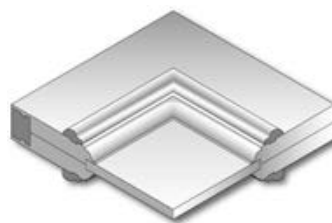

Ogee Sticking
Large Bolection



Ovation Modern Step
Large Bolection



Ovation Bevel Sticking
Small Bolection

OVATION® STANDARD DESIGNS

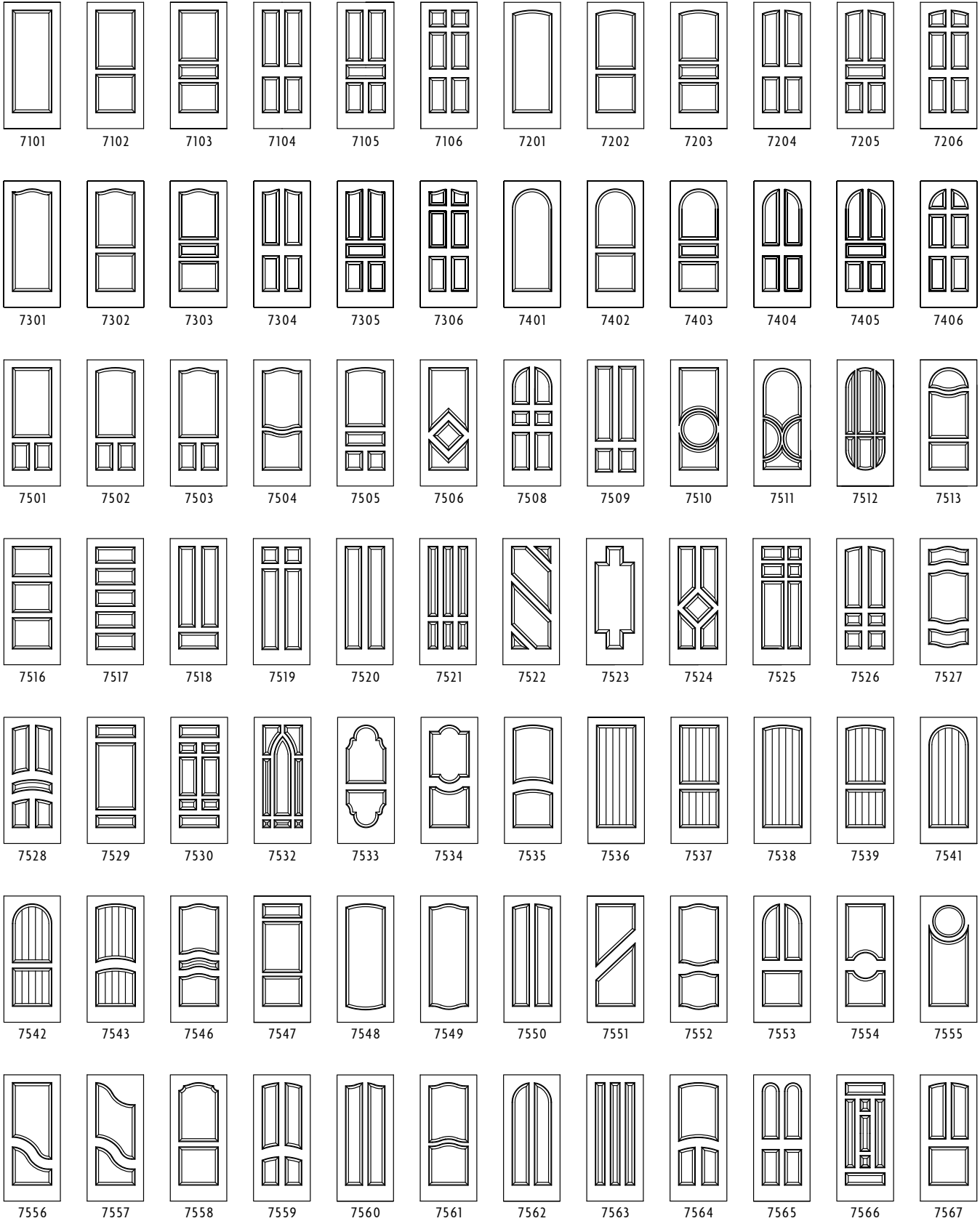

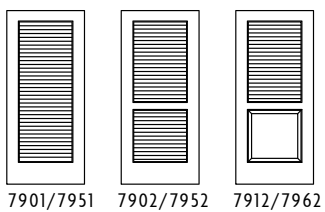
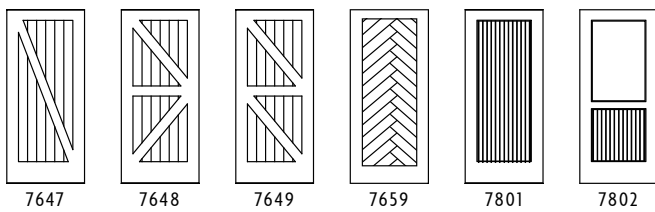
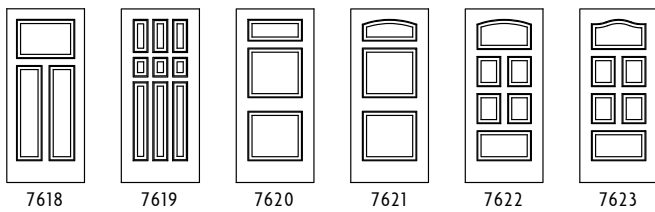
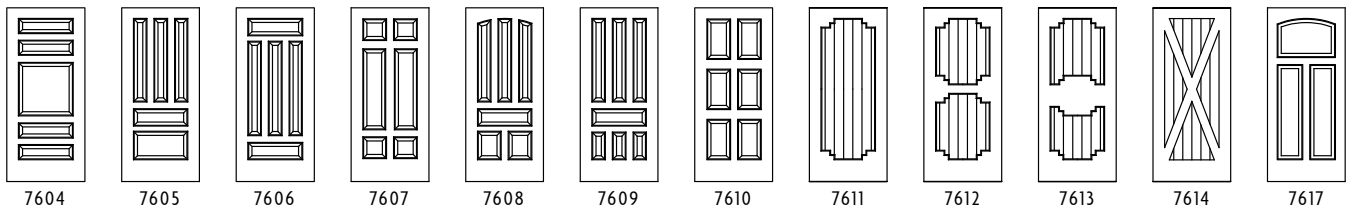
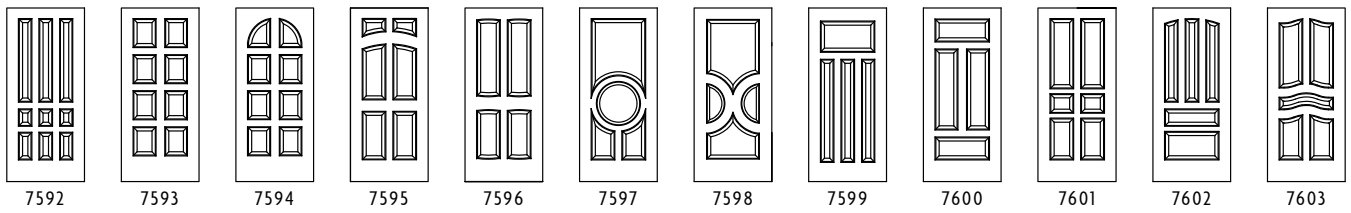
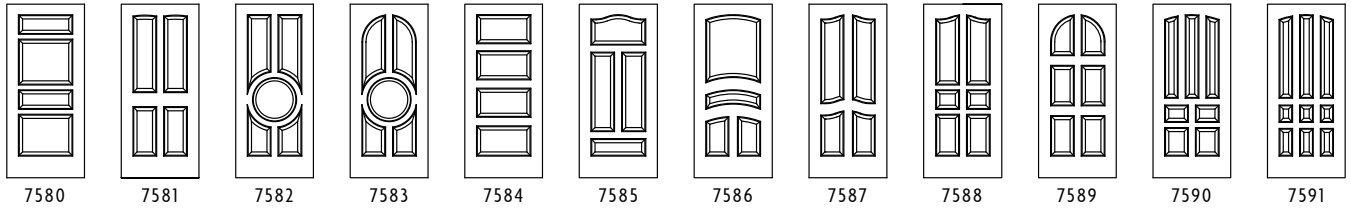
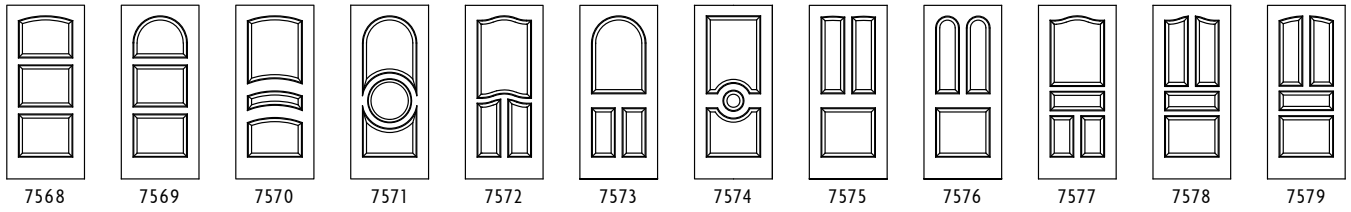







INFINITY[®]
Inlaid Molding Doors

INFINITY® DOORS

Uniquely designed composite doors with a raised panel appearance and decorative raised molding. The elegant appearance and superior value of Infinity Inlaid Molding Doors make them a perfect choice for any project. No other door can offer this combination of beauty, detail, function, and value.

- Features dramatic raised panels
- Detailed inlaid molding profiles: Raised, Flush, and Plant-on
- Patented, integral panel design
- 138 standard designs, plus custom design flexibility
- Doors available in both 1-3/8" or 1-3/4" thicknesses
- Doors available up to 4'0" in width and 10'0" in height
- Factory primed
- Environmentally friendly recycled material may help earn LEED credits
- Made in the USA
- Limited Lifetime warranty

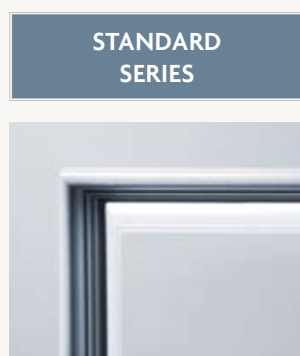

molding with raised panels create a dramatic impression



molding enhances the scale and proportion on larger doors

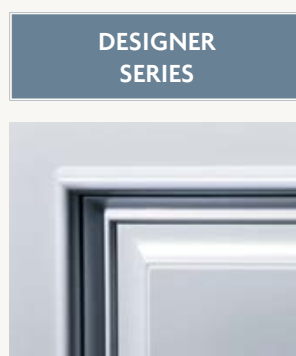

molding adds intricate detail for a striking appearance

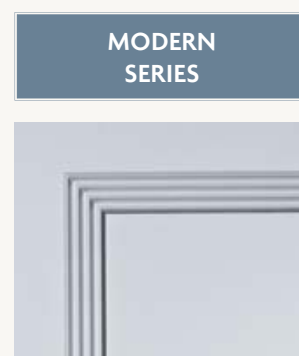

Raised V Molding
creates a dramatic contemporary design

Raised Inlaid molding for a dramatic appearance

Primed on all six sides - ready to paint



Solid continuous particle board core for noise reduction

Wood stiles for screw holding strength

INFINITY® DOORS

Our patented solid core premium construction features MDF raised inlaid molding and a dramatic raised panel. 138 standard designs are offered and custom design layouts are available in both 1-3/4" and 1-3/8" thick configurations, up to 4/0 x 10/0. Infinity Doors are offered in three different raised molding profiles with the accompanying flush molding for bypass or pocket applications.

The Infinity Series molding and panel profiles offer a wide range of design layouts, from traditional to contemporary. The Architectural and Designer Series have been developed to specifically enhance the character of larger 1-3/4" doors. While the Architectural molding profile increases the visual depth, the Designer series offers high-profile dimensionality. If dramatic contemporary lines are what your project needs, the Modern Shapes Raised V molding profiles offer clean compounded lines.

Fire Rating:

Up to 90-minute positive pressure fire ratings available with solid intumescent core. For more detailed fire rating information, visit our website at millenniumdoors.com.

STC (Sound Transmission Class):

Encore door panels carry comparably high ratings per ASTM E90-90. Our standard 1-3/4" MDF solid core door was certified at STC 36 with several seal systems available. Other STC information can be seen on our website at millenniumdoors.com or by speaking to one of our sales representatives.



Specifications:

- Patented precision design with integral panels provide uniform structural support. With a seamless stile and rail, there is no possibility of separation, shrinking, splitting, or warping.
- Doors available in both 1-3/4" and 1-3/8" thicknesses and feature a smooth MDF surface.
- Internal stiles crafted from solid wood.
- Solid continuous particleboard core.
- Primed all six sides ready to begin the finishing process (see care and finishing instructions).
- Customized designs are available. Our engineering lab will review all design requests.
- Environmentally friendly recycled material may help earn LEED credits.



Infinity Profiles:

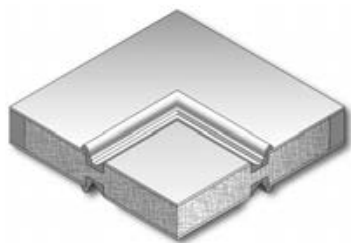

Standard Raised

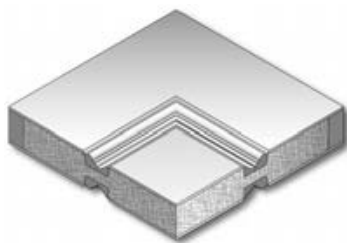

Standard Flush

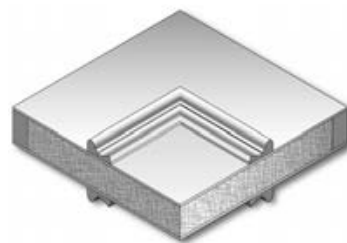

Standard Plant-on

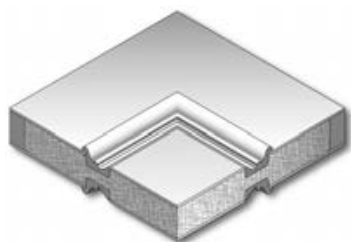

Architectural Raised

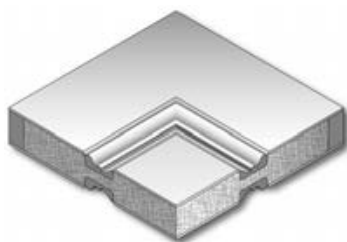

Architectural Flush

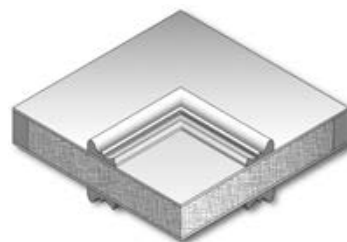

Architectural Plant-on

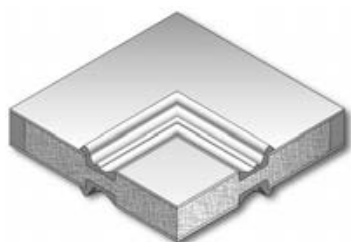

Designer Raised

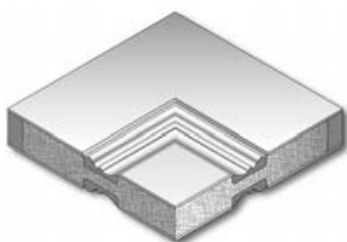

Designer Flush

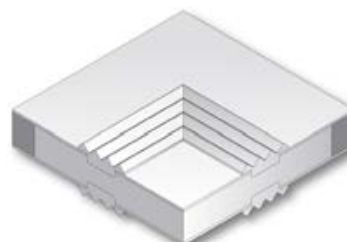

Modern Shapes
Raised V Molding

INFINITY® STANDARD DESIGNS

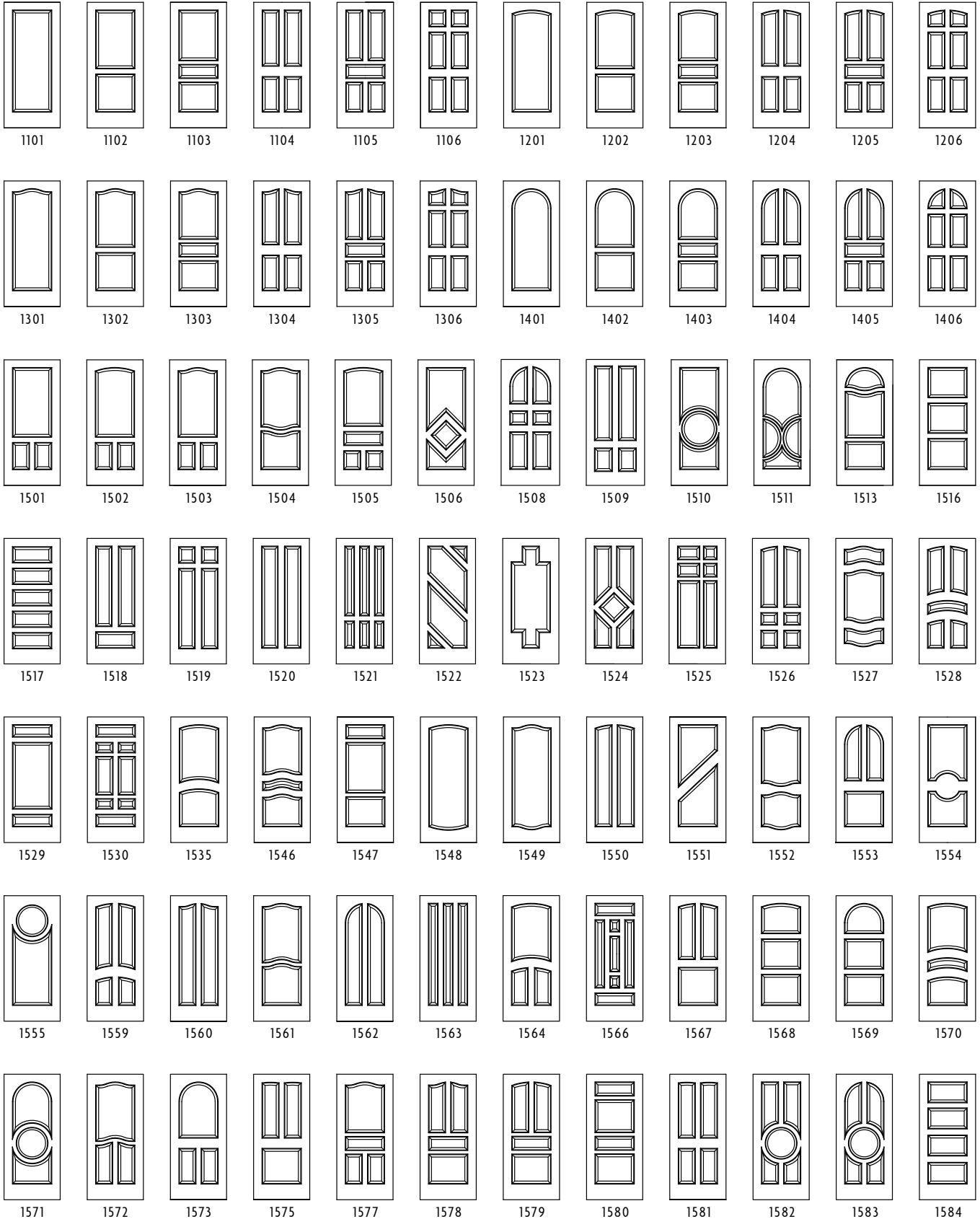



1585

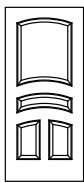

1586

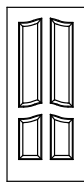

1587

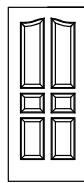

1588

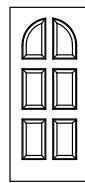

1589

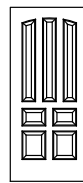

1590

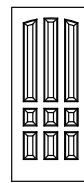

1591

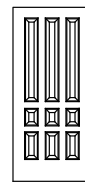

1592

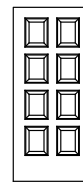

1593

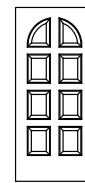

1594

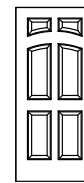

1595



1596

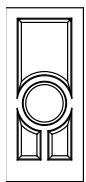

1597



1598

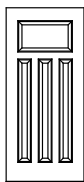

1599

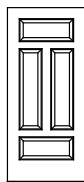

1600

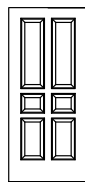

1601

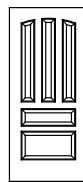

1602

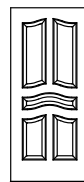

1603

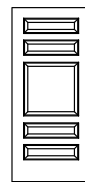

1604



1605

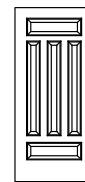

1606

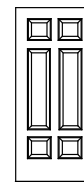

1607



1608

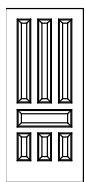

1609

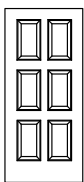

1610

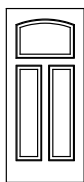

1617

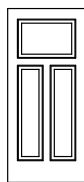

1618

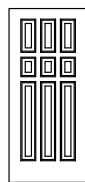

1619

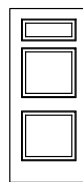

1620

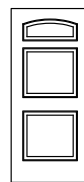

1621

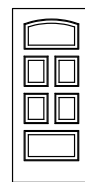

1622

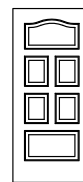

1623

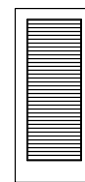

1901/1951

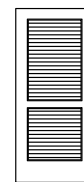

1902/1952

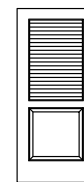

1912/1962

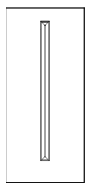

1700

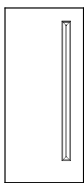

1701



1702

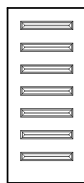

1707

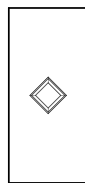

1721

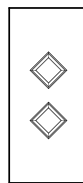

1722

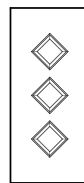

1723

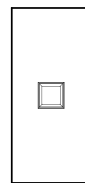

1731

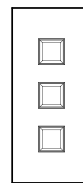

1733

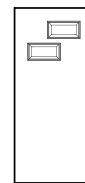

1742

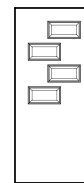

1744

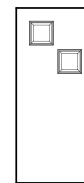

1752

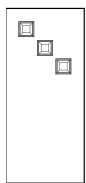

1753

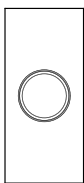

1760

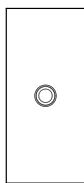

1761

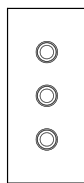

1763





BRAVO®

Traditional Stile & Rail Doors

BRAVO® DOORS

Sometimes you need to refer to history to achieve traditional millwork details. Millennium Bravo doors are built exactly like wood doors made centuries ago. Featuring traditional doweled stile and rail construction, following classic millwork details and joinery. Separate solid wood stiles, rails, and panels are assembled by hand with twenty-first century technology. Utilizing modern materials and state-of-the-art equipment, Bravo delivers the best of both worlds.

- 47 traditional stile and rail designs
- Crisp detailed miters and profiles
- Doweled and bonded construction
- Architecturally correct panel configuration
- Custom design capability
- Doors available in both 1-3/8" or 1-3/4" thicknesses
- Doors available up to 4/0 in width and 9/0 in height
- Made from stable MDF
- Solid wood stiles
- Warp and bow resistant
- Factory primed
- 20-minute fire ratings
- Environmentally friendly recycled material may help earn LEED credits
- Made in the USA

Fire Rating:

20-minute positive pressure fire ratings available. Maximum size up to 3/0 x 8/0 single. For more detailed fire rating information, visit our website at millenniumdoors.com.

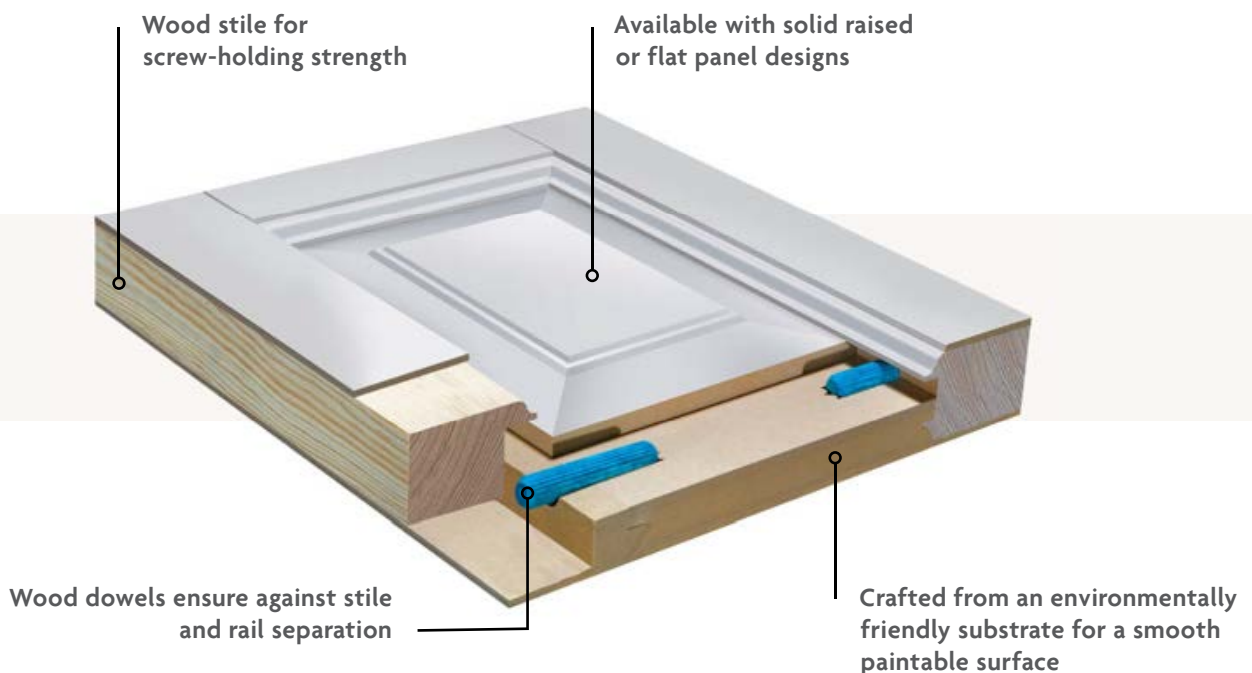



BRAVO® DOORS

If you have a historic renovation project or are just looking for the most traditional wood door detail you can find, Bravo is the answer. Built with a state-of-the-art computer-controlled manufacturing process, utilizing environmentally responsible materials and proudly made in the United States.

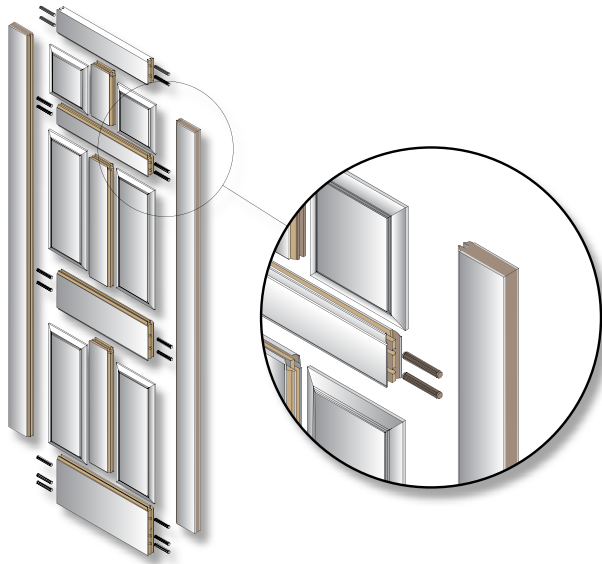

Bravo Sticking* Profiles:



Ogee Sticking
Shown with raised panel option



Ovolo Sticking
Shown with raised panel option



Square Sticking
Shown with flat panel option



Bevel
Shown with flat panel option



No Sticking
Shown with flat panel option

BRAVO® STANDARD DESIGNS

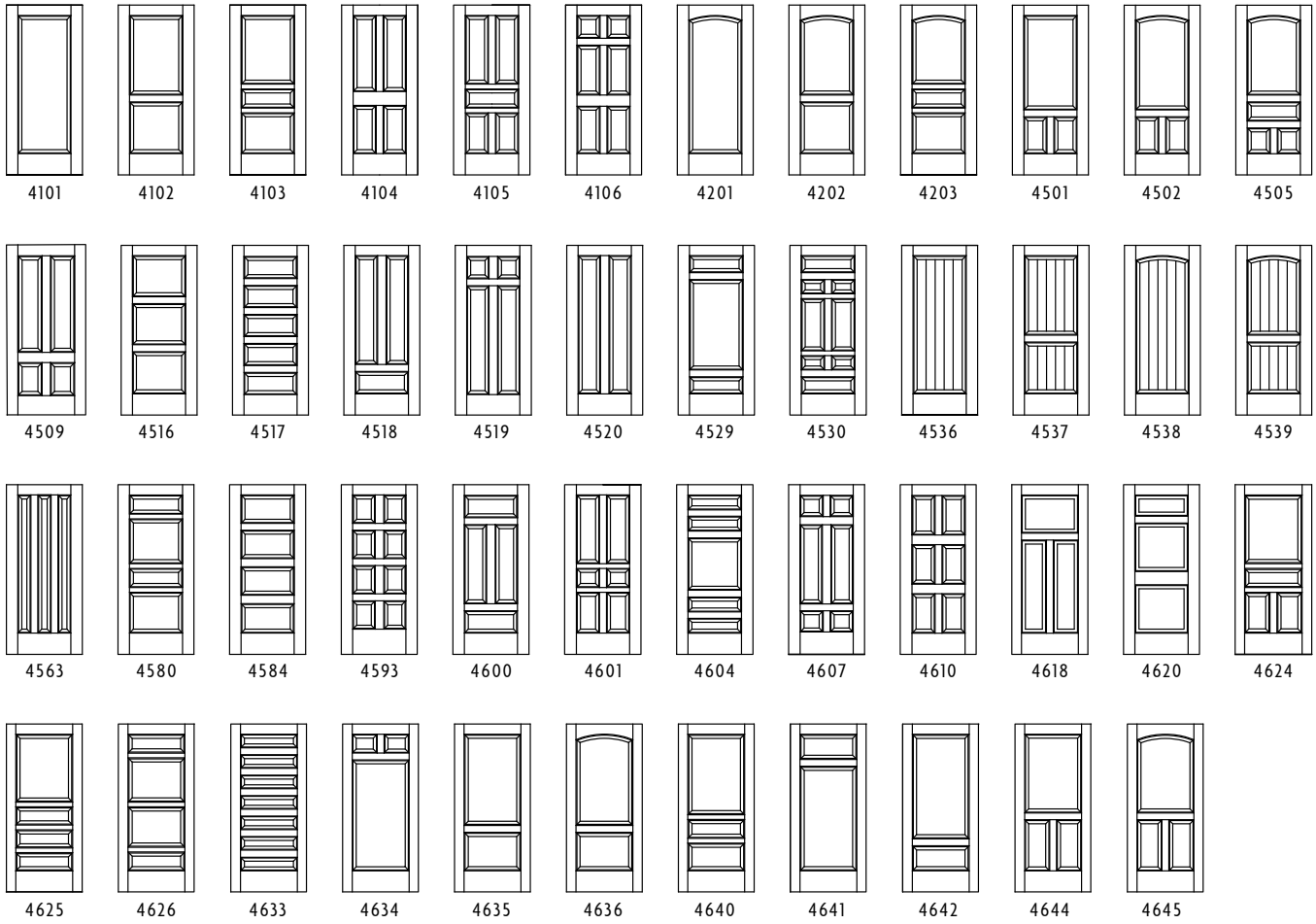

MODERN SHAPES™

With many different profile and sticking options, the Modern Shapes collection is available within each of the Millennium door lines and offers a distinctive contemporary look. With a focus on clean lines, these doors are a great fit for both modern and mid-century revival architecture.

- Modern designs enhance any contemporary project
- State-of-the-art construction
- Solid surface construction with no possibility of stile and rail separation
- Factory primed
- Integra-Lok® stiles for screw holding performance
- Environmentally friendly design made from recycled content
- Made in the USA



Encore West Groove



Encore V-Groove



Encore Square Groove



Shown with Encore Bevel Sticking





**Infinity Raised
V Inlaid Molding**

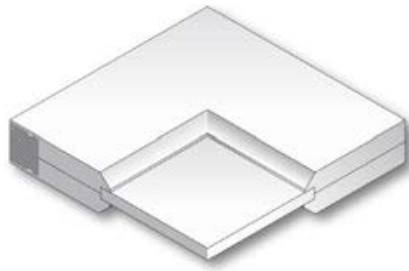

**Bevel Sticking
with Sharp Edges**

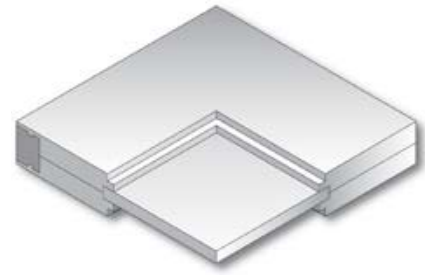

Square Sticking



**Ovation Modern
Step Sticking**

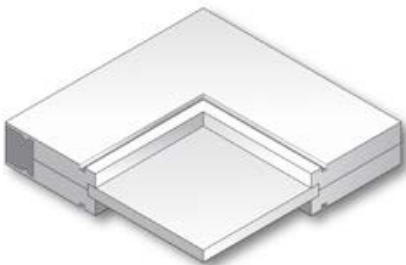

**Ovation with Quirk Dado
with No Sticking**

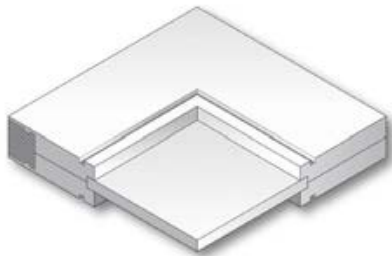

**Quirk Dado Profile
with No Sticking**
(can be used in Encore or Ovation)



TEXTURED GLASS DOORS

One-piece tempered glass available in Obscure, Rain, or Reed pattern adds a high level of privacy and modern appeal, making them the perfect choice for any interior application. Clear tempered, P516 obscure, reed, and rain glass available to replace any square panel in Infinity raised molding or Ovation with your choice of sticking.



P516
Obscure
Glass



Rain Glass

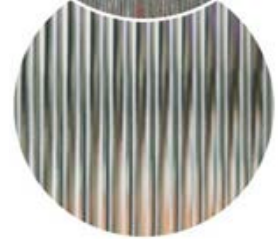

Reed Glass



SPECIALTY DOORS

WHITE LAMINATED GLASS DOORS

- White laminated glass is constructed with a PVB plastic interlayer between two sheets of glass to form one single, opaque, impact-resistant sheet.
- Laminated glass has a sound control rating of STC 34, effectively blocking out unwanted noise.
- Screens out harmful ultraviolet light.
- Reduced risk of shattering or penetration – glass particles cling to vinyl interlayer increasing security and peace of mind.
- Smooth both sides for easy clean up.
- Doors come factory primed.



MIRROR DOORS

Mirror options are available in the Infinity, Ovation, and Encore collections, making them ideal for bathrooms, closets, and dressing rooms.

Infinity doors feature mirrors on both sides, enhanced by elegant raised molding, while Encore and Ovation doors offer versatile options, including mirrors on both sides or a split design with a mirror on one side. In the split configuration, Encore doors can combine intricate router-carved detailing on one side with a variety of finishes on the other, while Ovation doors feature flat-panel construction for a sleek, modern aesthetic. Additionally, mirrors can be customized with a soft arch or eyebrow detail at the top, paired with your choice of sticking style for a truly personalized touch.

CHALKBOARD & DRY ERASE DOORS

With the split door option, magnetic chalkboard or dry erase can be paired with an alternate Ovation or Encore design on the opposite side. These innovative doors are great for kids' rooms, pantries, closets, workshops, or family message centers.

Ovation construction allows even more design options by allowing arch or eyebrow panel design on the chalkboard/dry erase side. When coupled with sticking options, such as round, square, or no sticking, you have design flexibility in a stile, rail, and panel type application.

For a traditional router-carved application, chalkboard/dry erase are available in the Encore line. Available in solid core, Encore offers a lighter weight alternative with even more raised panel standard designs available for split design construction.



LOUVER DOORS

Louver doors are available in Infinity with raised moldings and Ovation with a flush louver panel, perfect for bypass, pocket doors and to coordinate with craftsman designs. With their 2" reveal and cassette construction, which can be used in place of any square panel, louver doors can add a "tropical" design element to your project. Optional "true" or "false" louvers allow for air movement or privacy as required per plan.



Open True Louver
(Infinity shown)



False Louver
(Ovation shown)



BARN DOORS

Popular barn style and other sliding door applications often require oversize door panel sizes. Millennium Door produces sliding style door panels in hundreds of designs. Available up to 8/0 height and up to 4/0 in width. With barn door designs and contemporary styles, Millennium can provide all the options needed for this type of door. Specify doors with an optional wood top rail for top hanging door applications.

ENCORE

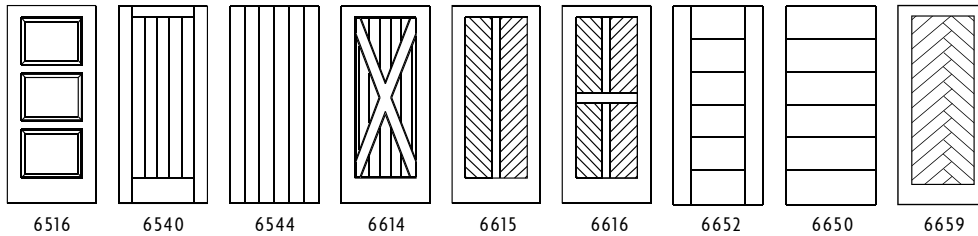

OVATION

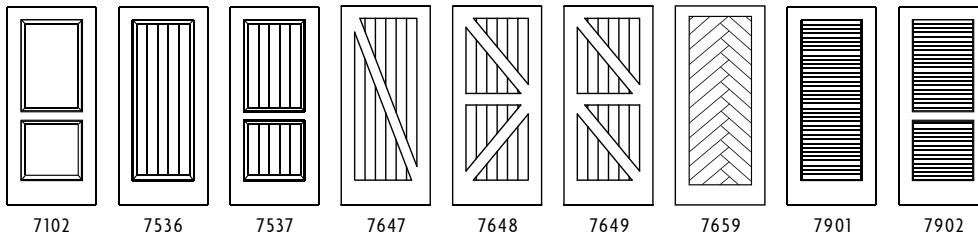

BIFOLD DOORS

- Bifold doors are ideal for use in smaller places such as closets, storage areas, and laundry rooms.
- Infinity raised molding bifold doors have raised molding on the outside and flush molding on the inside for clearance.
- Bifold doors come boxed with hardware and top guide track.
- Wood top rail and heavy-duty hardware are standard.
- 3-1/2" x 3-1/2"-5/8" radius US15 hinges are used on all Millennium bifold doors.



ARCH TOP & RADIUS TOP

Available in Encore, Ovation, and Infinity Doors, arch top and radius top doors* can be manufactured in single or matched-paired applications. Ask for detailed shop drawings for your unique opening.

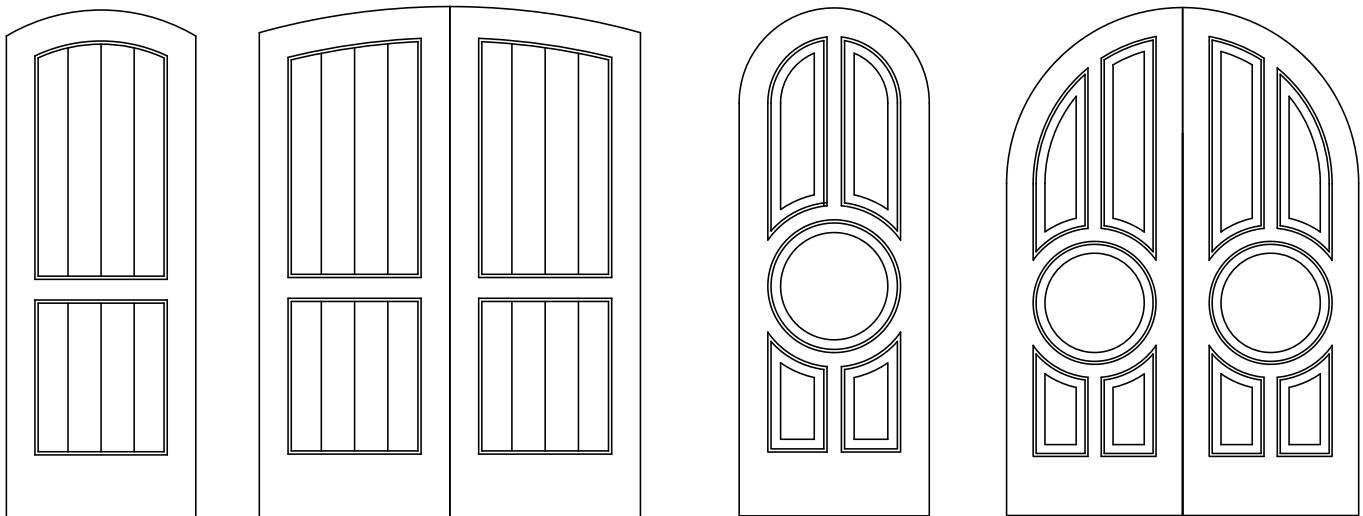

90-MINUTE FIRE RATED DOORS

Utilizing intumescent technology and our fiberfuse process, the Millennium Collection offers over 180 standard designs with unlimited customization on 90-minute doors. The 90-minute rated fire door is available in Infinity, Encore, or Ovation.

These doors are available in sizes up to 4/0 x 8/0 1-3/4 for a single and up to 7/0 x 8/0 1-3/4 as a pair. All Millennium Collection doors have fully customizable stile and rail sizes and layouts and are all paint grade, constructed with premium medium density fiberboard (MDF). The 90-minute core of these doors is constructed with layered intumescent material and is covered with MDF. The intumescent doors are rated for category A positive pressure.

This fusion of functionality and design flexibility gives the designer more control than ever before to match the theme of a building while conforming to strict fire code. To see the specifications for the 90-minute door or learn more about many of the other products offered by the Millennium Collection please visit millenniumdoors.com or call (888) 454-2888.



INFINITY

90 MIN. 1-3/4 INFINITY WITH 1-3/8" STANDARD RAISED MOLDING



90 MIN. 1-3/4 INFINITY WITH 1-3/8" STANDARD FLUSH MOLDING



ENCORE

90 MIN. 1-3/4 ENCORE WITH 1-3/8" STANDARD PROFILE



90 MIN. 1-3/4 ENCORE WITH 1-3/8" OGEE PROFILE



OVATION

90 MIN. 1-3/4 OVATION FLAT PANEL NO STICKING



90 MIN. 1-3/4 OVATION FLAT PANEL SQUARE STICKING



90 MIN. 1-3/4 OVATION FLAT PANEL 1/4 ROUND STICKING



90 MIN. 1-3/4 OVATION FLAT PANEL OGEE STICKING



NATURAL, SUSTAINABLE, RESPONSIBLE.

One pillar of a sustainable strategy is the selection of proper building materials. Sustainable materials such as MDF (medium density fiberboard) are a good environmental choice. The base material of the Millennium Door collections is MDF, made from the byproducts of the lumber industry. Because all of our doors are made in the USA, many projects we supply can help earn Regional Manufacturing credits.

We applaud projects designed for sustainability and welcome a chance to contribute. Please send your project specifics and available credits to Millennium Collection group at millenniumdoors.com or call (888) 454-2888.

LEED Credit	LEED Criteria	Product Lines - With Special Ordered Materials						
		<i>*Minimum quantities and special lead times will apply</i>						
MATERIALS & RESOURCES		Encore PBC Core	Encore Foam Core	Infinity PBC Core	Infinity Mineral Core	Ovation	Intumescent Core	Bravo
MR 4	Recycled Content: 10% Pre-Consumer - 1 point	YES	YES	YES	NO	YES	NO	YES
	Recycled Content: 20% Pre-Consumer - 2 points	YES	YES	YES	NO	YES	NO	YES
MR 5	Regional materials: 10% if within 500 miles - 1 point	YES*	YES*	YES*	YES*	YES*	YES*	YES*
	Regional materials: 20% if within 500 miles - 2 points	YES*	YES*	YES*	YES*	YES*	YES*	YES*
MR 6.0	Rapidly Renewable Materials:	NO	NO	YES	NO	NO	NO	NO
MR 7.0	Certified Wood:	YES	YES	YES	NO	YES	YES	YES
<i>*Location of project determines eligibility. Extracted and Manufactured, Harvested or Recovered within 500 mile radius of project site.</i>								
INDOOR ENVIRONMENTAL QUALITY								
IEQ 4.1	Low Emitting Materials: Adhesives & Sealants	YES**	YES**	YES**	YES**	YES**	YES**	YES**
IEQ 4.2	Low Emitting Materials: Paints & Coatings	YES**	YES**	YES**	YES**	YES**	YES**	YES**
IEQ 4.4	No Added Urea Formaldehyde	YES	YES	YES	YES	YES	YES	YES
INNOVATION IN DESIGN								
ID 2	LEED AP	YES	YES	YES	YES	YES	YES	YES
<i>**IEQ 4.1 & 4.2 applies to adhesives, sealants, paints and coatings applied at project site.</i>								

The LEED (Leadership in Energy and Environmental Design) Green Building Rating System was originally developed by the U.S. Green Building Council (USGBC) to provide a recognized standard for the construction industry to assess the environmental sustainability of building designs.

Doormerica is committed to engineering our manufacturing processes so that we may assist our customers in achieving their LEED certification rating. The chart above lists all of our product lines and what LEED credits can be earned. Doormerica is focused on being a good global partner in environmental stewardship. All Doormerica products are certified by a nationally recognized third party certification service.

Please contact us or visit millenniumdoors.com for further information

WARRANTY

WARRANTY PERIOD:

TYPE	INTERIOR	EXTERIOR	SPECIALTY PRODUCTS
INFINITY	LIMITED LIFETIME	N/A	VARIES WITH PRODUCT
OVATION	LIMITED LIFETIME	N/A	VARIES WITH PRODUCT
ENCORE	LIMITED LIFETIME	N/A	VARIES WITH PRODUCT
BRAVO	LIMITED LIFETIME	N/A	VARIES WITH PRODUCT

SPECIALTY PRODUCTS:

SPECIALTY GLASS	10 YEARS DOOR	N/A	1 YEAR SPECIALTY GLASS
MIRROR	10 YEARS DOOR	N/A	1 YEAR MIRROR
LOUVER	10 YEARS DOOR	N/A	N/A
CHALKBOARD	10 YEARS DOOR	N/A	1 YEAR CHALKBOARD
DRY ERASE	10 YEARS DOOR	N/A	1 YEAR DRY ERASE
BIFOLD DOORS	10 YEARS DOOR	N/A	1 YEAR
ARCHED/RADIUS	10 YEARS DOOR	N/A	

Limited Lifetime Warranty:

Warranty applies to the original private residential home-owner in single-family home applications and is non-transferable.

Warranty Disclaimer:

Should any door manufactured by American Building Supply fail to conform to this published warranty, American Building Supply will repair or replace the door. If repair or replacement is not practical, American Building Supply will refund the full purchase price of the door. The warranty does not cover refinishing, rehangings or any other cost related to the repair, replacement, or refund. The manufacturer will not be liable for any door(s) repaired or replaced without its prior written consent. The purchaser, upon receipt of the doors, should inspect each door. The purchaser must give written notice of any claim to American Building Supply within 15 days after receipt of doors. American Building Supply must be given a reasonable opportunity to investigate the reported defect before corrective action has begun.

This warranty is subject to the following tolerances:

1. Size tolerance: thickness ffl 1/16"; length ffl 1/16"; width ffl 1/16"; prefit width ffl 1/16".
2. Squareness tolerance diagonal measurement difference will not exceed 1/8".
3. Factory hardware preparation tolerance ffl 1/32" on hinge preparation and lock preparation cutouts.
4. Warp will not be considered a defect unless it exceeds 1/4" in the plane of the door itself. For doors 1-3/4" or thicker, warp will not exceed 1/4" in doors 3/6 x 7/0 or smaller, nor will it exceed 1/4" in any 3/6 x 7/0 section of larger doors. For doors less than 1-3/4" thick, warp will not exceed 1/4" in doors 3/0 x 7/0 or smaller. Warp is measured by placing a straight edge on the concave face and determining the maximum distance from straight edge to door face.
5. Louver door blade warp tolerance is not to exceed 1/4" between blades.

This warranty is subject to the following storage and handling instructions:

1. Doors shall always be stored flat and in clean, dry surroundings protected from dirt, water, and abuse. If stored for a long period of time, the doors must be sealed on all six sides with a high quality primer sealer. Never store doors directly on concrete and allow spacing for proper ventilation.
2. Doors must not be exposed to excessive amounts of moisture, heat or direct sunlight.
3. Doors must always be handled with clean hands or clean gloves.
4. Doors must always be lifted and carried, do not slide or drag across one another.

This warranty is subject to the following finishing instructions:

1. Interior primed doors should be finished in accordance with our published Care & Finishing Instructions in this warranty.

Warranty limitations and exclusions:

1. Doors used in exterior application.
2. Doors painted dark colors without protection from the elements.
3. The natural variations or unsatisfactory results in color, texture, gloss level, or appearance resulting from the field application of paint or any other finishing material.
4. Warp not exceeding 1/4" in the plane of the door itself. Warp shall include bow, cup and twist. For doors larger than 3/0 x 7/0, warp not exceeding 3/8" in the plane of the door itself. Warp for 3/8" flat panel door over 3/0 wide.
5. Doors left unfinished at the job site and exposed to the sun or excessive cold, heat, or moisture.
6. Radius top doors for warp or exterior applications.
7. Doors with design one side / flush slab one side.
8. Glass or Mirror – breakage once doors have been received.
9. Failure to drill pilot holes for all hardware attachment screws.
10. Failure to follow Care & Finishing, Installation, and Maintenance Instructions.
11. Specialty doors, such as Glass, Louver, Mirror, Marking Board when used in exterior applications.
12. Modification of doors outside standard hardware preps and/or adding material (such as mirror of molding) to the doors.
13. Cutting doors more than 1" in height and/or more than a total of 1/4" in width.
14. Damage beyond the control of American Building Supply, Inc., including but not limited to, mishandling, shipping caused breakage, cracking or scratching; normal wear and tear, customer misuse, abuse, neglect or alteration; acts of nature including, but not limited to, fires, floods, earthquakes, wind, etc.
15. Barn door application.

There are no warranties that extend beyond the foregoing, and the manufacturer's responsibility under this warranty is as stated herein. No dealer, distributor or person other than the manufacturer has the right to alter this warrant verbally or in writing. The manufacturer shall not be liable for consequential, indirect or incidental damage, or for any amount in excess of the manufacturer's price for the doors involved, whether the claim is for breach of warranty or negligence.

In order to provide our customers with the finest products, manufactured in the most up-to-date manner, American Building Supply reserves the right to make design or specific construction changes without notice.

CARE, FINISHING & INSTALLATION

Care & Finishing Instructions (WDMA Recommendations):

1. Acclimatize - Prior to painting, insure that the building atmosphere is dried to a normal interior relative humidity and temperature. Insure that the doors have been allowed to equalize to stable moisture content.
2. Storage - Doors should always be stored flat and in a clean dry surrounding with spacing to allow for proper ventilation. Doors should not be stored directly on concrete or leaned against walls.
3. Preparation - Doors should not be considered ready for painting when initially received. Prior to painting, remove all handling marks, raised grain, and other undesirable blemishes by completely block sanding all surfaces with 180-220 grit sand paper or fine sanding sponges and spot prime as needed. Be sure not to sand through the factory primer.
4. Seal Door - All exposed surfaces must be sealed, including the top and bottom rails. Cut outs for hardware in doors must be sealed prior to installation of hardware.
5. Between Coats - Insure that the door surfaces being painted are satisfactory in both smoothness and color before applying the next coat. Sand if necessary and be sure that each coat is hard and dry before applying the next coat.
6. Paint Selection - On factory primed doors, a waterborne all acrylic latex finish is most compatible with the primers used and is highly recommended. Always obtain and follow paint manufacturers recommendations. Never attempt to paint in high moisture conditions, for the paint will not dry quickly enough and will penetrate into the door and can cause expansion and surface irregularities such as fiber raise.
7. Exterior Application - When painting exterior doors (Infinity only), two coats of high quality exterior sealer or primer must be used. Top and bottom rails, edges, faces, hardware cutouts, light and louver cutouts must be sealed prior to finish painting. This must be done as soon as the doors arrive at the job site. To prevent warping, avoid dark colors and have adequate overhang to protect the doors from the elements. Infinity doors must be ordered with exterior sealant applied at factory or warranty will be voided.
8. Painting - Apply a minimum of two coats of high-grade latex or enamel appropriate for the application to all six sides. During paint application process doors should be stood straight up or hanging. Do not lean doors or lay doors down without equal support throughout the door to avoid warpage. Insure that the environment that the doors are painted in is dry and at a temperature recommended by paint manufacturer.
9. Test Door - Always only paint ONE door to assure quality first before continuing on. ABS-Mfg must be contacted immediately if any quality issues are noticed.

Maintenance:

1. Most finishes on exterior doors deteriorate relatively quickly. Inspect the condition of exterior finishes at least once a year and refinish as often as needed to maintain the protective integrity of the finish.
2. Insure that the doors continue to swing freely and that all hardware remains functional.

Installation:

1. The utility or structural strength of the doors must not be impaired in fitting to the opening, in applying hardware, in preparing for lites, louvers, plant-ons or any other detailing.
2. Use two hinges for door up to 60" in height, three hinges for doors up to 90" in height and an additional hinge for every additional 30" of door height or portion thereof. Use heavy weight hinges on doors over 175 pounds. For special 90 minute rated doors special hinge applications apply due to excessive door weight.
3. Clearance between door edges and door frame should be a minimum of 1/16" on hinge edge. For latch edge and top rail the clearance should be 1/8".
4. All hardware locations, preparations for hardware and methods of hardware attachment must be appropriate for the specific door construction. Templates for specific hardware preparation are available from hardware manufacturers or their distributors.

5. When lite or louver cutouts are made for exterior doors, they must be protected in order to prevent water from entering the door core. Metal flashing on cutouts is required.
6. Pilot holes must be drilled for all screws that act as hardware attachments. Threaded to head screws, are preferable for fastening hardware to non rated doors and are required on all fire rated doors.
7. In fitting for height, do not trim top or bottom edge more than 3/4" unless accommodated by addition blocking. Never trim the top edge of a fire rated door.
8. Doors and door frames must be installed plumb, square and level.
9. For installation of any fire rated door see "Fire Door Installation - see #12 below".
10. Fire door installation:
 - NFPA 80, Fire doors and Windows, 1995 Edition, requires that all fire doors and frames be prepared under an inspection service.
 - 10.1 All components of an opening must have a certification label or certification mark to identify as a fire rated component. This identification MUST be applied at the point of manufacture or at an authorized machining distributor. FIELD LABELING OF ANY COMPONENT BY ANYONE OTHER THAN THE INSPECTION AGENCY SHALL VOID THE LABEL.
 - 10.2 The lowest rating of any component determines the rating for the total assembly. (I.e. if a 1 hour door is installed in a 20 minute frame, the maximum rating for the total assembly would be 20 minutes.)
 - 10.3 The clearance between the door and the frame and between meeting edges of doors swinging in pairs shall not exceed 1/8 inch. The clearance under the bottom of the door shall be as follows. Any trimming for height may be done on the bottom rail only (per NFPA 80, maximum trim of 3/4" - 19.0mm allowed on site).
 - 10.3.1 The clearance between the bottom of the door and a raised noncombustible sill shall not exceed 3/8".
 - 10.3.2 Where there is no sill, the clearance between the bottom of the door and the floor shall not exceed 3/4".
 - 10.3.3 The clearance between the bottom of the door and the rigid floor tile shall not exceed 5/8".
 - 10.3.4 The clearance between the bottom of the door and the nominal surface of floor covering shall not exceed 1/2".
 - 10.4 Job site modification is restricted to the following.
 - 10.4.1 Function holes for mortise locks, and mounting holes for hardware not to exceed 1" in diameter.
 - 10.4.2 Holes for labeled viewers.
 - 10.4.3 Protection plates and preparation of surface mounted hardware.
 - 10.4.4 A maximum of 3/4" undercutting of BOOK HEIGHT on particle board and mineral core doors.
 - 10.4.5 Pilot holes MUST be drilled for all screw applications.
- 10.5 Fire doors, with wood, particleboard, or mineral core are manufactured with the same size top and bottom rails, so that either end of the door can be the top. If there is an exception, the rails will be identified, and the top of the door must not be trimmed.
- 10.6 Positive pressure assemblies require the following.
 - 10.6.1 To qualify for smoke and draft assemblies (PER UBC STD 7-2 1997) the doors must have the secondary "S" label and be installed with listed gasketing that meets (UBC STD 7-2 1997 Part 2) for 20 Minute only.
 - 10.6.2 Approved intumescent smoke seals must be applied to the sides and top of the frame, and to the meeting edge of the inactive leaf of doors hung in pairs for Category B. When Category A doors are used, intumescent gasketing is not required.
 - 10.6.3 See installation instructions provided with the approved intumescent smoke seals, which are used.
- 10.7 Latch sets must have a minimum throw of 1/2" NFPA 80 Table 2-8.2.3 states that the latch throw for pairs must be 3/4". The minimum latch throw is stated on the certification label.
- 10.8 Hinges to be installed per NFPA 80 Table 2-8.1.1. Two hinges are required for a 60" high door and one additional hinge is required for each additional 30" or fraction thereof. The size and thickness of the hinges are covered in the table.

- 10.9** Closers attached to mineral composite or particleboard core doors usually must be through bolted. An exception to this would be when the doors have interior blocking that would permit the closures to be attached with screws.
- 10.10** When vision lights are installed in a fire door, the cutout must be done at the manufacturing facility or machining facility. Cutting the door for lights in the field is not allowed unless the preparation is performed under an inspection and a labeling program. Only certified fire rated glass, which is installed in approved frame shall be used. Only glazing labeled for fire may be used, and must be installed in accordance with their individual listing.
- 10.11** Fire doors equipped with automatic louvers shall be used only for protecting openings in required enclosures when the opening is not in a means of egress or otherwise located so that products of combustion flowing through the opening could jeopardize the use of exits prior to the operation of the louver. 20 minute fire rated doors are not permitted to have louvers.
- 10.12** Wrap around steel edges with an astragal must be applied to meeting edges of pairs, unless the certification label specifically states that they are not needed. 20 minute doors can usually be installed in pairs with metal steel meeting edges without an astragal. Steel meeting edges should be 18 or 20 gauge, with a minimum lap of 1". Attachment should be with 3/4" No. 8 screws, 12" on center. Mortise edge guards are not allowed unless included in the individual listing. When intumescent meeting edges are used, metal edges are not required.
- 10.13** Certification labels are attached at the point of manufacturer or under an inspection service and **MUST NOT** be removed or replaced except by authorized representatives of the inspection agency. Labels will be applied on the hinge stile at eye level.
- 10.14** Intumescent Layered Core 45, 60 & 90 fire doors use requires the following additions and exclusions of above sections:
- 10.14.1** Intumescent core fire doors **MUST** be manufactured to net size, no undercutting is allowed. This exception modifies 10.4.4 above.
- 10.14.2** It is mandatory that hinges be installed per these instructions. 6/8 and 7/0 in height must be installed with three minimum and doors over 7/0 in height must have four minimum. Hinges must be 4-1/2" x 4-1/2" heavy weight, .180 depth, and 2" x #12 wood screws used. All 45, 60 & 90 minute Intumescent layered core doors will have hinge screw pilot holes drilled at the factory.
- 10.14.3** Millennium 45, 60 & 90 minute (Intumescent layered core) doors are heavy. Please take the proper precautions when installing these doors. Extra help and care should be given due to the weight of the door.





THE
MILLENNIUM[®]
COLLECTION

888-454-2888
millenniumdoors.com