

# SLIDING SCREEN DOORS

## PRODUCT PAGE

Aluminum roll form sliding screen door (assembled / KD) ..... 62

Extruded aluminum sliding screen doors (assembled / KD) ..... 62-64

Steel roll form sliding screen doors (assembled) ..... 64-65

Maui vinyl sliding screen door (assembled / KD) ..... 65

Custom options for sliding screen doors (assembled / KD) ..... 66-67

Door list ..... 68

Top hung universal mounting channel ..... 69

Sliding screen channels and astragals ..... 70

Sliding screen door measuring worksheet ..... 71

Sliding screen door order form ..... 72

**Features**

- 1-5/8" Roll form aluminum frame
- Black plastic **Anjac** handle assembly with strike plate & installation screws
- Non-handed with handle centered
- Stamped steel corners
- Charcoal fiberglass insect screening (on assembled doors)
- 1" Nylon spring tension roller with adjustment screw (plastic inserts are no longer standard)
- Extruded vinyl bug seal with flap & tear-off strips
- Assembled & K.D. widths available up to 61"
- Assembled & K.D. heights available up to 97" (specify handle height on doors over 84" tall)
- Precision SAFEGUARD packaging - complete with hardware (on assembled doors)

**Standard Finishes**

- Bronze, gray or white powder coated **Call for quote on any sizes or options not shown**

**3100 (Assembled)**  
Product Line: D3301

Door size up to

37" x 81"	37" x 97"
49" x 81"	49" x 97"
61" x 81"	61" x 97"

**4100 (KD) \***  
Product Line: D3310

Door size up to

31" x 81"	31" x 97"
37" x 81"	37" x 97"
49" x 81"	49" x 97"
61" x 81"	61" x 97"

For KD kits - **Convenient six pack packaging:**  
Deduct \$2.00 per door (subject to discount)  
\*All rails are miter cut

**Roll Form Aluminum Screen Door**

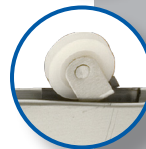

**Features**

- 1-3/4" .050 Extruded aluminum frame (fluted)
- Extruded aluminum handle assembly with mortise lock & lever latch
- Non-handed with handle centered
- Extruded aluminum spur corners
- Charcoal fiberglass insect screening (on assembled doors)
- 1" Steel ball bearing spring tension roller with adjustment screw (plastic inserts are no longer standard)
- Extruded vinyl bug seal with flap & tear-off strips
- Assembled & K.D. widths available up to 73"
- Assembled & K.D. heights available up to 110" (specify handle height on doors over 84" tall) **Extra charges will apply for doors over 97" in height**
- Precision SAFEGUARD packaging - complete with hardware (on assembled doors)

**Standard Finishes**

- Adobe, almond, black, bronze or white powder coated • Satin anodized

*Call for quote on any sizes or options not shown*

**3200 (Assembled)**  
Product Line: D3302

Door size up to\*

37" x 81"	37" x 97"	37" x 110"
49" x 81"	49" x 97"	49" x 110"
61" x 81"	61" x 97"	61" x 110"
73" x 81"	73" x 97"	73" x 110"

**4200 (KD) \*\***  
Product Line: D3311

Door size up to\*

31" x 81"	31" x 97"	31" x 110"
37" x 81"	37" x 97"	37" x 110"
49" x 81"	49" x 97"	49" x 110"
61" x 81"	61" x 97"	61" x 110"

\*Doors over 97" tall are subject to an additional charge

For KD kits - **Convenient six pack packaging:**  
Deduct \$2.00 per door (subject to discount)

\*\*Miter cut service available for an additional charge

**Extruded Aluminum Screen Door**

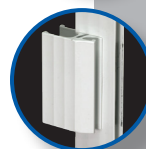

Extruded Aluminum Screen Door

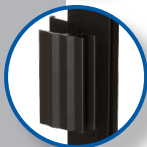
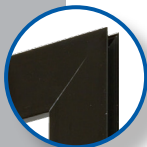

### Features

- 1-3/4" .050 Extruded aluminum frame
- Extruded aluminum handle assembly with mortise lock & lever latch
- Non-handed with handle centered
- Heavy duty diecast corners with side adjustment
- Charcoal fiberglass insect screening (on assembled doors)
- 1-1/4" Steel ball bearing rollers
- Extruded vinyl bug seal with flap & tear-off strips
- Assembled & K.D. widths available up to 73"
- Assembled & K.D. heights available up to 110" (specify handle height on doors over 84" tall) **Extra charges will apply for doors over 97" in height**
- Precision SAFEGUARD packaging - complete with hardware (on assembled doors)

### Standard Finishes

- Adobe, almond, black, bronze or white powder coated
- Bronze or satin anodized

Call for quote on any sizes or options not shown

#### 3300 (Assembled)

Product Line: D3302

Door size up to\*

37" x 81"	37" x 97"	37" x 110"
49" x 81"	49" x 97"	49" x 110"
61" x 81"	61" x 97"	61" x 110"
73" x 81"	73" x 97"	73" x 110"

\*Doors over 97" tall are subject to an additional charge

#### 4300 (KD) \*\*

Product Line: D3311

Door size up to\*

31" x 81"	31" x 97"	31" x 110"
37" x 81"	37" x 97"	37" x 110"
49" x 81"	49" x 97"	49" x 110"
61" x 81"	61" x 97"	61" x 110"

For KD kits - Convenient six pack packaging: Deduct \$2.00 per door (subject to discount)

\*\*Miter cut service available for an additional charge

# MARQUIS (Series 3400 Assembled / 4400 KD)

Extruded Aluminum Screen Door

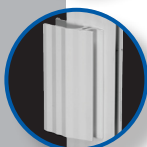

### Features

- 2-1/2" .060 Extruded aluminum frame (fluted)
- Extruded aluminum handle assembly with mortise lock & lever latch
- Extruded aluminum spur corners
- Charcoal fiberglass insect screening (on assembled doors)
- 1" Steel ball bearing spring tension top rollers
- 1-1/4" Steel ball bearing bottom rollers
- Extruded vinyl bug seal with flap & tear-off strips
- **Specify handing: latch side, left or right as outside looking in**
- Assembled & K.D. widths available up to 73"
- Assembled & K.D. heights available up to 110" (specify handle height on doors over 84" tall) **Extra charges will apply for doors over 97" in height**
- Precision SAFEGUARD packaging - complete with hardware (on assembled doors)

### Standard Finishes

- Adobe, almond, black, bronze or white powder coated
- Satin anodized *Call for quote on any sizes or options not shown*

#### 3400 (Assembled)

Product Line: D3302

Door size up to\*

37" x 81"	37" x 97"	37" x 110"
49" x 81"	49" x 97"	49" x 110"
61" x 81"	61" x 97"	61" x 110"
73" x 81"	73" x 97"	73" x 110"

\*Doors over 97" tall are subject to an additional charge

#### 4400 (KD) \*\*

Product Line: D3312

Door size up to\*

31" x 81"	31" x 97"	31" x 110"
37" x 81"	37" x 97"	37" x 110"
49" x 81"	49" x 97"	49" x 110"
61" x 81"	61" x 97"	61" x 110"

\*\*Miter cut service available for an additional charge

**Features**

- 2-1/4" x 1" .050 Extruded "hat section" style aluminum frame (smooth)
- Recessed handle assembly with mortise lock & slide latch
- Non-handed with handle centered
- Extruded aluminum spur corners
- Charcoal fiberglass insect screening (on assembled doors)
- 1-1/4" Steel ball bearing rollers
- Extruded vinyl bug seal with flap & tear-off strips
- Assembled & K.D. widths available up to 73"
- Assembled & K.D. heights available up to 110" (specify handle height on doors over 84" tall) **Extra charges will apply for doors over 97" in height**
- Precision SAFEGUARD packaging - complete with hardware (on assembled doors)

**Standard Finishes**

- Adobe, almond, bronze or white powder coated
- Satin anodized

Call for quote on any sizes or options not shown

3500 (Assembled) Product Line: D3302		
Door size up to*		
37" x 81"	37" x 97"	37" x 110"
49" x 81"	49" x 97"	49" x 110"
61" x 81"	61" x 97"	61" x 110"
73" x 81"	73" x 97"	73" x 110"

\*Doors over 97" tall are subject to an additional charge

4500 (KD) ** Product Line: D3312		
Door size up to*		
31" x 81"	31" x 97"	31" x 110"
37" x 81"	37" x 97"	37" x 110"
49" x 81"	49" x 97"	49" x 110"
61" x 81"	61" x 97"	61" x 110"

\*\*Miter cut service available for an additional charge

Extruded "Hat Section" Aluminum Screen Door

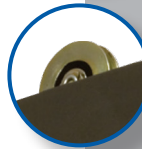
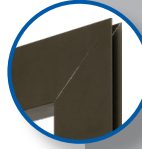

(Series 3700 Assembled) BREEZEWAY

**Features**

- 1-5/8" Roll form steel frame
- Height adjustable from 79-3/8" to 80-3/4" (for height adjustments between 78-1/2" and 79", remove top hood assembly)
- 30", 36" & 48" Standard sizes
- Black plastic "Precision" handle assembly
- Non-handed
- Stamped steel corners
- Charcoal fiberglass insect screening
- Nylon spring tension roller assembly
- Top roller attached to adjustment channel
- Extruded vinyl bug seal with flap & tear-off strips
- No custom sizes or options
- Precision SAFEGUARD packaging - complete with hardware

**Standard Finishes**

- Bronze, gray or white

Economy Roll Form Steel Screen Door



3700 (Assembled)  
Product Line: D3005

Standard sizes available

30"
36"
48"

### Economy Roll Form Steel Screen Door



### Features

- 1-5/8" Roll form steel frame with hat section
- Height adjustable from 79-3/8" to 80-3/4" (for height adjustments between 78-1/8" and 79", remove top hood assembly)
- 36" & 48" Standard size only
- Black plastic "Superior" handle assembly
- Non-handed
- Stamped steel corners
- Charcoal fiberglass insect screening
- Nylon spring tension roller assembly
- Extruded vinyl bug seal with flap & tear-off strips
- No custom sizes or options
- Precision SAFEGUARD packaging - complete with hardware

### Standard Finishes

- Bronze, gray or white

**3751 (Assembled)**  
Product Line: D3005

Standard sizes available	
36"	
48"	

# MAUI (Series 3600 Assembled / 4600 KD)

### Reinforced Vinyl Screen Door

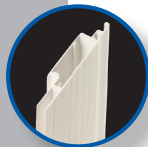

### Features

- 2-1/4" x 1" Reinforced vinyl frame (smooth)
- Black plastic handle assembly
- Non-handed with handle centered
- Factory welded corners on assembled doors
- Heavy duty PVC corners with KD kits
- Charcoal fiberglass insect screening (on assembled doors)
- 1" Stainless steel ball bearing rollers with stainless steel adjusting screws
- Extruded vinyl bug seal with flap & tear-off strips
- **Specify handing: latch side, left or right as viewed from outside looking in**
- Assembled & K.D. widths available up to 61"
- Assembled & K.D. heights available up to 96"
- Corrosion resistant
- Cannot use Suntex on this door series
- Precision SAFEGUARD packaging - complete with hardware (on assembled doors)

### Standard Finishes

- White vinyl

*Call for quote on any sizes or options not shown*

**3600 (Assembled)**  
Product Line: D3600

Door size up to: *	
37" x 81"	37" x 96"
49" x 81"	49" x 96"
61" x 81"	61" x 96"

**4600 (KD)**  
Product Line: D3600

Door size up to:	
37" x 81"	37" x 96"
49" x 81"	49" x 96"
61" x 81"	61" x 96"

\*Dimension tolerances on assembled doors +/- 3/32" (3/16" overall)

# SLIDING SCREEN DOORS

## Custom options (add-ons)









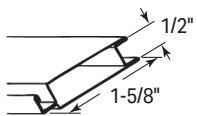

Option	Option Code	Description
<b>Door frame options</b>	OP-1PB-1	Install 1 each #288PB – 1-1/8" extruded push bar
	OP-1PB-2	Install 2 each #288PB – 1-1/8" extruded push bar
	OP-CRNSCR	Install 4 screws in each corner; total 16 screws
	OP-NOSLOT-HARDW	No latch, handles, rollers; no punch or slotting
	OP-SLSLOT4HNDL	Sliding door handle height; punch XX-x/x" up from bottom to
<b>Roller options</b>	OP-CLASSIC-N	Install classic side adjust nylon rollers (#477002N)
	OP-MARQUIS-NB	Slot & install Marquis nylon ball bearing rollers bottom (#4828N)
	OP-MARQUIS-NT	Slot & install Marquis nylon ball bearing rollers top (#4830)
	OP-MARQUIS-NTB	Slot & install Marquis nylon ball bearing rollers top & bottom (#4830 & #4828N)
	OP-MARQUIS-SB	Slot & install Marquis steel ball bearing rollers bottom (#4828)
	OP-MARQUIS-ST	Slot & install Marquis steel ball bearing rollers top (#4830)
	OP-MARQUIS-STB	Slot & install Marquis steel ball bearing rollers top & bottom (#4830 & #4828)
	OP-MARQUIS-SSB	Slot & install Marquis stainless steel ball bearing rollers bottom (#4828SS)
	OP-MARQUIS-SST	Slot & install Marquis stainless steel ball bearing rollers top (#4830SS)
	OP-MARQUIS-SSTB	Slot & install marquis stainless steel ball bearing rollers top & bottom (#4830SS & #4828SS)
	OP-REGAL-S	Install Regal steel rollers top & bottom #4131
	OP-REGAL-SS	Install Regal stainless steel ball bearing rollers #4131-SS
<b>Handing options</b>	OP-HNDLLEFT	XO"" Handle left from the outside looking in
	OP-HNDLRIGHT	OX"" Handle right from the outside looking in
<b>Handle options</b>	OP-1HNDL4227	Install Anjac handle #4227
	OP-2HNDL4227	Install Anjac handle #4227
	OP-1HNDL4230	Install Superior handle #4230
	OP-1HNDL4736	Install latch & flush handle inside & out #4736 w/latch
	OP-1HNDL4736-NS	No slot/no latch, install flush handles inside & out #4736
<b>Grille options</b>	OP-GREMPRESS-30	Install Empress heavy duty grille 30"
	OP-GREMPRESS-36	Install Empress heavy duty grille 36"
	OP-GREMPRESS-48	Install Empress heavy duty grille 48"
	OP-GREMPRESS-60	Install Empress heavy duty grille 60"
	OP-GRFIESTA-30	Install Fiesta grille 30"
	OP-GRFIESTA-36	Install Fiesta grille 36"
	OP-GRFIESTA-48	Install Fiesta grille 48"
	OP-GRFIESTA-60	Install Fiesta grille 60"

# SLIDING SCREEN DOORS

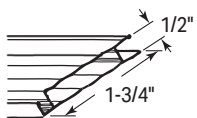
Custom options (add-ons)

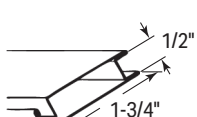
Option	Option Code	Description
<b>Pet door options</b>	OP-PD-SLD-S	Install pet door handle side – small w/adapter
	OP-PD-SLD-M	Install pet door handle side – medium w/adapter
	OP-PD-SLD-L	Install pet door handle side – large w/adapter
<b>Pet door colors</b>	OP-AD	Adobe
	OP-AL	Almond
	OP-BZ	Bronze
	OP-SA	Satin anodized
	OP-WH	White
<b>Screen cloth options</b>	OP-SC14CF	Screen cloth charcoal fiber 18" x 14"
	OP-SC14GF	Screen cloth gray fiber 18" x 14"
	OP-SC16BA	Screen cloth brite aluminum 18" x 16"
	OP-SC16BV	Screen cloth better vue
	OP-SC16CA	Screen cloth charcoal aluminum 18" x 16"
	OP-SC16CF	Screen cloth charcoal fiber 18" x 16"
	OP-SC16GF	Screen cloth gray fiber 18" x 16"
	OP-SC16UV	Screen cloth ultra vue
	OP-SC20CF	Screen cloth charcoal fiber 20" x 20"
	OP-SCD	Delete screen cloth & spline; door shell only
	OP-SCPSBK	Screen cloth black petscreen
	OP-SCPSLBK	Screen cloth black petscreen lite
	OP-SCPSGR	Screen cloth gray petscreen
	OP-SCSSCF	Screen cloth charcoal sunscreen
	OP-SCSSGF	Screen cloth gray sunscreen
	OP-SCSTBK	Screen cloth black sun tex 80%
	OP-SCSTBR	Screen cloth brown sun tex 80%
	OP-SCSTGR	Screen cloth gray sun tex 80%
OP-SCSTST	Screen cloth stucco sun tex 80%	

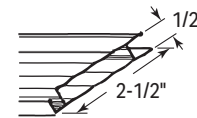
# SLIDING SCREEN DOORS Assembled lines only

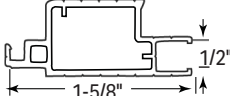
Name/ Series	Product Line	Description	Name/ Series	Product Line	Description
Brentwood 3100 Page 62	D3301	 <p>1-5/8" Roll form aluminum frame Custom widths 37" up to 61", Heights up to 97" Black plastic <i>Anjac</i> handle assembly with strike plate &amp; installation screws Bronze, gray or white No custom colors available for this door</p> 	Prestige 3500 Page 64	D3302	 <p>2-1/4" x 1" .050 Extruded "hat section" style aluminum frame (smooth) Custom widths 37" up to 73", Heights up to 110"* Recessed handle assembly with mortise lock &amp; slide latch Adobe, almond, bronze or white Satin anodized No custom colors available for this door</p> 
Regal 3200 Page 62	D3302	 <p>1-3/4" .050 Extruded aluminum frame (fluted) Custom widths 37" up to 73", Heights up to 110"* Extruded aluminum handle assembly with mortise lock &amp; lever latch Adobe, almond, black, bronze or white Satin anodized No custom colors available for this door</p> 	Breezeway 3700 Page 64	D3005	 <p>1-5/8" Roll form steel frame Available in 30", 36" &amp; 48" only Black plastic "<i>Precision</i>" handle assembly Bronze, gray or white  No custom sizes or colors available for this door</p>
Classic 3300 Page 63	D3302	 <p>1-3/4" .050 Extruded aluminum frame Custom widths 37" up to 73", Heights up to 110"* Extruded aluminum handle assembly with mortise lock &amp; lever latch Adobe, almond, black, bronze or white Bronze or satin anodized No custom colors available for this door</p> 	Branson 3751 Page 65	D3005	 <p>1-5/8" Roll form steel frame with hat section Available in 36" &amp; 48" only Black plastic "<i>Superior</i>" handle assembly Bronze, gray or white No custom sizes or colors available for this door</p>
Marquis 3400 Page 63	D3302	 <p>2-1/2" .060 Extruded aluminum frame (fluted) Custom widths 37" up to 73", Heights up to 110"* Extruded aluminum handle assembly with mortise lock &amp; lever latch Adobe, almond, black, bronze or white Satin anodized No custom colors available for this door</p> 	Maui 3600 Page 65	D3600	 <p>2-1/4" x 1" Reinforced vinyl frame (smooth) Custom widths 37" up to 61", Heights up to 96"  Black plastic handle assembly Corrosion resistant White No custom colors available for this door</p> 

**\*Extra charges will apply for doors over 97" in height**



# TOP HUNG UNIVERSAL MOUNTING CHANNEL

For sliding screen doors

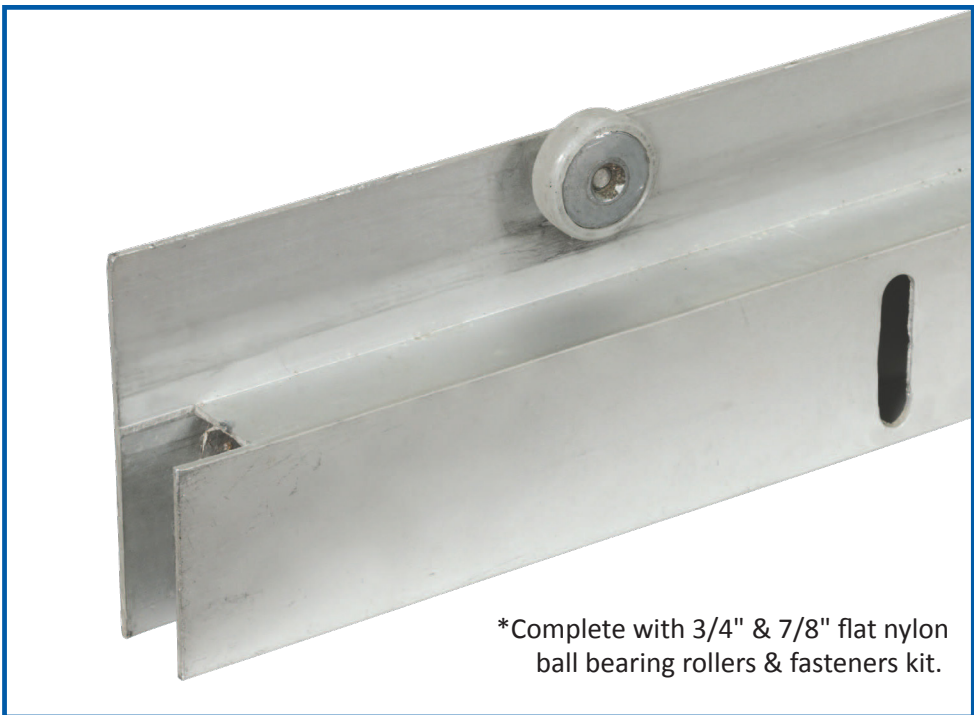
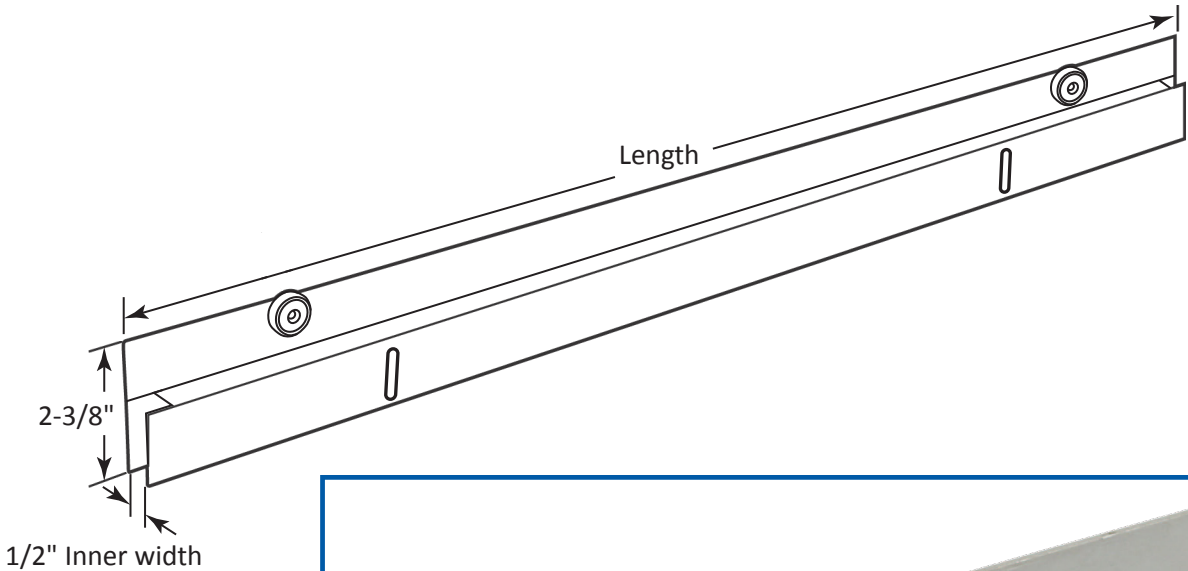

❖ **FITS MOST DOOR SERIES**  
BRENTWOOD, REGAL, CLASSIC, MARQUIS

- 4848AD-36
- 4848AL-36
- 4848BZ-36
- 4848SA-36
- 4848WH-36

- 4848AD-48
- 4848AL-48
- 4848BZ-48
- 4848SA-48

4848WH-48

# SLIDING SCREEN COMPONENTS

Color code chart (xx)		
AD = Adobe	BK = Black	ML = Mill
AL = Almond	BZ = Bronze	SA = Satin anodized
BA = Bronze anodized	GR = Gray	WH = White

Part No.	Product Line	Description	Drawing
4180xx	F3874	5/8" x 1" Top single track 12' <i>(Available in all colors except gray)</i>	
4181xx	F3874	5/8" x 1" Top double track 12' <i>(Available in all colors except gray)</i>	
4184xx	F3874	Bottom double track 12' <i>(Available in all colors except gray)</i>	
4185xx	F3874	Single bottom track 12' <i>(Available in all colors except gray)</i>	
4189WH-8 4189WH	F3870 F3870	Extruded vinyl track 8' Extruded vinyl track 16' <i>(Available in white only)</i>	
4195xx	F3874	5/8" x 1/2" Top single track 12' <i>(Available in all colors except gray)</i>	
4198xx-84 4198BK-96 4198xx-100	F3874 F3874 F3874	Rigid vinyl astragal - 84" (all available colors) Rigid vinyl astragal - 96" (black only) Rigid vinyl astragal - 100" (AL not available) <i>(Available colors: AD, AL, BK, BZ, GR &amp; WH)</i>	
4199xx84 4199xx	F3874 F3874	<b>Used for extruded sliders</b> Extruded screen astragal - 7' Extruded screen astragal - 8' <i>(Available in all colors except gray)</i>	

# SLIDING PATIO SCREEN DOOR

## Measuring worksheet

**Step #1**

### Determine type of header:

Determine what type of header you have; **Top "track"** or **Top "channel"** from the 2 examples in *Diagram A* on the right.

\*Note: If your door is something other than either of the examples in *Diagram A*, we recommend using Lowe's Installation professionals.

**1.**

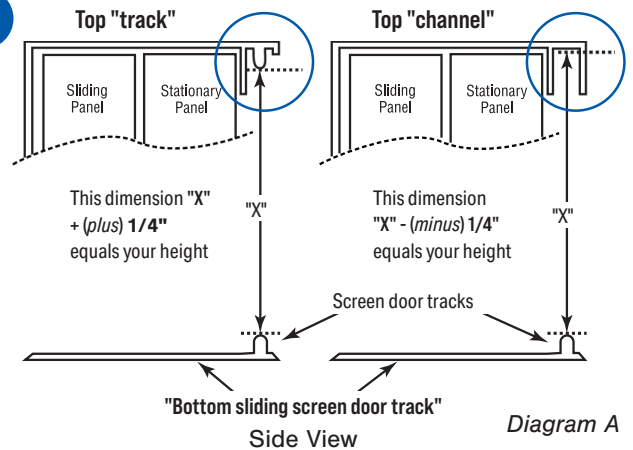

*Diagram A*

**Step #2**

### Determine Door Height:

To determine the height of your door, measure from the top of the screen door **Top "track"** or **Top "channel"** to the top of the **"bottom sliding screen door track"** as shown. Make height measurements in 3 locations, the center and each end. There may be some "Sag", "Dip" or "Crown" along the door frame on older homes, so use the **SHORTEST** measurement for the final height of your door using the formula in *Diagram A*.

**Example:** using *Diagram A* formulas and shortest measurement for a door being 80":

**"track"** formula:  $80" + 1/4" = 80-1/4"$

**"channel"** formula:  $80" - 1/4" = 79-3/4"$

**Net Door Height:** \_\_\_\_\_ "

**2. Determine Height**

**3. Determine Width**

**Step #3**

### Determine Door Width:

To determine the width, measure from the edge of the side jamb to approximately 1" past the "sliding" glass door panel (see *Diagram B*)

**Net Door Width:** \_\_\_\_\_ "

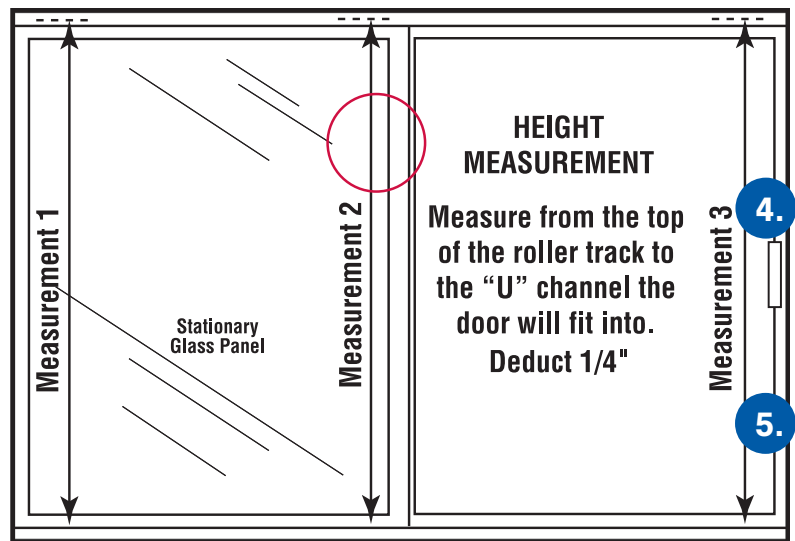

Outside view looking in

**Step #4**

### Handle:

Please specify placement as either left or right as seen looking from the outside of the door in. (*Right hand showing in diagram*)

**Handle side:**  Left  Right

**Step #5**

### Handle Height:

Handle will be centered unless specified. To order a special handle height placement, measure from the bottom of the door to center of handle.

**Special Handle Height:** \_\_\_\_\_ "

(*Not required for normal installations*)

1" past the "sliding" glass door panel.

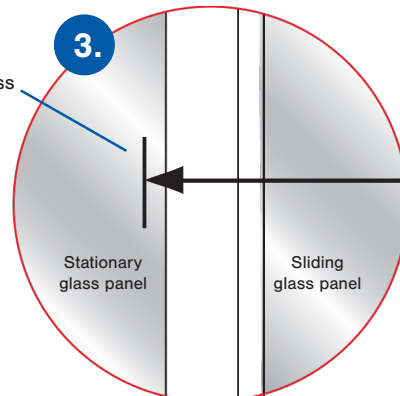

*Diagram B*

**Note:** If you have an existing OEM Screen Door, compare your measurements with the size of the door that you are replacing.

Phone (619) 271.2222 | sales@glahs.com

Customer Name \_\_\_\_\_ Acct # \_\_\_\_\_ Customer Phone# \_\_\_\_\_

Contact Name \_\_\_\_\_ Customer Fax # \_\_\_\_\_

PO # Job/Customer Name \_\_\_\_\_  QUOTE ONLY  ORDER

Qty	Net Door Size	Door Name	Door Color	Screen (Fabric / Color)	Handle Side	Handle Height	Notes & Options Instructions

\*Note: Specify Handle side from the outside looking in.