

Schlage - *Dexter Residential*

Deadbolt Locks - *ANSI A156.5, 1992 Grade 3*

- C keyway 5 pin, 1-3/8" - 1-3/4" thick door
- Provided double option: square corner, or 1/4" radius Adjustable 2-3/8" - 2-3/4" backset
- 2-1/8" bore size

JD60

Single Cylinder Deadbolt



JD60 ANSI E2153

Single Cylinder Deadbolt Deadbolt thrown or retracted by key from outside or by inside turn unit. Bolt automatically deadlocks when fully thrown.

JD80

Single Cylinder Deadbolt



JD80

One-sided Deadbolt
Deadbolt thrown or retracted from interior side only

Stocked Product

JD60 Finishes:

605,609,619,620,622,625,630,716

JD80 Finish: 619

Schlage - Dexter Residential

Locks Handlesets - ANSI A156.2, 1969, Series 4000, Grade 3

- C keyway 5 pin, 1-3/8" - 1-3/4" thick door
- Provided double option: square corner, or 1/4" radius Adjustable 2-3/8" - 2-3/4" backset

J Series Handlesets

JH58



JH59



JH58/JH59

Entrance Lock

Deadbolt thrown or retracted by key from outside or by inside turn unit. Latch retracted by thumbpiece from outside or by inside knob/lever.

Consist of:

JH58 - outside trim
JH59 - inside trim



J10 ANSI F75

Passage Latch

Both knobs/levers always unlocked.

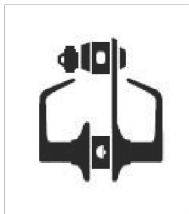

J18/19

Passage Lock with Keyed Deadbolt

Deadbolt operated by key from outside or by turn unit from inside. Bolt automatically deadlocks when fully thrown. Latch retracted by lever from either side. Turning inside lever retracts deadbolt and latch simultaneously for immediate exit



J40P ANSI F76

Bath/Bedroom Privacy Lock

Push-button locking. Can be opened from outside with small circular tool. Turning inside knob/lever releases button.



JI58/59

Keyed Entrance lock

Deadbolt operated by key from outside or by turn unit from inside. Bolt automatically deadlocks when fully thrown. Outside lever unlocked by key from outside when locked by turn button in inside lever. Turning inside lever retracts deadbolt and latch simultaneously for immediate exit. Latch automatically deadlocks when door is closed.



J54 ANSI F81

Entrance Lock

Unlocked by key from outside when outer knob is locked by turn-button in inside knob. Inside knob/lever is locked and unlocked by turn button.



J170 Single Dummy

Trim

Dummy trim for one side of door. Used for door pull or as matching inactive trim.



J40 ANSI F76

Bath/Bedroom Privacy Lock

Turn-button locking. Can be opened from outside by turning outside turn mechanism. Turning inside turn button releases inside knob/lever.

Schlage - Dexter Residential

Outside Trim Handlesets Active - *JH58 outside trim only*



BARCELONA
Symbol **BAR**



PARIS
Symbol **PAR**

Stocked Product

Barcelona JH58 605,609,619,622,625,630,716
Paris JH58 605,619,625,716

Handleset Inside Trim - *JH59 Active only*



CORONA
Symbol **CNA**



DOVER
Symbol **DOV**



LASALLE
Symbol **LAS** (Hand)



MARIN
Symbol **MAR**



SEVILLE
Symbol **SEV** (Handed)



SOLSTICE
Symbol **SOL**



SOLSTICE x COLLINS
Symbol **SOL x COL**



STRATUS
Symbol **STR**



TORINO
Symbol **TOR**



Stocked Products

Corona	JH59	609,619,625,630,716
Dover	JH59	630
La Salle	JH59	605,619,716
Marin	JH59	619
Seville	JH59	619, 625,716
Solstice	JH59	619, 625
Stratus	JH59	619,716
Torino	JH59	619,620,625,630,716
Solstice x Collins	JH59	622

Schlage - *Dexter Residential*

BYRON

Symbol **BYR**



CORONA

Symbol **CNA**



DOVER

Symbol **DOV**



LASALLE

Symbol **LAS** (Handed)



MARIN

Symbol **MAR**



SEVILLE

Symbol **SEV** (Handed)



SOLSTICE

Symbol **SOL**



STRATUS

Symbol **STR**



TORINO

Symbol **TOR**



SOLSTICE x COLLINS

Symbol **SOL x COL**



Stocked Product

DESIGNS

Byron J170, J10, J40, J54
 Corona J170, J10
 Corona J40, J54
 Dover J170, J10, J40, J54
 La Salle J170, J10, J40, J54
 Marin J170
 Marin J170, J10, J40, J54
 Seville J170, J10, J40, J54
 Seville J40P
 Solstice J170, J10, J54
 Solstice J40
 Solstice J40P
 Solstice x Collins J170, J10, J40, J54
 Stratus J170, J10, J40, J54
 Torino J170
 Torino J54
 Torino J10, J40
 Torino J40P

FUNCTIONS

FINISHES

605,630
 605,609,619,625,630,716
 605,609,619,620,625,630,716
 630
 605,609,619,716
 619
 619,630
 619,625,716
 619,716
 619,622,625,716
 619,622,625
 619,625,716
 622
 619,625,716
 619,620,630,716
 619,620,625,716
 619,620,625,630,716
 625,716

Schlage - *Dexter Residential*

Interconnected Lock - *J1 Series*



**J118/ J119
Marin**



**J158 /J159
Torino**

Applications:

Single and multi-family residential, office, hotel/motel, and light commercial applications.

Specifications:

- Interconnected latchbolt and deadbolt chassis
- Ideal for new construction
- 5 1/2" center to center cross-bore diameter
- Both latch and deadbolt are retracted simultaneously, allowing for emergency egress
- Product exceeds all ANSI A1 56.12 Grade 3 requirements
- UL Listed for all functions
- Non-handed Levers
- Adjustable latch for 2 3/8" or 2 3/4" backset
- Dexter offers a lifetime mechanical warranty

DOOR RANGE: 1 3/8" to 1 3/4" (35 mm-51 mm).

Stocked Products

Marin	J118	630
Marin	J119	630
Torino	J158	630
Torino	J159	630

Schlage - *Dexter Residential*

Strikes & Parts

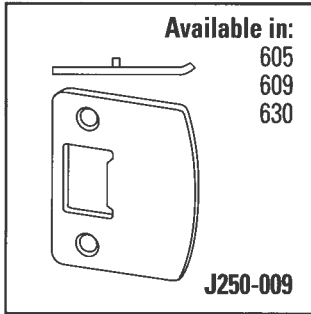

Radius corner full lip

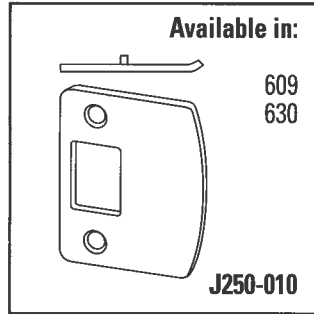

Radius full lip for JD60



J750-061
5 pin key blank
Schlage C Keyway

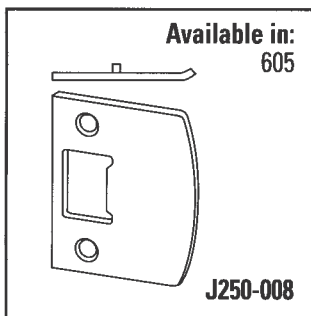

Square corner full lip



Square strike plate
and frame reinforcer
with 3" screws

Radius Corner Deadbolt Strikes

Stocked Products

J250-026: 605,609,630, 716

J250-027: 605,609,620,630

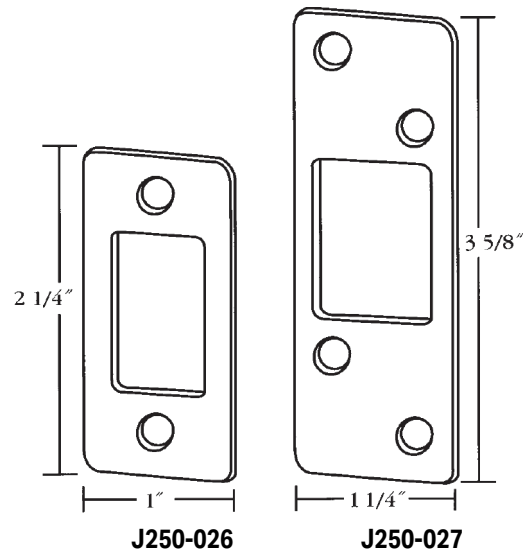

Schlage - B60 Deadbolts

B60 Series - Deadbolt

Three-piece design

Ready to go out of the box for quick installation.

Sleek

Low profile face is almost impossible to grab with a wrench and cannot be unscrewed.

Versatile

Shield is easily removed to fit 1 1/2" cross-bore prep.

Stronger

1/2" of bolt left in housing when bolt is thrown for added kick-in resistance.

Tougher

Thicker metal strike reinforcer has 3" screws for greater strength in the jamb.

Secure

Integrated anti-pick shield with SNAP & STAY™ self-adjusting tension provides added security and simplifies installation.

Required

1" door prep required for larger bolt housing.

UL Listed

Optional 3-hour UL Listed fire cup/latch available.

Streamlined

Deep drawn housing delivers a seamless piece of steel from beginning of helix to back of bolt for maximum latch/bolt reliability. Fits both 2 3/8" and 2 3/4" backsets.

Unprecedented

Adjustable backset has the industry's only helical design that locks into place with no adjusting during installation. Fits both 2 3/8" and 2 3/4" backsets.

Code Compliant

ADA compliant thumbturn.

Solid

Zinc bolt has hardened steel pin inside that spins in response to sawing attack and can't be cut through.

Bigger

Bolt diameter is 10% larger than typical bolts for maximum kick-in resistance.

Rounded

Radius corners on strike plate for more attractive installation. 1 1/8" x 2 3/4" round corner strikes come standard.

Available Functions:

B60 - Single cylinder dead bolt lock

B62 - Double cylinder dead bolt lock

B80 - Door bolt

B81 - Door bolt with trim (Special Order)

Designed to fit virtually any door.

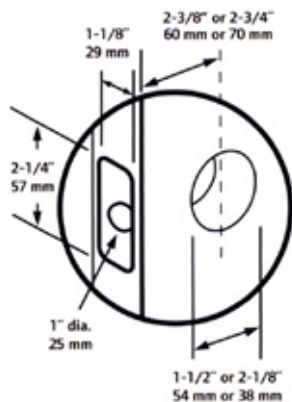

Standard door prep for B-Series installation.

Standard Strike



10-116*
1 1/8" x 2 3/4"

Schlage - B B Series - Deadbolt Locks - ANSI A156.5, 1992, Grade 2



B60 ANSI E2152 Single Cylinder Deadbolt Lock

Deadbolt thrown or retracted by key from outside or by inside turn unit. Bolt automatically deadlocks when fully thrown.



B62N ANSI E2142 Double Cylinder Deadbolt Lock

Deadbolt thrown or retracted by key from either side. Bolt automatically deadlocks when fully thrown.



B80 ANSI E2192 Door Bolt

Deadbolt thrown or retracted by turn unit only. No outside trim. Bolt automatically deadlocks when fully thrown.



B60 - Deadbolts and Collection Series Deadbolts

- C keyway 5 Pin
- Triple option face plates, square corner, round corner and circular
- Adjustable 2-3/8" or 2-3/4" BS
- Standard square corner 10-094 strike
- Door preparation 1-1/2" or 2-1/8"
- Door preparation 2-1/8" bore
- B80 - 1 1/2" Bore only
- B60 UL* UL listed for 3-hour fire door

Stocked Product:

ITEM	DESCRIPTION	FINISH
B60	Single Cylinder	505, 605, 609, 613, 619, 620, 621, 622, 625, 626, 716
B60 UL*	Single Cylinder	619, 716
B62	Double Cylinder	505, 605, 609, 613, 619, 620, 622, 625, 626, 716
B80	Door Bolt	605, 609, 619, 626, 716

Collection Series

B60 x Addison	Single Cylinder	619, 716, 625
B60 x Collins	Single Cylinder	619, 622



B60 x Addison (ADD)



B60 x Collins (COL)



Schlage - Strikes and Parts

B60 - Strikes

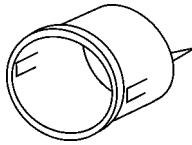

10-064
Thimble strike
circular drive-in

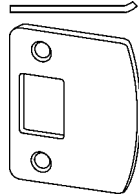

10-092
1/4" Radius
round corner
Full lip, no box
1-5/8" x 2-1/4"



10-094 Standard
Square corner
1-1/8" x 2-3/4" Standard

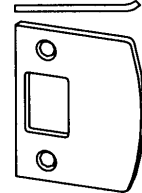

10-095
Square Corner Box
Full lip, no box
1-5/8" x 2-1/4"

Stocked Product

10-064	Thimble Strike 1-3/16" Diameter	626
10-092	Round Corner Full Lip Strike 1-5/8" X 2-1/4"	605, 609, 613, 619, 620, 625, 626
10-094	Square Corner Strike, 1-1/8" X 2-3/4"	605, 609, 613, 619, 620, 625, 626
10-095	Square Corner Full Lip Strike, 1-5/8" X 2-1/4"	605, 613, 619, 620, 626

B60 - Parts

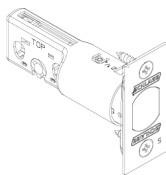

12-288 Square Corner
Adjustable Backset

12-288 Square Corner Bolt, 2-3/8"-2-3/4" BS,
1" X 2-1/4" Face Plate

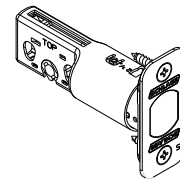

12-289 1/4" Round Corner
Adjustable Backset

12-289 1/4" Round Corner Bolt, 2-3/8"-2-3/4" BS,
1" X 2-1/4" Face Plate
12-633 Square Corner Bolt, 5" BS,
1" X 2-1/4" Face Plate

Stocked Product

12-288	605, 626, 613, 619
12-289	605, 626, 613, 619
12-633	613, 626

Schlage - BE/FE

BE/FE Series - Keypad Locks



BE365 PLY



BE365 CAM



FE595-PLY-x-FLA



FE285 PLY-x-FLA

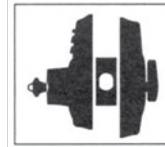

BE365 Keypad Deadbolt

Deadbolt thrown from outside by keyway turn after pressing Schlage button or by inside thumbturn.

Deadbolt retracted from outside by entering valid user code then rotating keyway turn or by inside thumbturn.

Key can be used to unlock as backup



FE285 Lower Half - Front Entry Set

Combine with BE365 Keypad Deadbolt for Front Entry Set.



Security and Quality:

- Grade 2 ANSI/BHMA certified
- Patented commercial grade clutching motor drive ; tested to one million cycles
- Vandal resistant clutching lever and knob design ; free spinning deadbolt turn
- Code control; 6-digit programming code required to add and delete user codes
- Warning code sounds after four incorrect codes entered; keypad disabled for 30 seconds
- Mechanical key override; patent pending

Convenience:

- Convenient keyless access; no keys to hide , lose or forget
- Pre-set with random 6-digit programming code and two random 4-digit user codes
- 19 user code capacity ; 10,000 user code combinations
- Easily programmed right at the keypad; no need to remove inside escutcheon
- Blue LEDs illuminate the keypad on demand
- Reversible levers for left- or right -handed doors
- Emergency exit feature; allows for panic-free exit on and FE595
- Locks can be re-keyed to match existing locks
- 9-volt alkaline battery included

Stocked Product

BE365	Camelot	505,619,716
BE365	Plymouth	505,619,626,716
FE285	Camelot/Accent	505,619,716
FE285	Century/Latitude	619
FE285	Century/Merano	619,716
FE285	Plymouth/Flair	619
FE595	Camelot/Accent	619,716
FE595	Plymouth/Flair	619
FE595	Plymouth/Latitude	619

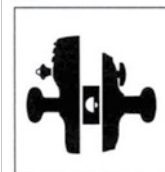

FE595 Keypad Entry with Flex-Lock

Flex Locking, switch between unlocked or automatic re-locking.

Unlocked by valid user code from outside.

Inside lever always unlocked

Key can be used to unlock as back-up

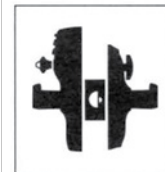

Schlage - FE Electronic Locks BE Touchscreen Deadbolts

BE468 Schlage Connect™

- Uses Z-Wave® Plus or Zigbee to connect to an existing smart home or security system
- ANSI/BHMA A156.36-2010 Commercial Grade 2
- ANSI/BHMA 156.40-2015 Residential Grade BAA



BE468NX

BE469 Schlage Connect™ with Alarm

- Uses Z-Wave® Plus to connect to an existing smart home or security system
- Includes a built-in alarm that detects activity at the door
- ANSI/BHMA A156.36-2010 Commercial Grade 1
- ANSI/BHMA 156.40-2015 Residential Grade AAA
- Auto Lock capability when programmed



BE469NX CAM

BE469NX CEN

FE599 Connected Keypad Lever

- Uses Z-Wave® to connect to an existing smart home or security system
- ANSI A156.36-2003 Grade 2



FE599 CAM x ACC

FINISHES

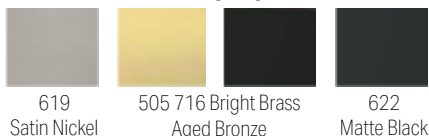

619
Satin Nickel

505 716 Bright Brass
Aged Bronze

622
Matte Black

Stocked Product

BE468NX	Camelot	619, 716
BE469NX	Camelot	619, 622, 716
BE469NX	Century	619, 622, 625, 716
FE599	Camelot x Accent	619

Schlage - FE489 - Smart WiFi Deadbolt With Handleset Encode

Standard Features:

- Built-in WiFi allows you to lock/unlock from anywhere, plus set up guest access codes for recurring, temporary or permanent access when paired with the Schlage Home app or Key by Amazon app, no additional accessories required.
- For additional convenience, enjoy voice commands via Alexa or Google Assistant.
- Create and manage up to 100 access codes for trusted friends and family to use with the fingerprint-resistant, capacitive touchscreen with easy one-touch locking
- Lock and unlock your door from anywhere using compatible home automation systems (Schlage Home, Key by Amazon, Ring, Amazon Alexa, Google Assistant, Yonomi)



Stocked Products

ITEM #	DESCRIPTION	FINISH
FE489WB	Century x Latitude	619
FE489WB	Camelot x Avila	619, 716

Schlage - BE489WB - Smart WiFi Deadbolt

Encode

Standard Features:

- Built-in WiFi allows you to lock/unlock from anywhere, plus set up guest access codes for recurring, temporary or permanent access when paired with the Schlage Home app or Key by Amazon app, no additional accessories required.
- For additional convenience, enjoy voice commands via Alexa or Google Assistant.
- Create and manage up to 100 access codes for trusted friends and family to use with the fingerprint-resistant, capacitive touchscreen with easy one-touch locking
- Lock and unlock your door from anywhere using compatible home automation systems (Schlage Home, Key by Amazon, Ring, Amazon Alexa, Google Assistant, Yonomi)



Camelot 619



Camelot 622



Century 619



Century 622



Century 625



Century 716



Stocked Products

ITEM #	DESCRIPTION	FINISH
BE489WB	Camelot	619, 622
BE489WB	Century	619, 622, 625, 716

Schlage - BE/FE

BE479 Schlage Sense™ Smart Deadbolt

- Share and control access with Schlage Home app for iOS and Android
- Remote access available with Schlage Sense Wi-Fi Adapter
- Works with Apple HomeKit™ technology
- App includes access codes schedules and audit trail capability
- ANSI/BHMA A156.36-2010 Commercial Grade 1
- ANSI/BHMA 156.40-2015 Residential Grade AAA



BE479

Stocked Product

BE479	Camelot	619, 622, 716
BE479	Century	619, 622

BR400 - Schlage Sense™ Wi-Fi Adapter

Features:

- Works with Schlage Sense Smart Deadbolt only
- Lock/unlock from anywhere on Android smartphones, iPhone, iPad, iPod touch *
- Easy pairing with smartphone through Schlage Sense app
- Easy to set up: just plug into power and connect to home Wi-Fi network
- One Adapter can support up to 2 locks
- Comes with the same type of encryption used in many online purchases
- 1-year limited warranty

Specifications:

- Material: Plastic



Stocked Product

BR400 Sense Wi-Fi Adapter

Schlage - *F Locks*

F Functions – ANSI A156.2, Series 4000, Grade 2

- Radius and circular face plates for F10/F40 functions
- Radius, square, and circular face plates for F51, F58 function
- 5 pin solid brass cylinder
- Universal backset either 2-3/8" or 2-3/4"
- 1-3/8" - 1-3/4" thick door



F60

Entrance Lock

Deadbolt thrown or retracted by key from outside or by inside turn unit. Latch retracted by thumbpiece from outside or by inside knob/lever. Consists of: **F58 Outside trim**

F59 Inside trim



F93

Dummy Trim

Outside and Inside Dummy Trim
For use as door pull or as dummy trim on inactive leaf of pair of doors. Fixed thumbpiece and inside knob/lever. Dummy cylinder with inside plate. Consists of:

F92 Outside trim
F94 Inside trim



F10 ANSI F75

Passage Latch

Both knobs/levers always unlocked.



F170

Single Dummy Trim

Dummy trim for one side of door.
Used for door pull or as matching inactive trim.



F40 ANSI F76

Bath/Bedroom Privacy Lock

Push-button locking. Can be opened from outside with small circular tool. Turning inside knob/lever releases button.



F51 ANSI F81

Entrance Lock

Keyed entry function unlocks when door is opened from the inside, allowing you to leave quickly, conveniently and re-enter easily. Locked by inserting key and rotating cylinder from outside, or manually rotating interior turn-button after exit

Schlage - *F Locks*

F Locks - **Handlesets**

F58-OUTSIDE KEYED

F92-OUTSIDE DUMMY TRIM



ADDISON
Symbol **ADD**



CAMELOT
Symbol **CAM**



CENTURY
Symbol **CEN**



GREENWICH
Symbol **GRW**



PLYMOUTH
Symbol **PLY**



WAKEFIELD
Symbol **WKF**

Stocked Product:

F58	Addison	619,621,622,625,716
F58	Camelot	505,605,609,619,620,622,625,716
F58	Century	619,622,625,716
F58	Greenwich	716, 619,622
F58	Plymouth	505,605,609,613,619,620,625,716
F58	Wakefield	619, 716
F92	Camelot	605,609,619,716
F92	Plymouth	505,605,609,619,716

Schlage - F Locks

F Locks - Handlesets Inside Trim

F59 - INSIDE, F94 - DUMMY



ACCENT
Symbol **ACC** (Handed)



LATITUDE
Symbol **LAT**



FLAIR
Symbol **FLA** (Handed)



SIENA
Symbol **SIE**



AVANTI
Symbol **AVA** (Handed)



BROADWAY
Symbol **BRW**



GEORGIAN
Symbol **GEO**



ORBIT
Symbol **ORB**



PLYMOUTH
Symbol **PLY**



MANHATTAN
Symbol **MNH** (Handed)

F Locks - Handlesets Inside Trim with Collection Series Decorative Rose



AVILA x ADDISON
Symbol **VLA x ADD**



LATITUDE x CENTURY
Symbol **LAT x CEN**

Stocked Product:

F59	Accent	605,609,613,619,620,622,625,716
F59	Avanti	619,716
F59	Avila	716
F59	Broadway	622
F59	Flair	605,609,619,620,625,716
F59	Georgian	609,619,716
F59	Latitude	619,622,625
F59	Manhattan	619,625
F59	Orbit	619
F59	Plymouth	605,609,619,620,622,625,716
F59	Siena	619,620,625,716
F94	Accent	605,609,619,620,716
F94	Avanti	619,716
F94	Flair	605,609,716
F94	Georgian	609,619,716
F94	Manhattan	626
F94	Orbit	619
F94	Plymouth	605,619,716
F94	Siena	619

COLLECTION SERIES

F59	Avila x Addison	716
F59	Latitude x Century	619,625

Schlage - *F Locks*

F Locks - Knobs & Levers



BELL
Symbol **BEL**



GEORGIAN
Symbol **GEO**



ORBIT
Symbol **ORB**



PLYMOUTH
Symbol **PLY**



SIENA
Symbol **SIE**



ACCENT
Symbol **ACC**



AVANTI
Symbol **AVA**



BROADWAY
Symbol **BRW**



ELAN
Symbol **ELA**



FLAIR
Symbol **FLA**



JAZZ
Symbol **JAZ**



LATITUDE
Symbol **LAT**



MANHATTAN
Symbol **MNH**



MERANO
Symbol **MER**

Schlage - *F Locks*

Stocked Products

Accent

F170 605,609,613,619,620,622,625,716
 F10 605,609,613,619,620,621,622,625,716
 F40 605,609,613,619,620,621,622,625,716
 F51A 505,605,609,613,619,620,622,625,716

Avanti

F170 619,716
 F10 619,716
 F40 619,716
 F51A 619,716

Bell

F170 626
 F10 605,626
 F40 605,626
 F51A 605,626

Broadway

F170 622
 F10 622
 F40 622
 F51A 622

Elan

F170 605,626
 F10 605,609,625,626
 F40 605,609,625,626
 F51A 505,626

Flair

F170 605,609,619,620,625,626,716
 F10 605,609,619,620,625,626,716
 F40 605,609,619,620,625,626,716
 F51A 505,605,609,619,625,626,716

Georgian

F170 605,609,619,620,716
 F10 605,609,619,620,625,716
 F40 605,609,619,625,716
 F51A 505,605,609,619,620,716

F40 Split Finish x 625

Flair 605
 Plymouth 605

Jazz

F170 626
 F10 626
 F40 619,626

Latitude

F170 619,622,625,716
 F10 619,622,625,716
 F40 619,622,625,716
 F51A 619,622,625,716

Manhattan

F170 619,625,626
 F10 619,625,626
 F40 619,625,626
 F51A 619,626

Merano

F170 619,625,716
 F10 619,625,716
 F40 619,625,716
 F51A 619,716

Orbit

F170 619,626
 F10 619,625,626
 F40 619,625,626
 F51A 619,625,626

Plymouth

F170 505,605,619,622,625,626,716
 F10 505,605,619,620,622,625,626,716
 F40 605,619,622,625,626,716
 F51A 505,605,619,620,622,625,626,716

Siena

F170 609,619,620,716
 F10 609,619,625,716
 F40 609,619,625,716
 F51A 619,620,625,716

Schlage - F Parts

F Lock - Strikes

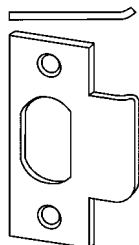

10-001
Square corner
T Strike
1-1/8" x 2-3/4"

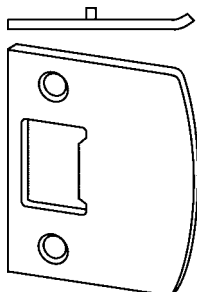

10-026
Square corner
Full lip, no box
1-5/8" x 2-1/4"

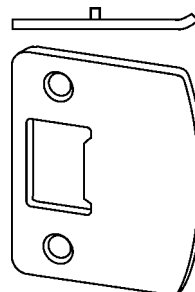

10-027
1/4" radius, round corner
Full lip, no box
1-5/8" x 2-1/4"

F Series - Latches And Parts

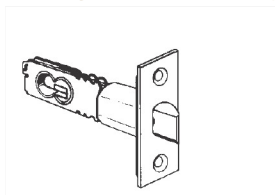

16-200
Spring latch
Square corner
2-3/8" or 2-3/4" BS

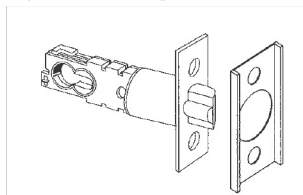

16-207
Dead latch Square corner
2-3/8" or 2-3/4" BS with
A501-878 Front Adapter

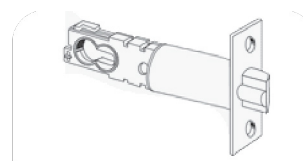

16-126
Dead Latch
Square Corner
5" BS



B520-283 STRIKE
DUST BOX

Stocked Products

10-001	Square Corner Strike, 1-1/8" X 2-3/4" FP	
Finishes	605,613,619,626	
10-026	Square Corner Strike, Full Lip, 1-5/8" X 2-1/4" Face Plate	
Finishes	605,609,613,619,626	
10-027	Round Corner Strike, 1/4" Radius, Full Lip, 1-5/8" X 2-1/4" FP	
Finishes	605,609,613,619,620,626	
16-200	Spring Latch, Square Corner, 2-3/8"-2-3/4" BS,	
16-207	Dead Latch Square Corner, 2-3/8"-2-3/4" BS	
Above Stock Finishes: 605,609,613,619,626		
16-126	Dead Latch, Square Corner, 5" BS	605,619
B520-283	Black Std Dust Box	

Schlage - *F Locks* Collection Series



Champagne x Andover



St. Annes x Andover



Sienna x Andover



Andover x Andover



Accent x Addison



Accent x Camelot



Accent x Wakefield



Avila x Addison



Georgian x Addison



Georgian x Camelot



Latitude x Century



Latitude x Addison



Merano x Century



Manhattan x Century



Siena x Wakefield



Georgian x Brookshire

Schlage - *F* Locks Collection Series

Stocked Products

Andover Rose (concealed screw)

F170 Andover	619,716
F10 Andover	619,716
F40 Andover	619,716
F51A Andover	619,716
F170 Champagne	619,716
F10 Champagne	619,716
F40 Champagne	619,716
F51A Champagne	619,716
F170 Sienna	625
F10 Sienna	622
F40 Sienna	619,622
F10 ST Annes	716
F40 ST Annes	716

Addison Rose

F170 Accent	619
F10 Accent	619
F40 Accent	619
F51A Accent	619
F170 Avila	619,716
F10 Avila	619,625,716
F40 Avila	619,716
F51A Avila	619,716
F170 Georgian	619
F10 Georgian	619
F40 Georgian	619
F51A Georgian	619
F170 Latitude	625

Camelot Rose

F170 Accent	619,716
F10 Accent	619,716
F40 Accent	619,716
F51A Accent	619,716
F10 Georgian	619

Century Rose

F170 Latitude	619, 625
F10 Latitude	619, 625
F40 Latitude	619, 625
F51A Latitude	619, 625
F170 Manhattan	619
F10 Manhattan	619
F40 Manhattan	619
F51A Manhattan	619
F170 Merano	716
F10 Merano	716
F40 Merano	716

Brookshire Rose F170

Georgian 609 F40
Georgian 609

Wakefield Rose

F170 Accent	619,716
F10 Accent	619,716
F40 Accent	619,622,716
F10 Sienna	619,716
F40 Sienna	619,716

Reversible Levers



Remove inside lever with release pin.



Insert key into outside lever - rotate 90°. Remove with release pin.



Rotate key back, remove key and cylinder. Reverse levers. Place cylinder in other lever.



Snap-on outside lever. Rotate key back and remove.



Snap-on inside lever.

Schlage - FC Locks

FC Locks - Handlesets



Century x Latitude x Collins 619

Century x Latitude x Collins 622



Century x Swanson x Collins 619

Century x Swanson x Collins 622

Stocked Products

FC60 Century x Latitude x Collins 619, 622
FC60 Century x Swanson x Collins 619, 622

Schlage - FC Locks



Latitude x Collins 619



Latitude x Collins 622



Swanson x Collins 619



Swanson x Collins 622



Combined Passage Privacy



Latitude x Collins 619



Latitude x Collins 622



Swanson x Collins 619



Swanson x Collins 622



Entrance



Latitude x Collins 619



Latitude x Collins 622



Swanson x Collins 619



Swanson x Collins 622



Non-Turning Set (sold as a set, dummy function)

Stocked Products

FC21	Latitude x Collins	619, 622
FC51	Latitude x Collins	619, 622
FC172	Latitude x Collins	619, 622
FC21	Swanson x Collins	619, 622
FC51	Swanson x Collins	619, 622
FC172	Swanson x Collins	619, 622

Schlage - CS210 Locks

CS210PD Locks

Standard Features:

- Certification: ANSI/BHMA Certified A156.12-2005, Grade 2, UL listed for 3-hour fire door
- Deadbolt: 1 X 2-1/4", dual option faceplate, (square corner standard, round corner included in package), 1" housing diameter, 1" throw
- Latch 1" x 2-1/4" dual option faceplate (square corner standard, round corner included in package). 1" edge bore required
- Strikes: 1-1/8" X 2-3/4", Square corner (deadbolt) and 1-5/8" X 2-1/4", Square corner, full lip (deadlatch)
- Backset: Adjustable backset, fits 2-3/8" or 2-3/4"
- Cylinders: 6-pin upper cylinder, solid brass, keyed 6-pin, C123 keyway, keyed different (KD)
- Door Range: 1-3/4" to 2"
- Keys: Nickel silver cut keys, 6-pin, C123 section
- Center to Center: **Fits 4" or 5-1/2" center to center door preps ***
** 5-1/2" center-to-center default set-up from factory*



CS210PD F95

Entrance, Single Locking Deadbolt operated by key from outside or by turn unit from inside. Bolt automatically deadlocks when fully thrown. Latch retracted by lever from either side. Turning inside lever retracts deadbolt and latch simultaneously for immediate exit.

Stocked Product:

Design
Camelot x Saturn

Finishes
626, 643e

Schlage - S200 Locks

S 200 Locks – ANSI A156.12, 1992, Grade 2

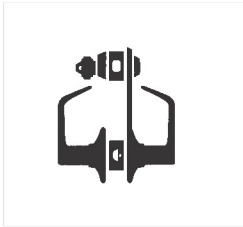

S210D ANSI F95

Entrance, Single Locking Deadbolt operated by key from outside or by turn unit from inside. Bolt automatically deadlocks when fully thrown. Latch retracted by lever from either side. Turning inside lever retracts deadbolt and latch simultaneously for immediate exit.

S251PD ANSI F97

Entrance, Double Locking Deadbolt operated by key from outside or by turn unit from inside. Bolt automatically deadlocks when fully thrown. Outside lever unlocked by key from outside when locked by turn button in inside lever. Turning inside lever retracts deadbolt and latch simultaneously for immediate exit. Latch automatically deadlocks when door is closed.

S251 NEP



S251 SAT



Standard Features:

- All S200 stocked standard.
- 2-3/4" backset, optional 2-3/8" backset available.
- UL Listed for 3 hour fire door.
- Strike 1-1/8" x 2-1/4" square corner faceplate/T Strike
- Door Range 1-3/8" - 2" thickness
- Keyway Classic "C", Everest available upon request
- Center to Center 4" CTC

Standard Deadlatch 16-228 2-3/8" or 2-3/4" BS

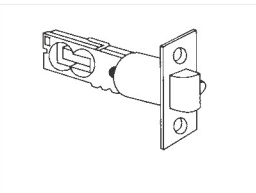

S251 SAT INTERIOR



Stocked Parts 626 finish

16-228 Dead Latch, Square Corner, 2-3/8"-2-3/4"BS,
1-1/8" X 2-1/4" Face Plate, 1" hsg

Stocked Product

FUNCTION	DESIGN	FINISHES
S210	Neptune	626
	Saturn	613,626
S251	Neptune	626
	Saturn	613,626

Schlage - B250 Deadlatch Locks

B250 Series



B250PD Single Cylinder Deadlatch

- Deadlatch retracted by key outside or thumbturn inside
- Holdback feature standard
- Rotating thumbturn and activating holdback feature keeps latch retracted



B252PD Double Cylinder Deadlatch

- Deadlatch retracted by key either side
- No holdback

Specifications:

- Door thickness: 1-3/8" to 1-3/4" standard.
- Door preparation: 1-1/2" bore
- Backset: Standard: 2-3/8" Optional: 2-3/4"
- Faceplate: 1-1/8" x 2-1/4" square corner, beveled.
- Bolt: Brass, 9/16" throw, deadlocking on keyed and exterior functions.
- Strike: T strike 10-001 1-1/8" x 2-3/4" with steel reinforcer and two 3" screws standard.
- C Keyway

Stocked Product

B250P	605,613,626
B252P	613,626
B520-086 Mounting Screw 2-1/4" 605	
B520-271 Drive Pin only	626

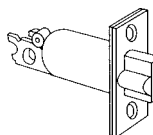
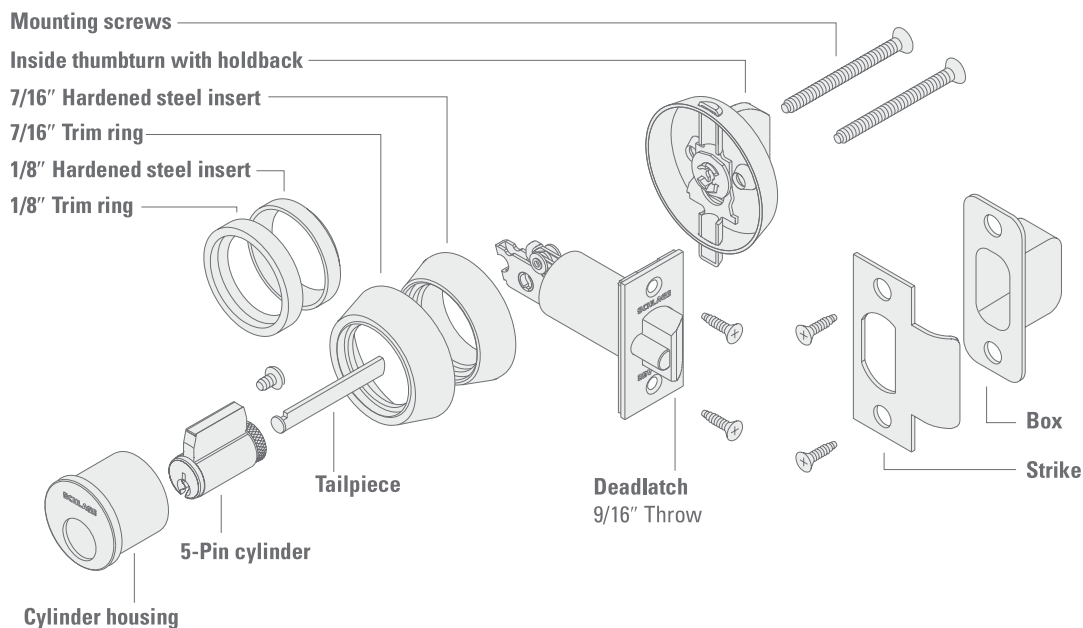

12-100
2-3/8" BS square corner 1-1/8" x 2-1/4"

12-103
2-3/4" BS square corner 1-1/8" x 2-1/4"

Stocked Product

12-100	605,613,626
12-103	605,613,626

Schlage - B500 Deadbolts

B500 Series - Deadbolt

Certifications: ANSI A156.5, 2001, Grade 2. Available UL Listed for three-hour fire door.

Door range: 1-3/8" to 1-3/4" thick (35 mm to 44 mm) standard. Available for over 1-3/4" to 2-1/4" and over 2-1/4" to 4" assembled to order. **Special Order.**

Backset: 2-3/8" (60 mm) or 2-3/4" (70 mm) adjustable backset standard.

Deadbolts: 1" x 2-1/4" (25 mm x 57 mm) square corner.

Strikes: Square corner 1-1/8" x 2-3/4" (29 mm x 70 mm) strike, no lip, furnished with metal dust box standard.

Adapter Rings: Trim ring with anti-pry shield standard, 2-1/2" (63 mm) outer diameter. Removable to fit 1-1/2" crossbore door preps.



Functions:

ANSI A156.5, 2001, Grade 2

Bored Deadbolt Locks

SCHLAGE ANSI

B560P E2152



Single Cylinder Deadbolt Lock Deadbolt thrown or retracted by key from outside or by inside turn unit. Bolt automatically deadlocks when fully thrown.

B562P E2142



Double Cylinder Deadbolt Lock* Deadbolt thrown or retracted by key from either side. Bolt automatically deadlocks when fully thrown.

B580 E2192



Door Bolt Deadbolt thrown or retracted by turn unit only. No outside trim. Bolt automatically deadlocks when fully thrown.

B571



Door Occupancy Indicator Deadbolt thrown or retracted by inside turn unit. Occupancy indicator on outside (reads either in use or vacant. Requires 1-1/2" cross bore prep. Not UL rated.

Specifications:

Door Preparation

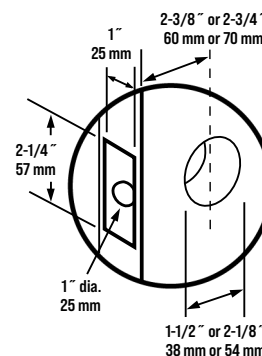

Stocked Product

B560P 605, 609, 613, 619, 625, 626

B562P 605, 609, 613, 625, 626

B571 613, 626

B580 605, 609, 613, 625, 626

B 500 Series - Strikes, Bolts and Accessories

Stocked Product

10-064 Thimble Strike 626

10-094 Square Corner Strike 1-1/8" X 2-3/4" 605,609,613, 619,620,625,626

38-031 GOOF Ring, 2-1/2" Diameter for 2-1/8" Door prep 605,609,613,625,626

A501-565 Reinforcer for 1-3/8" Thick Metal Doors no finish



10-064



38-031
GOOF RING

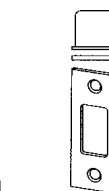

10-094
STANDARD

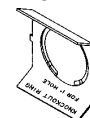

A501-566
A501-565

Schlage - B600 Deadbolts

B600 Series - Deadbolt

Features:

Certification ANSI A156.5 Grade 1, UL Listed for 3 hour door
 Deadbolt 1-1/8" x 2-1/4" square corner faceplate, 1" housing 1" throw
 Backset Standard 2-3/4", also available 2-3/8"
 Cylinder Standard classic "C" also available C123 Everest



Options:

- Available prepped for Removable Core (RC) less core; specify "J"
- Available prepped F/ Best IC Core (Small Format) less core specify "B"

For Everest keyway specify suffix EV after part number i.e. 9SCHB660P605EV
 Door preparation 1-1/2" or 2-1/8" bore size

Stocked Product:

- B660P** 605,613,625,626
- B660B** 626
- B660J** 613,626
- B661P** 626
- B662P** 605,613,626
- B662J** 626
- B663P** 626
- B663J** 613,626
- B664P** 626



B660P ANSI E2151 Single Cylinder Deadbolt Lock

Deadbolt thrown or retracted by key from outside or by inside turn unit. Bolt automatically deadlocks when fully thrown.



B661P ANSI E2161 One-way Deadbolt Lock

Deadbolt thrown or retracted by key only. Blank plate inside. Bolt automatically deadlocks when fully thrown.



B662P ANSI E2141 Double Cylinder Deadbolt Lock

Deadbolt thrown or retracted by key from either side. Bolt automatically deadlocks when fully thrown.



B663P ANSI E2111 Classroom Deadbolt Lock

Deadbolt thrown or retracted by key outside. Inside turn unit will retract bolt only. Bolt automatically deadlocks when fully thrown.



B664P ANSI E2101 Cylinder Lock

Deadbolt thrown or retracted by key from one side. No inside trim. Bolt automatically deadlocks when fully thrown.

B660 Parts

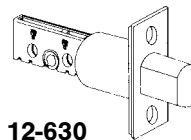

12-630

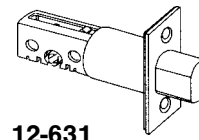

12-631

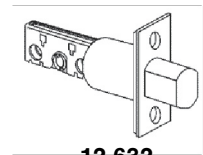

12-632



10-087

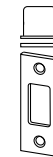

10-055

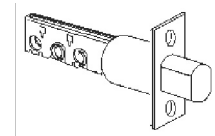

12-633

Stocked Product:

10-055	Square Corner Strike, 1-1/8" X 2-3/4" FP	605,613,626
10-087	ANSI Strike With 1-3/16" Lip	605,613,619, 620,625,626
12-630	Bolt, 2-3/8" BS, 1-1/8" X 2-1/4" Face Plate	605,613,626
12-631	Bolt, 2-3/4" BS, 1-1/8" X 2-1/4" Face Plate	605,613,626
12-632	Bolt, 3-3/4" BS, 1-1/8" X 2-1/4" Face Plate	626
12-633	Bolt, 5" BS, 1-1/8" X 2-1/4" Face Plate	613,626

Schlage - A Series

Light Commercial A Functions

ANSI A156.2, Series 4000, Grade

2

- 6 pin cylinder, keyed 5 pin C keyway
- 2-3/8" backset with 10-001 T-strike
- Optional strikes & backsets available
- 1-3/8" - 1-7/8" thick door



A10S ANSI F75

Passage Latch

Both knobs always unlocked.



A40S ANSI F76

Bath/Bedroom Privacy Lock

Push-button locking. Can be opened from outside with small screwdriver. Turning inside knob or closing door releases button.



A53PD ANSI F109

Entrance Lock

Turn/push-button locking; pushing and turning button locks outside knob, requiring use of key until button is manually unlocked. Push-button locking; pushing button locks outside knob until unlocked by key or by turning inside knob.



A70PD ANSI F109

Classroom Lock

Outside knob locked and unlocked by key. Inside knob always unlocked.



A80PD ANSI F86

Storeroom Lock

Outside knob fixed. Entrance by key only. Inside knob always unlocked.



A170

Single Dummy Trim

Dummy trim for one side of door. Used for door pull or as matching inactive trim.

Standard 2-3/8" BS, T strike with classic "C" keyway. Optional latches and strikes available

LEVON Symbol **LEV**

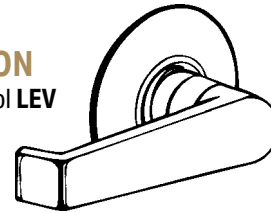

ORBIT Symbol **ORB**

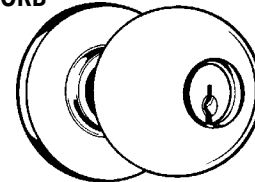

PLYMOUTH Symbol **PLY**

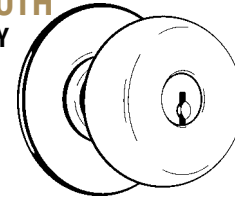

Stocked Product

Style	Function	Finish
Levon	A10S Passage	613,626
	A40S Privacy	613,626
Orbit	A10S Passage	613,625,626
	A170 Dummy	605,613,625,626
	A40S Privacy	605,613,625,626
	A53P Entry	605,613,625,626
	A70P Classroom	605,613,626
	A80P Storeroom	613,625,626
Plymouth	A10S Passage	605,613,626
	A170 Dummy	605,613,626
	A40S Privacy	605,613,626
	A53P Entry	605,613,626
	A70P Classroom	613,626
	A80P Storeroom	605,613,626

Schlage - A Parts

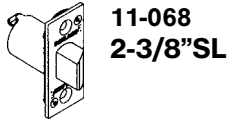

11-068
2-3/8"SL

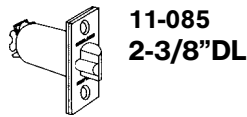

11-085
2-3/8"DL



A Series
Screws
A501-161

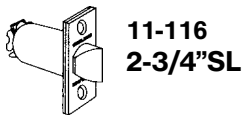

11-116
2-3/4"SL

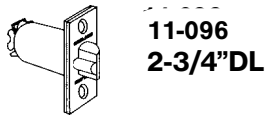

11-096
2-3/4"DL



11-104
2-3/8"
CIRCULAR
DRIVE-IN DL

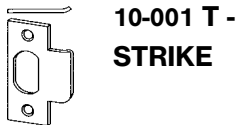

10-001 T -
STRIKE

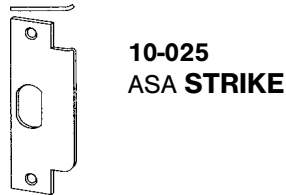

10-025
ASA STRIKE



10-026
SQUARE CORNER
FULL LIP STRIKE



10-027
RADIUS CORNER
FULL LIP STRIKE



A501-878
FACEPLATE
ADAPTER

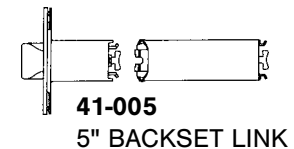

41-005
5" BACKSET LINK

Stocked Product

11-068 Spring Latch 2-3/8" BS, 1" X 2-1/4" Face, 7/8" hsg	605,613,626
11-116 Spring Latch 2-3/4"BS, 1-1/8" X 2-1/4" Face 1" hsg	605,613,626
11-085 Dead Latch 2-3/8" BS, 1"X 2-1/4" Face 7/8" hsg	605,613,626
11-096 Dead Latch 2-3/4" BS, 1-1/8" X 2-1/4" Face 1" hsg	605,613,626
11-091 Dead Latch 2-3/4" BS, 1" X 2-1/4" Face 7/8" hsg	605,613,626
11-103 Dead Latch 3-3/4" BS, 1-1/8" X2-1/4: Face 1" hsg	626
11-104 Dead Latch, Circular, 2-3/8" BS. 1" hsg	626
11-105 Dead Latch, Circular, 2-3/4" BS. 1" hsg	626
10-001 T Strike, 1-1/8" X 2-3/4" Square Corner	605,613,619,626
10-025 ANSI no box, 1-1/4" X 4-7/8" Square Corner	605,613,626,619,625
10-025 ANSI no box, 1-1/2" X 4-7/8" Square Corner	613,625,626
10-026 SQ Strike, Full Lip 1-5/8" X 2-1/4"	605,613,626,619,620,609
10-027 Radius Strike, Full Lip 1-5/8" X 2-1/4"	605,613,626,619,620,609
41-005 5" Backset Link	-

Schlage - AL Series

DISCONTINUED CALL FOR AVAILABILITY



AL10S ANSI F75

Passage Latch Both levers always unlocked.



AL25D

Exit Lock

Blank plate outside. Inside lever always unlocked.



AL40S ANSI F76

Bath/Bedroom Privacy Lock

Push-button locking. Can be unlocked from outside with small screwdriver. Turning inside lever or closing door released button.



AL170

Simple Dummy Trim

Dummy trim for one side of door. Used for door pull or as matching inactive trim.



AL50PD ANSI F82

Entrance/Office Lock

Push-button locking. Push-button locks outside lever until unlocked with key or by rotating inside lever.



AL53PD ANSI F109

Entrance Lock

Turn/push-button locking; pushing and turning button locks outside lever requiring use of key until button is manually unlocked. Push-button locking; pushing button locks outside lever until unlocked by key or by turning inside lever.



AL70PD ANSI F84

Classroom Lock

Outside lever locked and unlocked by key. Inside lever always unlocked.



AL80PD ANSI F86

Storeroom Lock

Outside lever fixed. Entrance by key only. Inside lever always unlocked.

Standard Features:

Certification	ANSI A156.2, 1996, Series 4000, Grade 2, UL Listed for 3 hour fire door
Latch	1-1/8" x 2-1/4", Square corner faceplate, 1" housing diameter, 1/2" throw
Strike	1-1/4" x 4-7/8" ANSI, Square corner, no box
Backset	Standard 2-3/4", optional 2-3/8" BS available
Door Range	1-3/8" - 1-7/8"
Keyed locks	6 pin cylinder, keyed 5 pin C keyway, KD -also available Everest C123

Stocked Product

Stocked Functions: AL10S, AL170, AL40S, AL50P, AL53P, AL70P, AL80P
 Stocked Finishes: 605, 613, 625, 626
 Stocked Designs: Saturn and Neptune

Stocked Functions: AL25D,
 Stocked Finishes: 626
 Stocked Designs Saturn, Neptune

Stocked Function: AL50J, AL53J, AL70J, AL80J, Large format interchangeable Core, Less Core
 Stocked Finishes: 626
 Stocked Designs: Saturn

Stocked Function: AL50J, AL53J, AL70J, AL80J, Large format interchangeable Core, Less Core
 Stocked Finishes: 626
 Stocked Designs: Neptune

Stocked Function: AL53BSAT, Small format interchangeable Core, Less Core
 Stocked Finishes: 626
 Stocked Designs: Saturn

Stocked Function: AL80BSAT, Small format interchangeable Core, Less Core
 Stocked Finishes: 626
 Stocked Designs: Saturn

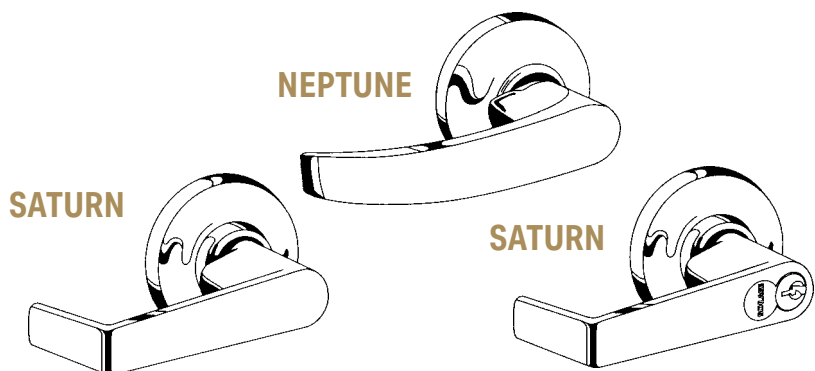

Schlage - AL Parts

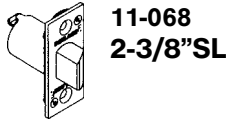

11-068
2-3/8"SL

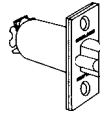

11-085
2-3/8"DL

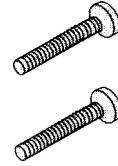

A Series
Screws
A501-161

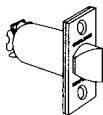

11-116
2-3/4"SL

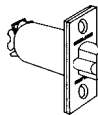

11-096
2-3/4"DL



11-104
2-3/8"
CIRCULAR
DRIVE-IN DL

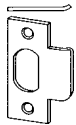

10-001 T -
STRIKE



10-025
ASA STRIKE



10-026
SQUARE CORNER
FULL LIP STRIKE

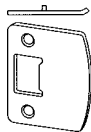

10-027
RADIUS CORNER
FULL LIP STRIKE



A501-878
ADAPTER

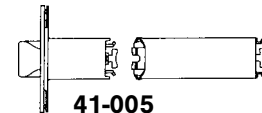

41-005
5" BACKSET LINK

Stocked Product

11-068 Spring Latch 2-3/8" BS, 1" X 2-1/4" Face, 7/8" hsg	605,613,626
11-116 Spring Latch 2-3/4"BS, 1-1/8" X 2-1/4" Face 1" hsg	605,613,626
11-085 Dead Latch 2-3/8" BS, 1"X 2-1/4" Face 7/8" hsg	605,613,626
11-096 Dead Latch 2-3/4" BS, 1-1/8" X 2-1/4" Face 1" hsg	605,613,626
11-091 Dead Latch 2-3/4" BS, 1" X 2-1/4" Face 7/8" hsg	605,613,626
11-103 Dead Latch 3-3/4" BS, 1-1/8" X2-1/4: Face 1" hsg	626
11-104 Dead Latch, Circular, 2-3/8" BS. 1" hsg	626
11-105 Dead Latch, Circular, 2-3/4" BS. 1" hsg	626
10-001 T Strike, 1-1/8" X 2-3/4" Square Corner	605,613,619,626
10-025 ANSI no box, 1-1/4" X 4-7/8" Square Corner	605,613,626,619,625
10-025 ANSI no box, 1-1/2" X 4-7/8" Square Corner	613,625,626
10-026 SQ Strike, Full Lip 1-5/8" X 2-1/4"	605,613,626,619,620,609
10-027 Radius Strike, Full Lip 1-5/8" X 2-1/4"	605,613,626,619,620,609
41-005 5" Backset Link	-

Schlage - ALX Series

ALX Series - Levers



ALX10 ANSI F75

Passage Latch

No key; plain lever both sides; spring latch
Both levers always unlocked

ALX40 ANSI F76

Bath/Bedroom Privacy Lock



No key; emergency access coin turn outside; push button inside; spring latch
Inside push button locks outside lever
Turn inside lever or close door to release button and prevent lock-out; outside coin turn provides emergency access
Field selectable Vandlgard® feature
Inside lever is always free for immediate egress

ALX170

Single Dummy Trim



No key; rigid plain lever outside; no hardware inside; no latchbolt
Use as door pull or matching inactive trim

ALX50 ANSI F82

Entrance/Office Lock



Key cylinder outside; push button inside; deadlatch
Inside push button locks outside lever
Unlock with key outside or by rotating inside lever
Field selectable Vandlgard® feature
Inside lever always free for immediate egress

ALX53 ANSI F109

Entrance Lock



Key cylinder outside; push/turn button inside; deadlatch
Inside button locks outside lever by pushing button or pushing and turning button
Pushed button: unlock with key outside or by rotating inside lever
Pushed/turned button: key outside retracts latch only; unlock by returning inside button to home position then using key or rotating inside lever
Field selectable Vandlgard® feature
Inside lever always free for immediate egress

Standard Features:

Certification	ANSI/BHMA Certified A156.2-2011, Series 4000, Grade 2, UL Listed for 3-hour fire door
Latch	1-1/8" x 2-1/4" Square corner faceplate, 7/8" housing diameter with 1" diameter sleeve, 1/2" throw
Strike	1-1/4" x 4-7/8" ANSI, square corner, no dust box
Backset	2-3/4"
Cylinder	6-pin solid brass, keyed 5-pin, C keyway, keyed different (KD)
Door Range	1-3/8" through 1-3/4"

Options:

Available prepped for Removable Core (RC) less core; specify "J"
Available prepped F/Best IC Core (Small Format) less core specify "B"

Athens



Rhodes



Saturn



Sparta



ALX70 ANSI F84

Classroom Lock



Key cylinder outside; plain lever inside; deadlatch
Key in outside lever locks or unlocks outside lever
Field selectable Vandlgard® feature Inside lever always free for immediate egress

ALX80 ANSI F86

Storeroom Lock



Key cylinder outside; plain lever inside; deadlatch
Outside lever always fixed
Key can retract the latch
Field selectable Vandlgard® feature
Inside lever always free for immediate egress

Schlage - ALX Series

ALX Series - Parts

Stocked Product

Style	Function	Finish
Athens	10	625, 626
	40, 53, 80	626
	53	626
	80	626
Rhodes		
B-Prep Option	53, 80	626
Rhodes		
J-Prep Option	50, 53, 70, 80	626
Saturn	170	613, 626
	10	613, 625, 626
	40, 50, 53, 80	613, 626
	70	626
Sparta	170	626
	10, 40, 80	613, 626
	53	613, 625, 626
	50, 70	626
Sparta J-Prep Option	50, 80	626

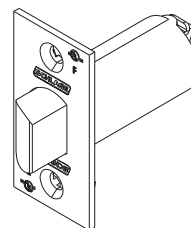

47273614 2-3/4" SL
47273620 2-3/8" SL

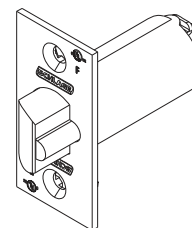

47273617 2-3/4" DL
47273623 2-3/4" DL

Stocked Product

Latches

47273614	Spring latch 2-3/4" BS, 1-1/8" x 2-1/4" Face	613, 626
47273620	Spring latch 2-3/8" BS, 1-1/8" x 2-1/4" Face	613, 626
47273617	Dead latch 2-3/4" BS, 1-1/8" x 2-1/4" Face	613, 626
47273623	Dead latch 2-3/8" BS, 1-1/8" x 2-1/4" Face	613, 626
43-005	5" BS extension (use with 2-3/4" latches only)	

Strikes

10-013	T-strike, 1-1/8" x 2-3/4"	613, 625, 626
10-025	ASA strike, 1-1/4" x 4-7/8"	613, 625, 626
10-025-112	ASA strike, 1-1/2" x 4-7/8"	613, 625, 626
K510-066	ASA Plastic strike box 1-7/32 x 4-13/16	N/A

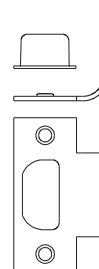

10-013
T-STRIKE

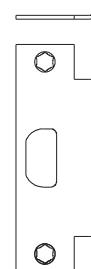

10-013
ASA STRIKE

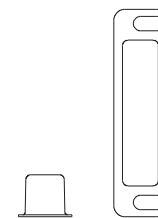

K510-066
ASA STRIKE BOX

Schlage - ND Locks

ND Series - Levers

Standard Features:

Certification	Exceeds ANSI A156.2, Series 4000, Grade 1, UL Listed for 3 hour fire door. Meets A117.1
Feature Latch	Tested to exceed three million cycles 1-1/8" x 2-1/4", Square corner faceplate, 1" housing diameter, 1/2" throw
Strike	1-1/4" x 4-7/8", ANSI, Square corner, no box
Backset	2-3/4" standard, other backsets available
Cylinder	6 pin cylinder, keyed 5 pin C keyway, KD -also available Everest C123

Door Range 1-5/8" - 2-1/8"

Options:

- Available prepped for Removable Core (RC) less core; specify "J"
- Available prepped F/ Best IC Core (Small Format) less core specify "B"

OMEGA



RHODES



SPARTA



TUBULAR



ND10S ANSI F75

Passage Latch

Both levers always unlocked. Inside lever is always free for immediate egress.



ND170

Single Dummy Trim

Dummy trim for one side of door. Used for door pull or as matching inactive trim.



ND25

Exit Lock

Blank plate outside, Inside lever always unlocked. Inside lever is always free for immediate egress.



ND40S ANSI F76

Bath/Bedroom Privacy Lock

Push-button locking. Can be opened from outside with small screwdriver. Turning inside lever or closing door releases button. Inside lever is always free for immediate egress.



ND50PD ANSI F82

Entrance/Office Lock

Push-button locking. Push-button locks outside lever until unlocked with key or by turning inside lever. Inside lever is always free for immediate egress.



ND53PD ANSI F109

Entrance Lock

Turn/push-button locking; pushing and turning button locks outside lever, requiring use of key until button is manually unlocked. Push-button locking; pushing button locks outside lever until unlocked by key or by turning inside lever. Inside lever is always free for immediate egress.



ND60PD ANSI F88

Vestibule/Classroom Security Lock

Latch retracted by key from outside when outside lever is locked by key in inside lever. Inside lever is always unlocked. Inside lever is always free for immediate egress.



ND66PD ANSI F91

Store Lock

Key in either lever locks or unlocks both levers.



ND70PD ANSI F84

Classroom Lock

Outside lever locked and unlocked by key. Inside lever always unlocked. Inside lever is always free for immediate egress.

Schlage - ND Locks



ND73PD ANSI F90

Corridor Lock

Locked or unlocked by key from outside. Push button locking from inside. Turning inside lever or closing door releases button. When outside lever is locked by key it can only be unlocked by key. Inside lever is always unlocked. Inside lever is always free for immediate egress.



ND75PD ANSI F110

Classroom Security Lock

Key in either lever locks or unlocks outside lever. Inside lever is always unlocked. Inside lever is always free for immediate egress.



ND80PD ANSI F86

Storeroom Lock

Outside lever fixed. Entrance by key only. Inside lever always unlocked. Inside lever is always free for immediate egress.



ND80PDEL

Electrically Locked (Fail Safe)

Outside lever continuously locked electrically. Unlocked by key outside or by switch or power failure. Auxiliary latch deadlocks latchbolt when door is closed. Inside lever always free for immediate exit. Inside lever is always free for immediate egress.



ND80PDEU

Electrically Unlocked (Fail Secure)

Outside lever continuously locked until unlocked by key or electric current. Auxiliary latch deadlocks latchbolt when door is closed. Inside lever always free for immediate exit. Inside lever is always free for immediate egress.



ND82PD ANSI F87

Institution Lock

Both levers fixed. Entrance by key in either lever.



ND85PD

Faculti Restroom Lock

Outside lever fixed. Entrance by key only. Pushbutton in inside lever activates visual "occupancy" indicator, allowing only emergency master key to operate. Turning inside lever or closing door releases visual occupancy indicator. Rotation of inside spinner-button provides lock-out feature by keeping indicator thrown. Inside lever is always free for immediate egress.



ND91PD ANSI F82

Entrance/Office Lock

Push-button locking. Push-button disengages outside lever until unlocked with key or by turning inside lever.



ND92PD ANSI F109

Entrance Lock

Turn/push-button locking; pushing and turning button disengages outside lever, requiring use of key until button is manually unlocked. Push-button locking; pushing button disengages outside lever until unlocked by key or by turning inside lever.



ND93PD ANSI F88

Vestibule Lock

Latch retracted by key from outside when outside lever is disengaged by key in inside lever. Inside lever is always unlocked.



ND94PD ANSI F84

Classroom Lock

Outside lever disengaged and unlocked by key. Inside lever always unlocked.



ND95PD ANSI F110

Classroom Security Lock

Key in either lever locks or unlocks outside lever. Inside lever is always unlocked.



ND96DP ANSI F86

Store Room

Outside lever always disengaged. Entrance by key only. Inside lever always unlocked.

Schlage - ND Locks

ND Series Latches & Parts

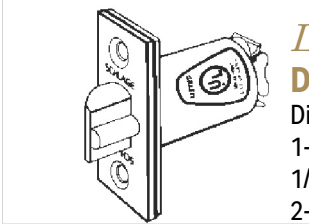

LATCH 13-047
Dead Latch
 Dimension:
 1-1/8" x 2-1/4" square corner
 1/2" throw
 2-3/4 Backset

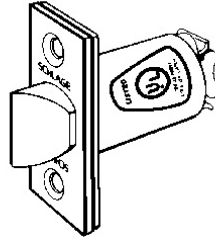

LATCH 13-048
Spring Latch
 Dimension:
 1-1/8" x 2-1/4" square corner
 1/2" throw
 2-3/4 Backset

ND SERIES PARTS

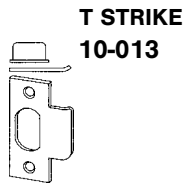

T STRIKE
10-013

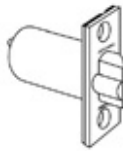

14-028 3-3/4"
 Square Corner
 Deadlatch

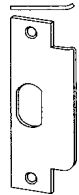

10-025
 ANSI Strike

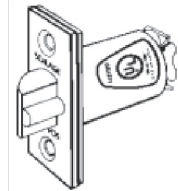

14-047
LATCH
 2-3/8DL

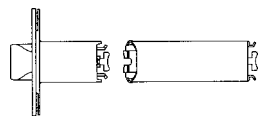

4 Link



K510-066
 Dust Box

Stocked Product:

10-013	605,613,625,626
10-025	605,613,619,625,626
43-005	N/A
13-047	605,613,625,626
13-048	605,613,625,626
14-028	613,626
14-047	605,613,625,626
K510-066	N/A
14-001	605,613,626

Schlage - ND Locks

Stocked Product

STYLE	FN	FINISH
Rhodes	170	613,625,626
	10	605,613,619,622,625,626
	25	626
	40	605,613,619, 622,625,626
	50	605,613,619, 622,625,626
	53	605,613, 622,625,626
	60	626
	66	626
	70	605,613, 622,625,626
	73	626
	75	626
	80	605,613,619, 622,625,626
	82	613,626
	85	626
	91	626
	92	626
	93	613,626
	94	613,626
	95	626
	96	613,626

STYLE	FN	FINISH
Sparta	170	613,619,625,626
	10	605,613,619,625,626
	40	605,613,619,625,626
	50	605,613,619,625,626
	53	605,613,619,625,626
	60	626
	66	626
	70	613,619,625,626
	80	605,613,619,625,626
	85	626
	92	626
	93	626
	94	626
	96	626

STYLE	FN	FINISH
Omega	170	613,626
	10	613,619,626
	40	613,626
	50	613,619,626
	53	605,613,626
	66	626
	70	613,626
	80	613,626

STYLE	FN	FINISH
Tubular	170	626
	10	626
	40	626
	50	626
	53	626
	70	626
	80	626

Less Cylinder		
STYLE	FN	FINISH
Rhodes	53	613,626
	80	613,626
Sparta	53	626
	80	613,626

"J" PREP OPTION		
STYLE	FN	FINISH
Rhodes	50	613,626
	53	613,622,626
	70	613,626
	75	626
	80	613,626
	91	626
	92	626
	94	626
	95	626
	96	626
Sparta	50	613,626
	53	613,626
	70	613,626
	75	626
	80	613,626
	92	626
	94	626
	95	626
	96	626

"B" PREP OPTION		
STYLE	FN	FINISH
Rhodes	50	613,626
	53	613,626
	70	613,626
	80	613,622,626
	91	613,626
	92	613,626
	94	626
	96	626
Sparta	80	613,626

Electrified		
STYLE	FN	FINISH
EL		
Rhodes	80	626
Sparta	80	626
EU		
Rhodes	80	613,626
Sparta	80	613,626
"J" PREP EU		
Rhodes	80	613,626
Sparta	80	613,626
"B" PREP EU		
Rhodes	80	613,626
Sparta	80	613,626

Schlage - NDE Locks

NDE Series - Wireless Lock

Standard Features:

Certification ANSI ANSI/BHMA A156.25-2013, A156.2-2011, Series 4000, Grade 1, UL 294, UL 10C

Latch 1-1/8" x 2-1/4", Square corner faceplate, 1" housing diameter, 1/2" throw

Strike 1-1/4" x 4-7/8", ANSI, Square corner, with DPS magnets, no box

Backset 2-3/4"

Cylinder Classic C keyway

Door Range 1-5/8" - 2"

Users Up to 5,000

Audits Up to 2,000

NDE Series wireless locks utilize the standard ND cylindrical door prep

Options:

- Available prepped for Removable Core (RC) less core; specify "J"
- Available prepped for Best IC Core (Small Format) less core specify "B"



Sparta



Rhodes



NDE80PD F86 Storeroom Lock with Vandlgard Lockset is normally secure with outside lever disengaged. Valid credential or key momentarily unlocks door. Valid credential may be used to change to a passage or secured state. Inside lever always allows free egress.



7410



7610

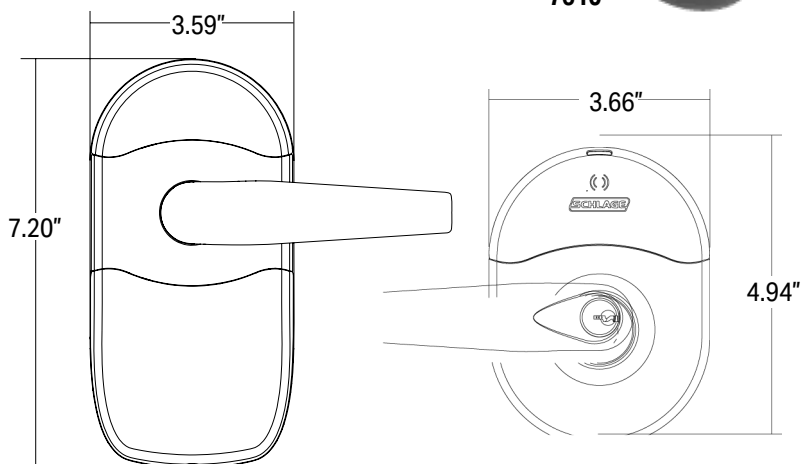

Stocked Product

NDE 80P	Rho/Spa	622, 626, 643E
NDE 80J	Rho/Spa	622, 626, 643E
NDE 80B	Rho	622, 626
7410	Proximity Cards	
7610	Proximity Key Fob	

Schlage - S Locks

S Locks – A156.2 Series 4000 Grade 2

Standard Features:

Certification ANSI A156.2, Series 4000, Grade 2
 Latch 1" x 2-1/4", Square corner
 Strike ANSI strike 10-025
 Backset Adjustable 2-3/8" or 2-3/4"
 Door Range 1-3/8" - 1-7/8" thickness
 Keyway Classic "C", Everest available upon request

SATURN - SAT

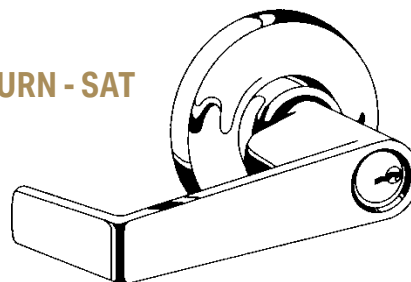

NEPTUNE - NEP

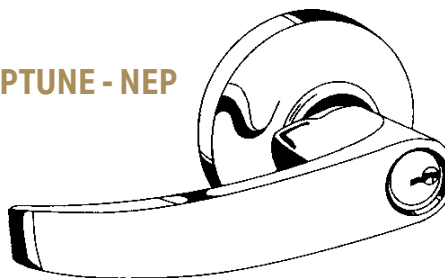

S10S ANSI F75
 Passage Latch
 Both levers always unlocked.



S40S ANSI F76
 Bath/Bedroom Privacy Lock
 Push-button locking. Can be opened from outside with small screwdriver. Turning inside lever or closing door releases button.



S80PD ANSI F86
 Storeroom Lock
 Outside lever fixed. Entrance by key only. Inside lever always unlocked.



S51PD ANSI F81
 Entrance Lock
 Unlocked by key from outside when outside lever is locked by turn-button in inside lever. Inside lever always unlocked.



S70PD ANSI F84
 Classroom Lock
 Outside lever locked and unlocked by key. Inside lever always unlocked.

Stocked Product:

FUNCTION	LEVER	FINISH
S10	Neptune	605,613,626
	Saturn	605,613,626
S40	Neptune	605,613,626
	Saturn	605,613,626
S51	Neptune	605,613,626
	Saturn	605,613,626
S70	Neptune	605,613,626
	Saturn	605,613,626
S80	Neptune	605,613,626
	Saturn	605,613,626

Schlage - L Locks

Standard Features:

Certification L9000: ANSI A156.13, 1994, Series 1000, Grade 1 Operational, Grade 1 Security, UL Listed for 3hour fire door (except L9076 and L9077). With Interchangeable Core Cylinders: Grade 2 Security

Case Size L9000: 4-7/16" x 6-1/6" x 1"; L400: 4-7/16" x 3-5/8" x 1"

Armor Front L9000: 1-1/4" x 8"; L400: 1-1/4" x 5-19/32"

Deadbolt 1" Throw stainless steel

Latchbolt 3/4" Throw stainless steel with anti-friction tongue

Strike L9000: 1-1/4" x 4-7/8" Square Corner, 1-3/16" lip, box

Backset 2-3/4"

Cylinder Cylinders are C Keyway, 6 Pin Cylinder Keyed 5, Supplied 5 Pin Key Blanks. Also available in Schlage Everest C123 keyway. Door Range 1-3/4"

L9010 ANSI F01

Passage Latch

Latchbolt retracted by knob/lever from either side at all times.



L9040 ANSI F22

Bath/Bedroom Privacy Lock Latchbolt retracted by knob/lever from either side unless outside is locked by inside turn piece. Turning inside knob/lever or closing door unlocks outside knob/lever. To unlock from outside, remove emergency button, insert emergency turn (furnished in access hole and rotate.)



L9050 ANSI F04

Office and Inner Entry Lock Latchbolt retracted by knob/lever from either side unless outside is made inoperative by key outside or by turning inside thumbturn. When outside is locked, latchbolt is retracted by key outside or by knob/lever inside. Outside knob/ lever remains locked until thumbturn is returned to vertical or unlocked by key. Auxiliary latch deadlocks latchbolt when door is closed.



L9070 ANSI F05

Classroom Lock

Latchbolt retracted by knob/lever from either side unless outside is locked by key. Unlocked from outside by key. Inside knob/lever always free for immediate exit. Auxiliary latch deadlocks latchbolt when door is closed.



L9080 ANSI F07

Storeroom Lock

Latchbolt retracted by key outside or by knob/lever inside. Outside knob/lever always inoperative. Auxiliary latch deadlocks latchbolt when door is closed.



L9453 ANSI F20

Entrance Lock

Latchbolt retracted by knob/lever from either side unless outside is locked by 20° rotation or thumbturn. Deadbolt thrown or retracted by 90° rotation of thumbturn. When locked, key outside or knob/lever inside retracts deadbolt and latchbolt simultaneously. Outside knob/lever remains locked until thumbturn is restored to vertical position. Throwing deadbolt automatically locks outside knob/lever. Auxiliary latch deadlocks latchbolt when door is closed.



L9456 ANSI F13

Corridor Lock

Latchbolt retracted by knob/lever from either side. Deadbolt thrown or retracted by key outside or inside thumbturn. Throwing deadbolt locks outside knob/lever. Turning inside knob/lever simultaneously retracts deadbolt and latchbolt and unlocks outside knob/lever.

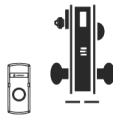

L9465

Closet/Storeroom Lock

Latchbolt retracted by knob/lever from either side. Deadbolt thrown or retracted by key outside.



L9480

Storeroom Lock With Deadbolt

Latchbolt retracted by key outside or by lever or knob inside. Outside knob/lever always fixed. Deadbolt thrown or retracted by key outside or thumbturn inside. Turning inside knob/lever simultaneously retracts both deadbolt and latchbolt. Auxiliary latch deadlocks latchbolt when door is locked. Inside knob/ lever is always free for immediate egress.



L9092EL/L9092EU

Electrically locking/unlocking outside lever, Outside cylinder (replaces L9080EL/EU)

Outside knob/lever continuously locked (EL) or unlocked (EU) by 12 or 24V DC. Latchbolt retracted by key outside or knob/lever inside. EL is fail safe (power failure allows outside knob/lever to retract latchbolt); EU is fail secure (power failure locks outside knob/lever). Aux latch deadlocks latchbolt when door is locked. Inside lever always free for immediate egress.



Schlage - L Locks

L Locks

03A
A ROSE 2-1/8" DIA.



06A
A ROSE 2-1/8" DIA.



17A
A ROSE 2-1/8" DIA.



Stocked Product
613, 625, 626

SEE PRICE PAGE FOR B ROSE (2-9/16" DIA.) SWAP



L Escutcheon Trim available with 03, 06, and 17 Levers

Stocked Product
626

L Locks - Parts

10-072 STANDARD STRIKE **L283-040 SPRING CAGE**

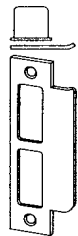

10-072
STANDARD STRIKE

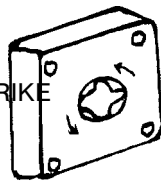

L9090 EL/E CHASSIS ONLY



L283-414 INDICATOR

Will work on:
L9050, L9070, L9080,
L9453, L9456



Stocked Products:

10-072	Strike, 1-1/4" X 4-7/8"	605, 613, 626
10-072-1-1/2"	Strike, 1-1/2" X 4-7/8"	613, 625, 626
L283-040	Spring Cage for Levers	
L283-412	RX module w/screw	
L9090LB	Chassis only EU/EL	
L283-414	Indicator- Occupied/Vacant	626



Schlage - *Electronic Locks*

CO 100 - Offline Electronic Lock

Standard Features:

- Manually Programmable
- Up to 500 unique 3-6 digit PIN codes stored on the lock
- ANSI/BHMA A156.25 Grade 1 certified and UL 294 listed
- Classroom/Storeroom function and Office function available
- Chassis options include cylindrical, mortise, and exit trim
- Compatible with most major brands of key systems and exit devices
- Normal, toggle, pass through, and freeze credential attributes available



Images shown are not to scale.

Stocked Products

ITEM #	DESCRIPTION	FINISH
CO-100-CY-70-KP-RHO	KEYPAD,STORAGE/CLASSROOM CYLINDER	626
CO-100-CY-50-KP-RHO	KEYPAD,OFFICE CYLINDER	626
CO-100-MS-70-KP-RHO	KEYPAD,STOREROOM/CLASSROOM MORTISE	626

Schlage - *Electronic Locks*

CO 200 - Offline Electronic Lock

Standard Features:

- Computer programmable with audit trail
 - Up to 2000 users & up to 2000 audits*
 - Up to 32 holidays & 16 time zones*
 - ANSI/BHMA A156.25 Grade 1 certified and UL 294 listed
 - User rights stored on the lock
 - The ability to add and delete users at the lock
 - Available in cylindrical, mortise, mortise deadbolt, and exit trim
 - Compatible with major brands of key systems and exit devices
 - Classroom/Storeroom, Office, and Privacy functions available
- *Depending on access control software.*



Images shown are not to scale.

Stocked Products

ITEM #	DESCRIPTION	FINISH
CO-200-CY-70-PRK-RHO	PAD/PROX, STORAGE/CLASSROOM CYLINDER	626
CO-200-MS-70-PRK-RHO	PAD/PROX, STOREROOM/CLASSROOM MORTISE	626



Schlage - *Electronic Locks*

CO-Series - Exit Trim

Standard Features:

- Multiple Credential Reader Options
- A wide variety of finishes and lever styles
- Powered by 4 AA batteries*
- Compatible with most Standard, FSIC or SFIC keyways from major brands of master key systems including Schlage, Sargent, Corbin, Medeco and Yale
- UL 294 listed and ANSI/BHMA 156.25 Grade 1 certified**

*Excluding 993DT

**UL 294 does not apply to dummy trim devices



Stocked Products

ITEM #	DESCRIPTION	FINISH
CO-100-993R-70-KP-RHO	EXIT TRIM, RIM/CVR	626
CO-100-993S-70-KP-RHO	EXIT TRIM, SVR	626
CO-200-993R-70-PRK-RHO	EXIT TRIM, RIM/CVR	626

Schlage

Cylinders & Tools

20-001 MORTISE CYLINDER 1-1/8" HAS L583-476, 1-1/4" HAS L583-477

09-485 MORTISE CYLINDER 1-1/8" HAS L583-474, 1-1/4" HAS L583-475

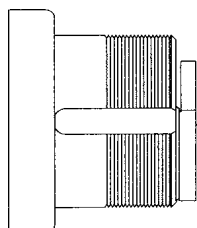
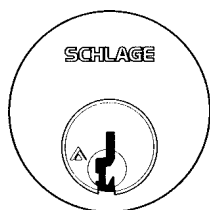

CYLINDER WITH COMPRESSION RING SPRING

STANDARD CAMS & VON DUPRIN CAMS

L583-476 L583-477

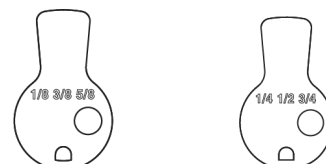

"L" LOCK CAMS

L583-474 L583-475



"A/R" CAMS

L583-446 L583-447



FOR 1-1/8", 1-3/8", 1-5/8"

FOR 1-1/4", 1-1/2", 1-3/4"

Stocked Product

CYLINDER TYPE	LENGTH	KEYWAY	FINISHES
20-001	1-1/8", 1-1/4"	C, E	605,613,625,626
20-001	1-3/8"	C, E	613,625
09-485	1-1/8", 1-1/4"	C, E	605,613,625,626
MCYL118EV(09-485)	1-1/8"	C123 EVEREST(EV)	605,613,625,626

20-022 - Rim Cylinders

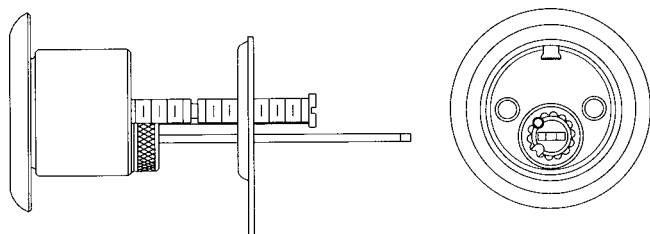

Stocked Product

CYLINDER TYPE	KEYWAY	FINISHES
20-022	C, E	605,613,626,626
20-022	C123(EV)EVEREST	613,626

40-100 Universal Cylinders For A, AL, D, H & ND Series

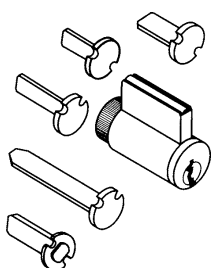

- A-series (all designs)
 - AL-series
 - D-series knobs
 - D-series levers
 - H-series knob (all designs)
 - ND-series levers
- Cylinders are furnished 0-bitted with two (2) blank keys

Stocked Product

CYLINDER TYPE	KEYWAY	FINISHES
40-100	C, E, C123, S123	606,626
40-100	CE, EF, F, FG, G	626

Schlage

Cylinders & Tools

23-030 Interchangeable Core

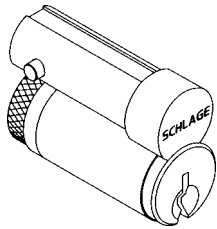

Stocked Product:

23-030	Keyways C,E	606,622,626
23-030	Keyway C123	606,626
23-030	Keyway S123	606,626
23-030	Keyway CE	626
23-030	Keyway E	626
23-030	Keyway F	626
23-030	Keyway G	626
23-030	Keyway FG	626
23-030	A622 Temp Core	622
48-056A	Temp Control Key	
48-101A	Temp Operating Key	
N523-127	Full Size Driver for ND Locks	
A700-052	Full Size Driver for AL Locks	

Mortise Cylinder - Full Size Interchangeable Core

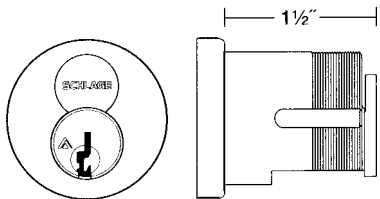

ITEM	CONTAINS	APPLICATION
26-091	Complete with compression ring & spring	Von Duprin straight cam
30-007	Housing only with compression ring & spring	L lock, L escutcheon
30-137	Housing only with compression ring & spring and 3/8" blocking ring	L lock, A & B rose
80-108	SFIC Housing only less compression ring & spring	L lock cam

Stocked Product:

26-091 Complete Cylinder, "C" "1" Bitted	613,626 Excludes Control Keys
30-007 Mortise Housing only F/Lock L Trim	613,626
30-137 Mortise Housing only F/Lock A Trim	613,625,626
80-108 Mortise Housing only, SFIC, With L Cam	613,626

Rim Cylinder - Full Size Interchangeable Core

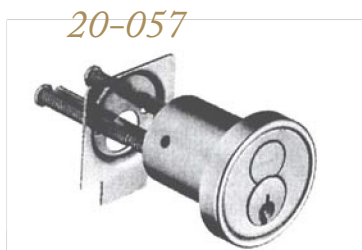

Stocked Product:

20-057	Keyway C	613,626
20-079	Rim Housing Only less core	613,626
80-129	Rim Housing Only, SFIC format	613,626
B507-899	Rim Cylinder Driver	

Schlage

Key Blanks

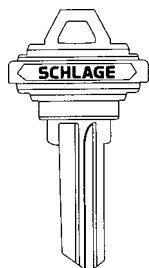

35-100
5 Pin Standard

35-101
6 Pin Standard

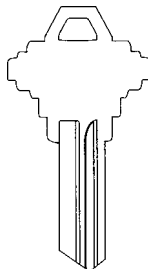

35-130
5 Pin Unembossed

35-131
6 Pin Unembossed

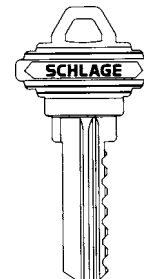

35-102
**Emergency
Key Blank**



35-009
Everest

35-270
Everest 29 S

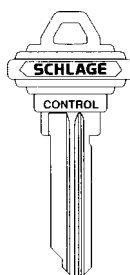

35-056
**Interchangeable Core
Control Key Blank**

35-003
**Everest
Control Key Blank**



35-269
**Everest
Control Key Blank**

Stocked Product

KEYBLANK	KEYWAY
35003	C123
35100	C, E, F
35101	C, CE, E, EF, FG
35130	E
35131	C, E, F
35009	C123, S123, C145
35056	C, CE, E, EF, F, G
35102	C, E
35269	S123
35270	S123

Pins & Misc.

Stocked Product

34-101,102,103 Top pins (100 per bag)
 34-202 thru 34-209 Master Pins (100 per bag)
 34-300 thru 34-309 Bottom pins (100 per bag)
 C503-113 Springs (100 per bag)
 34-401 Construction Balls

Schlage

Tools & Kits



40-119

Metal keying kit with tools

- Bottom pins
- Top pins
- Retainer caps
- Retainer cap pin springs
- Shim stock
- Follower bar
- Master pins
- Pin springs
- Retainer cap pins
- Tweezers

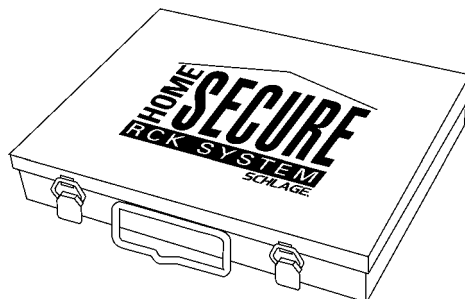

40-133

Home secure keying kit

- Bottom pins
- Top pins
- Removal tool
- Cylinder springs
- Retaining rings
- Retainer cap pin springs
- B-series cylinder bars
- B-series drivers
- Construction balls
- Master pins
- Follower bar
- Key gage
- tweezers
- Retainer caps
- Shim stock
- Retainer cap pins

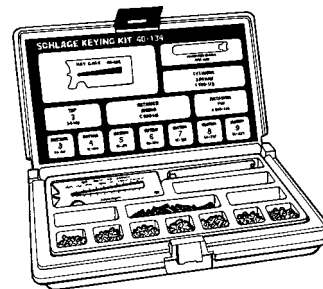

40-134

Plastic keying kit

- Bottom pins
- Top pins
- Follower bar
- Pin springs
- Retainer cap pins
- Key gage

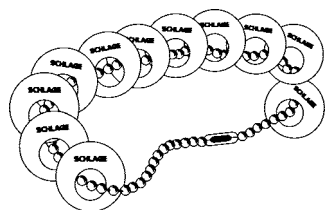

39-029

Finish selection kit

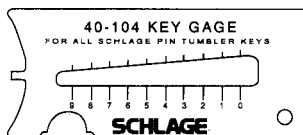

40-104

Standard

40-128 SFIC

Key gage



40-080

Thru bolt jig

Stocked Product

- | | |
|----------|--------------------------|
| 40-119 | Metal Keying Kit |
| 40-133 | Home Security Keying Kit |
| 40-134 | Plastic Keying Kit |
| 40-104 | Standard Key Gauge |
| 40-128 | SFIC Key Gauge |
| 40-080 | Thru Bolt Jig |
| 39-029 | Finish Selection Kit |
| M540-501 | Follower Tool |
| M540-056 | Cap Removal Tool |

Schlage



KS23D

Features & Specifications:

- Solid Brass Body Resists Corrosion For All Weather Performance
- Molybdenum Hardened Steel Shackle Offers Greater Cut Resistance
- Double Deadbolt Locking Mechanism Provides Extra Security
- Patented Interchangeable Shackle Design Allows For Easy Disassembly

Standard Cylinder Features Include:

- Schlage Conventional Key-In-Knob (KNK) Cylinder
- 6-Pin Solid Brass Cylinder (Pinned 5) Offers Increased Pick Resistance
- Two Nickel Silver Cut Schlage Keys

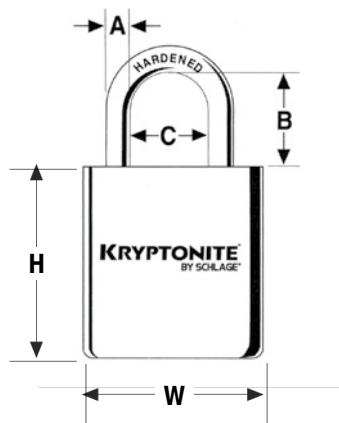

Kryptonite Brass Padlock

KS23D

ASTM Standards:

- Meets or exceeds ASTM standards for standard steel shackle, shackle cutting and corrosion resistance.

Body Size

W 1-25/32"

H 2-3/16"

Shackle Dimension

A 5/16"

B 1-1/2"

C 3/4"

Stocked Product

KS23D

C Keyway 606