

## Cavity Sliders

### CaviLock - CL200 Range

The CL200 is a durable range of sliding door hardware suitable for residential, commercial, and hospitality applications.



CL200 Privacy Snib  
Satin Nickel finish.

#### Features

- Passage, Privacy and Bi-Parting options are available in a range of finishes.
- Suitable for use on timber or aluminum doors.
- Integrated snib button allows more space in the side pull.
- Handles are not handed.
- Large finger pull has more depth for greater purchase.
- Simple installation with easy to follow instructions.



CL200 Bi-Parting  
Satin Nickel finish.

#### Dimensions

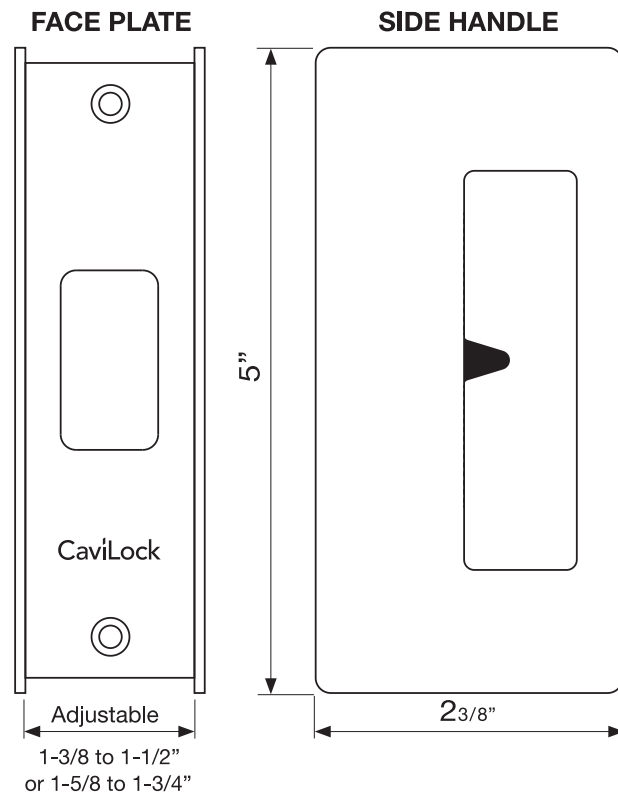

#### STRIKER

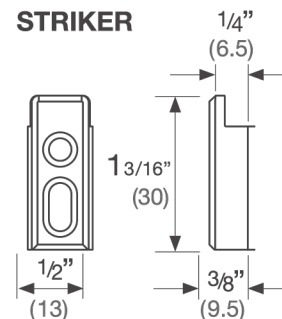

(CONTINUED ON NEXT PAGE)

## Cavity Sliders

### CaviLock - CL200 Range

#### Configurations

##### CL205 A - Passage (non-latching)

**Non-magnetic**

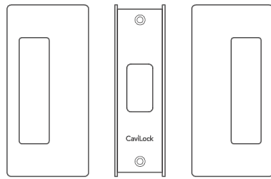

Passage handles are suitable for situations where locking or latching is not required. These handles do not have a striker or magnet.



SATIN CHROME

BRIGHT CHROME

SATIN NICKEL

OIL RUBBED BRONZE

MATTE BLACK

##### CL205 D - Privacy Snib/Emergency

**Magnetic Latch**

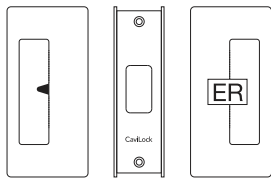

Privacy handles have a discreet triangular shaped snib button on one side and Emergency Release on the other side. They are suitable for sliding doors where latching is required.

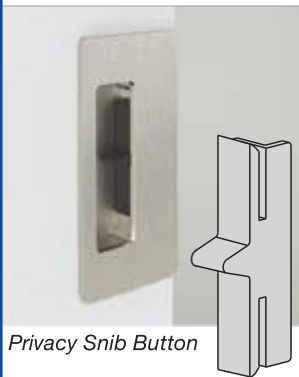

Privacy Snib Button



Emergency Release

##### CL205 C - Bi-Parting Mate (to latch with Privacy)

**Magnetic Latch**

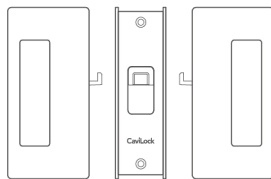

The Bi-Parting mate includes a striker on the face plate to enable it to magnetically latch with a privacy handle.

For Bi-Parting passage doors, order two single passage handles.

#### Stocked Product

##### PASSAGE - A

ITEM	DOOR THICKNESS	FINISH
CL205A0000	1-3/8"	BRIGHT CHROME
CL205A0001	1-3/8"	SATIN CHROME
CL205A0002	1-3/8"	ORB
CL205A0003	1-3/8"	SATIN NICKEL
CL205A0006	1-3/8"	MATTE BLACK
CL205A0015	1-3/4"	BRIGHT CHROME
CL205A0016	1-3/4"	SATIN CHROME
CL205A0017	1-3/4"	ORB
CL205A0018	1-3/4"	SATIN NICKEL
CL205A0021	1-3/4"	MATTE BLACK

##### PRIVACY - D

ITEM	DOOR THICKNESS	FINISH
CL205D0000	1-3/8"	BRIGHT CHROME
CL205D0003	1-3/8"	SATIN CHROME
CL205D0006	1-3/8"	ORB
CL205D0009	1-3/8"	SATIN NICKEL
CL205D0018	1-3/8"	MATTE BLACK
CL250D0030	1-3/4"	BRIGHT CHROME
CL205D0033	1-3/4"	SATIN CHROME
CL205D0036	1-3/4"	ORB
CL205D0039	1-3/4"	SATIN NICKEL
CL205D0048	1-3/4"	MATTE BLACK

##### BI-PARTING MATE - C

ITEM	DOOR THICKNESS	FINISH
CL205C0000	1-3/8"	BRIGHT CHROME
CL205C0001	1-3/8"	SATIN CHROME
CL205C0002	1-3/8"	ORB
CL205C0003	1-3/8"	SATIN NICKEL
CL205C0006	1-3/8"	MATTE BLACK
CL205C0015	1-3/4"	BRIGHT CHROME
CL205C0016	1-3/4"	SATIN CHROME
CL206C0017	1-3/4"	ORB
CL205C0018	1-3/4"	SATIN NICKEL
CL205C0021	1-3/4"	MATTE BLACK

## Cavity Sliders

### CaviLock - CL400 Passage, Magnetic Latching

The CL400 is a stylish architectural option for passage handles. Designed to complement the privacy and locking range, this handle features a positive hold close action to ensure the door doesn't bounce off the closing jamb.

#### Features:

- Magnetic latch ensures door doesn't roll away from the closing jamb.
- Passage hardware matches Privacy and Key Locking hardware.
- Door slides flush back into the pocket.

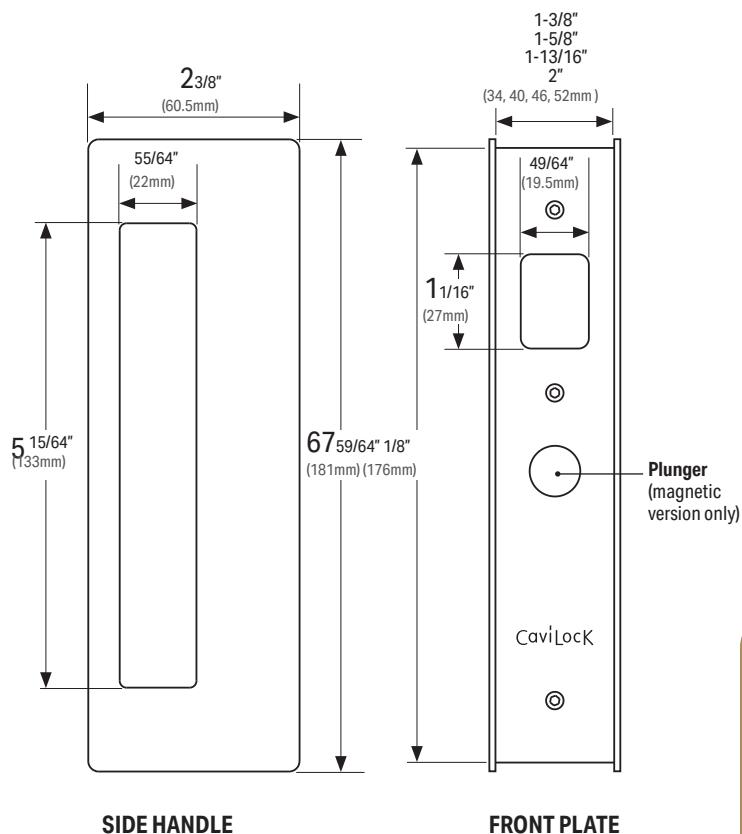

CL400 Passage (latching).  
Oil Rubbed Bronze finish.

#### Stocked Product

ITEM	DOOR THICKNESS	FINISH
CL400A0228	1-3/8"	ORB
CL400A0328	1-3/8"	SATIN NICKEL
CL400A0028	1-3/8"	BRIGHT CHROME
CL400A0229	1-3/4"	ORB
CL400A0329	1-3/4"	SATIN NICKEL
CL400A0129	1-3/4"	SATIN CHROME

### ZBC004 - T Guide



#### Stocked Product

ITEM	DESCRIPTION	FINISH
ZBC004	7/8" T guide	BLACK PLASTIC

## Cavity Sliders

### CaviLock - CL400 Privacy, Magnetic Latching

The CL400 Privacy option matches the other configurations in the range. The magnetic latching feature ensures the door doesn't roll open - even if the snib is not engaged.

#### Features:

- Privacy hardware matches Passage and Key Locking hardware.
- Door slides flush back into the pocket.
- Magnetic latch ensures door doesn't roll away from the closing jamb.
- Moving parts sit flush until the door closes to minimize wear.

#### HANDING CONFIGURATION

Handing is determined at time of manufacture and cannot be altered on site. Careful selection of handing options is required at time of order. See diagram for determining handing of functions.

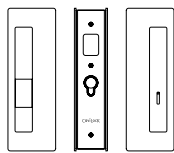
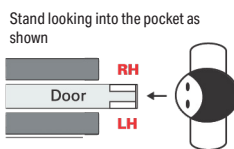

LH Snib/Emerg RH

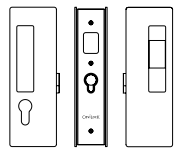

LH Key/Snib RH

**Example 1:** If the restroom was on your left shoulder you would want **LH Snib/RH Emergency**

**Example 2:** If the office was on your right shoulder you would want **LH Key/RH Snib**



CL400 Privacy Snib  
Satin Nickel finish.



CL400 Privacy -  
Emergency  
Release/Snib option.  
Emergency Release  
can be activated with a  
pen in an emergency.

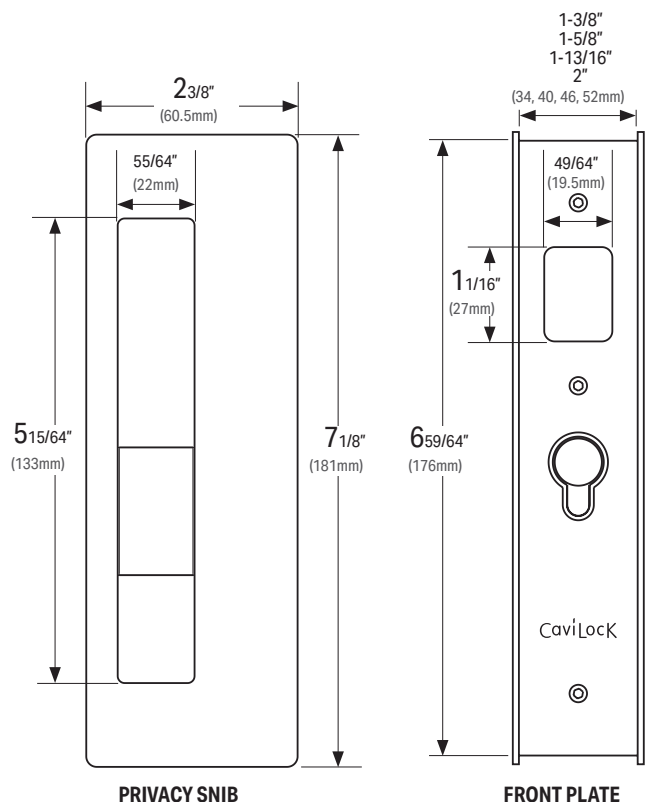
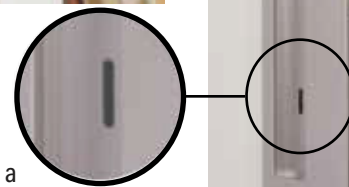

#### Stocked Product

##### LH EMERGENCY / SNIB RH

ITEM	DOOR THICKNESS	FINISH
CL400B0228	1-3/8"	ORB
CL400B0328	1-3/8"	SATIN NICKEL
CL400B0028	1-3/8"	BRIGHT CHROME
CL400B0233	1-3/4"	ORB
CL400B0333	1-3/4"	SATIN NICKEL
CL400B0033	1-3/4"	BRIGHT CHROME

##### RH EMERGENCY / SNIB LH

ITEM	DOOR THICKNESS	FINISH
CL400B0229	1-3/8"	ORB
CL400B0329	1-3/8"	SATIN NICKEL
CL400B0029	1-3/8"	BRIGHT CHROME
CL400B0129	1-3/8"	SATIN CHROME
CL400B0234	1-3/4"	ORB
CL400B0334	1-3/4"	SATIN NICKEL
CL400B0034	1-3/4"	BRIGHT CHROME
CL400B0134	1-3/4"	SATIN CHROME

## Cavity Sliders

### CaviLock - CL400 Locking & Magnetic Latching

The CL400 Key Locking option is suitable for residential or light commercial use in internal situations where medium security is required. It incorporates a single or double Euro Profile cylinder with Schlage C Keyway. All Key Locking handles come with a raised shroud as standard or increased security.\*

#### Features:

- Raised shroud included as standard for increased security.
- Key Locking hardware matches Passage and Privacy hardware.
- Door slides flush back into the pocket.
- Magnetic latch ensures door doesn't roll away from the closing jamb.
- Moving parts sit flush until the door closes to minimize wear.

#### HANDING CONFIGURATION

Handing is determined at time of manufacture and cannot be altered on site. Careful selection of handing options is required at time of order. See diagram for determining handing of functions.

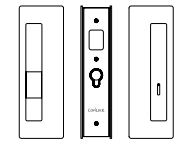
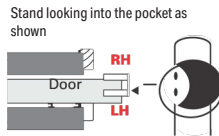

LH Snib/ Emerg RH

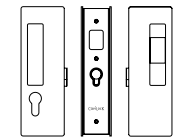

LH Key/Snib RH

**Example 1:** If the restroom was on your left shoulder you would want **LH Snib/RH Emergency**

**Example 2:** If the office was on your right shoulder you would want **LH Key/RH Snib**



CL400 Key Option  
Satin Nickel finish.



CL400 Key/Snib option.  
Oil Rubbed Bronze finish.

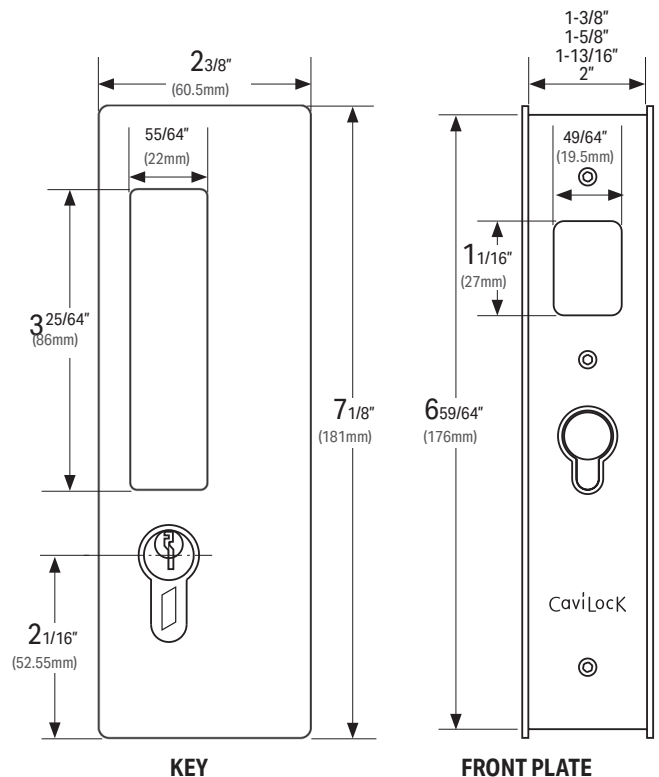

#### Stocked Product

##### LH SNIB / KEY RH

ITEM	DOOR THICKNESS	FINISH
CL400C0227	1-3/8"	ORB
CL400C0127	1-3/8"	SATIN CHROME
CL400C0137	1-3/4"	SATIN CHROME

##### RH SNIB / KEY LH

ITEM	DOOR THICKNESS	FINISH
CL400C0228	1-3/8"	ORB
CL400C0328	1-3/8"	SATIN NICKEL
CL400C0338	1-3/4"	SATIN NICKEL
CL400C0138	1-3/4"	SATIN CHROME

## Cavity Sliders

### CaviLock - CL400 Bi-Parting (Double Door) Set

The CL400 Bi-Parting set is suitable for use where two doors meet in the middle. The positive hold close action brings the doors together smoothly and holds them together until ready to open.

#### Features:

- Options include Passage and Privacy
- Bi-Parting hardware matches other hardware in the range.
- Doors slide flush back into the pocket.
- Moving parts sit flush until the door closes to minimize wear.
- Suits doors from 1-3/8" to 1-3/4" thick.

#### Configurations

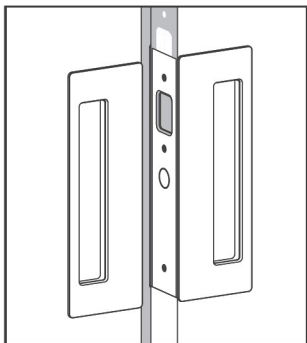

Passage - latching

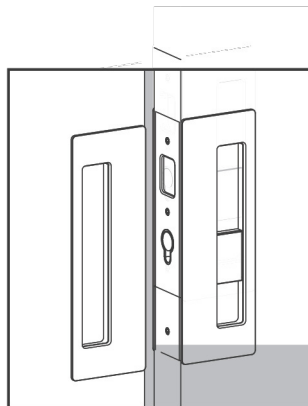

Privacy



CL400 Bi-Parting Privacy Emergency/Snib option. Satin Nickel finish.

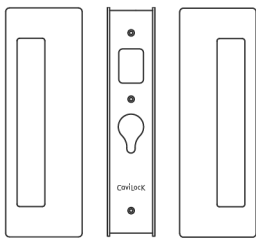

Matching Handle Set  
Passage/Privacy

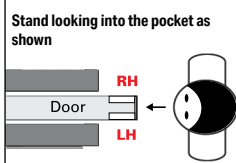

#### Stocked Product

##### PASSAGE

ITEM	DOOR THICKNESS	FINISH
CL400D0128	1-3/8"	SATIN CHROME
CL400D0228	1-3/8"	ORB
CL400D0129	1-3/4"	SATIN CHROME

##### PRIVACY Emergency/Snib

ITEM	DOOR THICKNESS	FINISH
CL400D0338	1-3/8"	SATIN NICKEL
CL400D0143	1-3/4"	SATIN CHROME

## Cavity Sliders

### CaviLock - Technical Detail

#### FACE PLATE

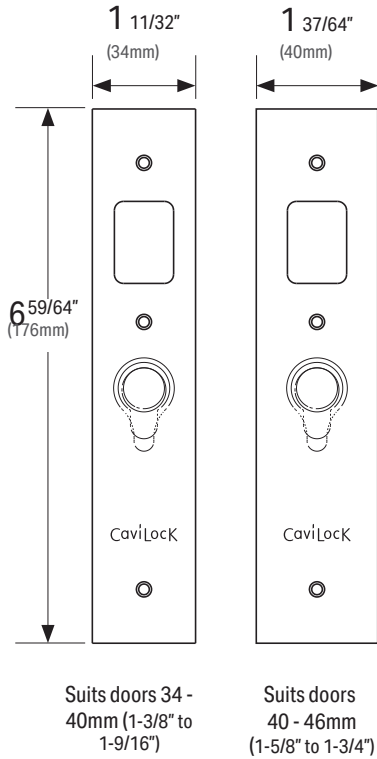

#### DOOR CUTOUT

The CL400 requires a simple door cut out. Complete instructions and templates are supplied with every handle.

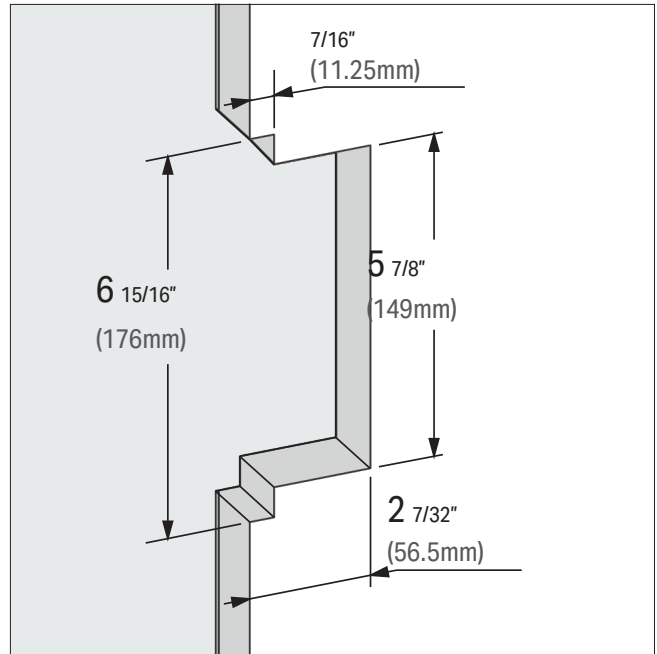

#### STRIKER

Depending on the configuration of the handle, the striker supplied is designed to either sit flush with the face of the closing jamb or recessed into the closing jamb. Striker cutout template and instructions are supplied with your handle and cover installation into a flush or recessed closing jamb.

#### Recessed striker - Privacy/Key Locking handles

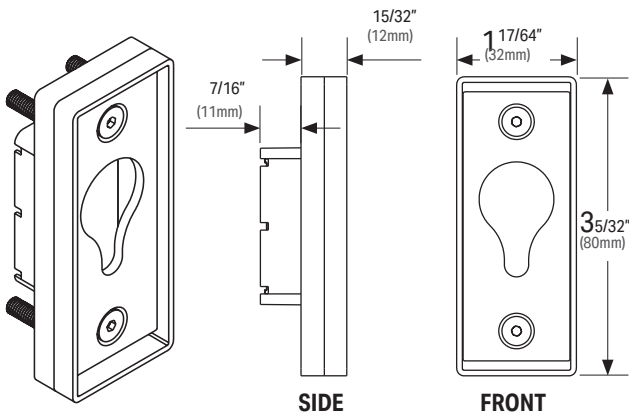

#### Flush striker - Passage handles

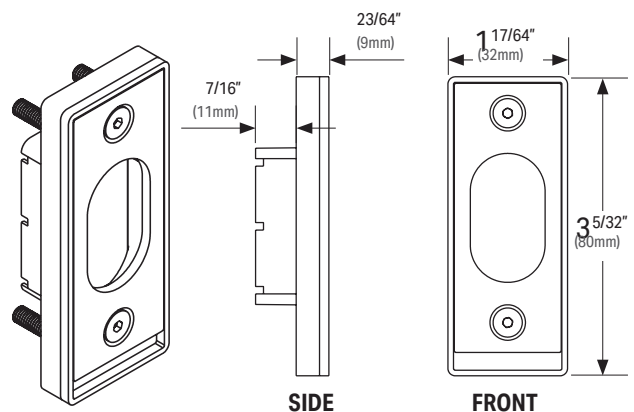

Dimensions shown in inches (and millimeters).

## Cavity Sliders CaviLock - CL400 ADA Magnetic Offset

The new CL400® ADA Magnetic matches the look and functionality of the existing CL400 Magnetic range of pocket door hardware, with added ADA functionality.

Utilizing the patented magnetic mechanism of the CL400 Magnetic, this new addition to the range provides flexibility for building owners. The CL400 ADA uses the same door cutout and striker and is able to be retrofitted over existing CL400 flush handles for the requirements of ADA tenants.

The CL400 ADA is compatible with egress applications.

In line with ADA Standards for Accessible Design, the CL400 ADA Magnetic has a handle that is easy to grasp with one hand and does not require tight grasping, tight pinching or twisting of the wrist.

### Features:

- Easy to use - no tight pinching or twisting of the wrist.
- Patented magnetic functionality.
- Striker sits flush with closing jamb.
- See at a glance whether a room is occupied.
- Matches other hardware in the CL400 range.

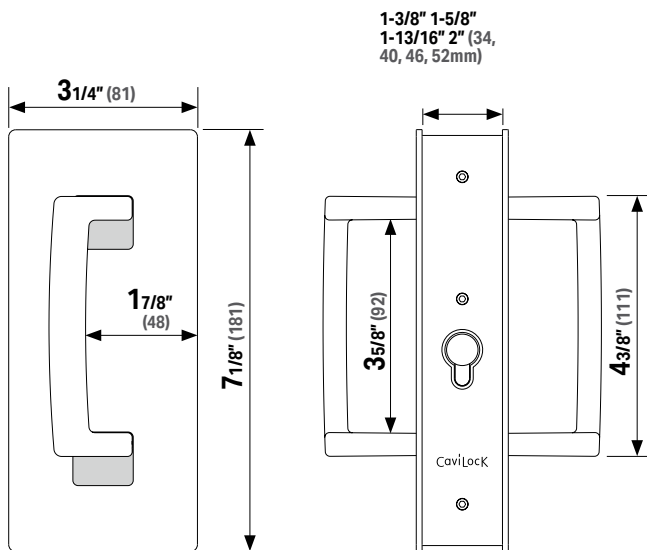

1-3/8" 1-5/8"  
1-13/16" 2" (34, 40, 46, 52mm)

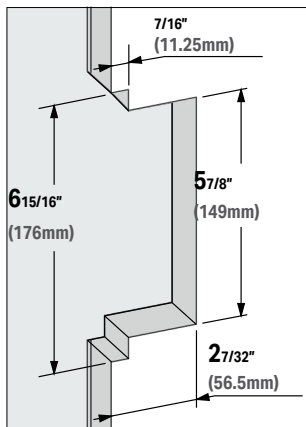

**IMPORTANT:** Operable parts of hardware must be mounted 34" (865mm) min. and 48" (1220 mm) max. above finished floor to meet ADA guidelines. The clear width of the door opening must be a minimum of 32". Always check State and Federal guidelines relating to the specific project.



CaviLock CL400 ADA Privacy with Emergency Release



CL400 ADA Privacy Snib in satin nickel finish.

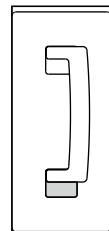

Privacy

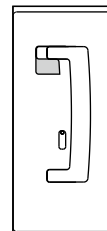

Emergency Release

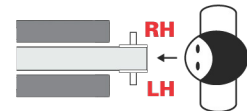

Handing must be determined at time of manufacture and cannot be altered on site. Careful selection of handing options is required at time of order. See diagram for determining handing of functions.

### Stocked Product

#### LH EMERGENCY / SNIB RH

ITEM	DOOR THICKNESS	FINISH
CL406B0128	1-3/8"	SATIN CHROME
CL406B0328	1-3/8"	SATIN NICKEL
CL406B0133	1-3/4"	SATIN CHROME
CL406B0233	1-3/4"	ORB
CL406B0333	1-3/4"	SATIN NICKEL

#### RH EMERGENCY / SNIB LH

ITEM	DOOR THICKNESS	FINISH
CL406B0129	1-3/8"	SATIN CHROME
CL406B0329	1-3/8"	SATIN NICKEL
CL406B0034	1-3/4"	BRIGHT CHROME
CL406B0134	1-3/4"	SATIN CHROME
CL406B0334	1-3/4"	SATIN NICKEL